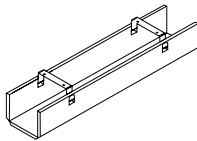

STORAGE

EVAFWMXXP - WIRE MANAGER

- PET Wire manager installed under worksurface
- Including attachment brackets
- Available in standard felt colors

DESCRIPTION	PRODUCT CODE	LIST PRICE	DIMENSIONS/INCHES		
			H	W	D
 PET Wire Manager	EVAFWM22P	128	3.375	22	4
	EVAFWM28P	147	3.375	28	4
	EVAFWM34P	162	3.375	34	4

EVAFWMXXPL - WIRE MANAGER FOR 90 DEGREE CORNER-LEFT

- PET Wire manager installed under worksurface
- Including attachment brackets
- Available in standard felt colors

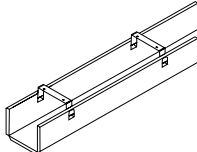
DESCRIPTION	PRODUCT CODE	LIST PRICE	DIMENSIONS/INCHES		
			H	W	D
 PET Wire Manager 90 Degree Corner - Left	EVAFWM26PL	141	3.375	26	4
	EVAFWM32PL	158	3.375	32	4
	EVAFWM38PL	172	3.375	38	4

EVAFWMXXPR - FELT WIRE MANAGER FOR 90 DEGREE CORNER-RIGHT

- Felt Wire manager installed under worksurface
- Including attachment brackets
- Available in standard felt colors

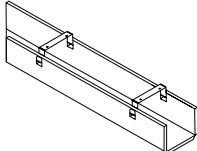
DESCRIPTION	PRODUCT CODE	LIST PRICE	DIMENSIONS/INCHES		
			H	W	D
 PET Wire Manager 90 Degree Corner - Right	EVAFWM26PR	141	3.375	26	4
	EVAFWM32PR	158	3.375	32	4
	EVAFWM38PR	172	3.375	38	4



STORAGE

EVSDAOH - POWER BEAM DUAL ACCESS OVERHEAD

- Inside dimensions 6.500"high x 13"deep
- Laminate Overhead
- Available in standard Evolve laminate finishes
- Top mount on power beam
- Dual Access Overhead Support Brackets to be ordered separately
- Horizontal tube with trim and power beam legs for storage to be ordered separately
- Power Beam shared storage cabinet must be installed at bottom for stability
- Power beam legs for storage must be used

DESCRIPTION	PRODUCT CODE	LIST PRICE	DIMENSIONS/INCHES		
			H	W	D
Dual Access Overhead	EVSDAOH60	1336	8.5	60	16
	EVSDAOH72	1357	8.6	72	16

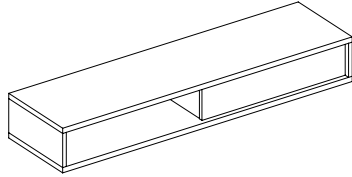

EVPBSCGD - POWER BEAM SHARED STORAGE CABINET WITH SLIDING GLASS DOOR

- Inside dimensions 13"high x 13"deep
- Laminate storage cabinet, available in standard Evolve laminate finishes
- Available in Temperete Frosted Glass only, glass with hole to pull
- Tracks for sliding glass available in Tungsten only
- To be used with 24" H Power beam only
- To be installed under power beam between T legs
- Power Beam Storage cabinet attaches to bottom of power beam with brackets
- For ease of installation, levelers in middle included

DESCRIPTION	PRODUCT CODE	LIST PRICE	DIMENSIONS/INCHES		
			H	W	D
Storage Cabinet with Sliding Glass Right	EVPBSCGDR60	2008	15	58.75	16
	EVPBSCGDR72	2240	15	70.75	16
Storage Cabinet with Sliding Glass Left	EVPBSCGDL60	2008	15	58.75	16
	EVPBSCGDL72	2240	15	70.75	16

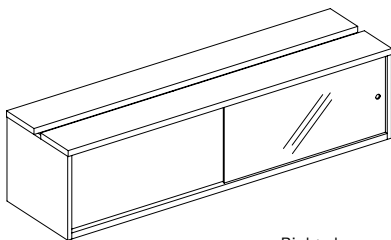

Right shown
(opening on right)

STORAGE

EVPBSCP - POWER BEAM STORAGE CABINET AND CABLE PASS THROUGH

- Inside dimensions 13" high x 13" deep
- Laminate storage cabinet, available in standard Evolve laminate finishes
- To be used with 24" H Power beam only and 60" and 72" widths only
- To be installed under power beam between two T legs
- Power Beam Storage cabinet attaches to bottom of power beam with brackets
- For ease of installation, levelers in middle included
- Cabinet with cable pass through in middle to bring power to power beam above
- Includes metal cover for easy access to wires
- Electrics not included
- Power beam base feed to be ordered separately
- Power beam kit with electrical cut out in middle to be ordered separately (EVPBEPxxKIT see page 7 or EVPBEPxxKIT01 see page 8)

DESCRIPTION	PRODUCT CODE	LIST PRICE	DIMENSIONS/INCHES		
			H	W	D
Storage Cabinet Right	EVPBSCP60	1798	15	58.75	16
	EVPBSCP72	1901	15	70.75	16
Storage Cabinet Left	EVPBSCPL60	1798	15	58.75	16
	EVPBSCPL72	1901	15	70.75	16

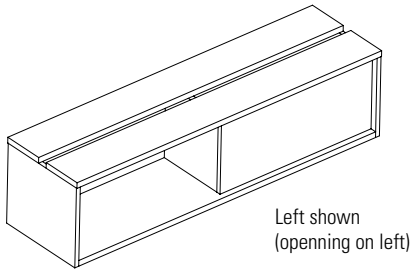

**NOTE: Can not be converted to cabinet with glass door.
To be used with 24" H Power Beam only**

EVPBSCGDP - POWER BEAM STORAGE CABINET WITH SLIDING GLASS DOOR AND CABLE PASS THROUGH

- Inside dimensions 13" high x 13" deep
- Laminate storage cabinet, available in standard Evolve laminate finishes
- Available in Tempered Frosted Glass only, with handle
- Tracks for sliding glass available in Tungsten only
- To be used with 24" H Power beam only and 60" and 72" widths only
- To be installed under power beam between two T legs
- Power Beam Storage cabinet attaches to bottom of power beam with brackets
- For ease of installation, levelers in middle included
- Cabinet with cable pass through in middle to bring power to power beam above
- Includes metal cover for easy access to wires
- Electrics not included
- Power beam base feed to be ordered separately
- Power beam kit with electrical cut out in middle to be ordered separately (EVPBEPxxKIT see page 7 or EVPBEPxxKIT01 see page 8)

DESCRIPTION	PRODUCT CODE	LIST PRICE	DIMENSIONS/INCHES		
			H	W	D
Storage Cabinet with Sliding Glass Right	EVPBSCGDP60	3043	15	58.75	16
	EVPBSCGDP72	3217	15	70.75	16
Storage Cabinet with Sliding Glass Left	EVPBSCGDPL60	3043	15	58.75	16
	EVPBSCGDPL72	3217	15	70.75	16

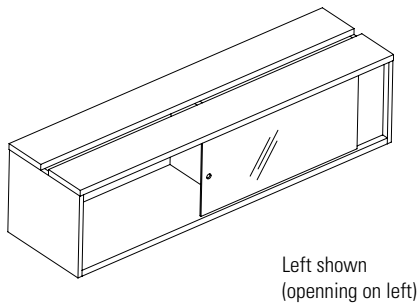

NOTE: To be used with 24" H Power Beam only



STORAGE

VPBL - 36" H POWER BEAM CONNECTOR WITH LEG FOR STORAGE

- Connects 24" H power beams on equal height
- Includes non slotted connector with leg, glides and connecting hardware
- Horizontal tube to be ordered separately
- Must be used with overhead

DESCRIPTION	PRODUCT CODE	LIST PRICE	DIMENSIONS/INCHES		
			H	W	D
Connector with Leg for Storage	EVPBL36S	120	36	18	16

