

panels

TECHNICAL FEATURES OF EVOLVE PANELS:

- Evolve Panels are 2 7/8" thick.
- An aluminum low profile top cap is included with the panel.
- Base Raceway will allow for 140 data cables without electrical, or 48 data cables with electrical.
- Beltline Raceway will allow for 65 data cables without electrical or 54 data cables with electrical.
- 90 degree post extension will allow for 45 data cables without electric and 25 data cables with electric.
- Raceway knockout openings are 1.38" x 2.71".
- Acoustic Rating: .65 = NRC - Noise Reduction Coefficient
- STC: 23 = Sound Transmission Coefficient

BASIC FEATURES OF EVOLVE PANELS:

- Evolve Segmented Panels are available in four (4) basic heights: 30", 42", 54" and 66"; and eight (8) widths: 18", 24", 30" 36", 42", 48", 54" High and 60".
- Evolve Monolithic Panels are available in four (4) basic heights: 42", 48", 54" and 66"; and eight (8) widths: 18", 24", 30" 36", 42", 48", 54" and 60".
- Evolve Panels must include the same segmentation on both sides of the panel. Cannot be Monolithic on one side and Segmented on the other.
- Opposite sides of each Fabric Module may have a different fabric within the same grade at no upcharge.
- If different grades of fabric are used on one panel, the entire panel must be priced at the highest grade.
- There is no panel creep in a straight Panel-to-Panel configuration; however, a corner post (2, 3, 4 way) will add 3.25" inches to a panel run.
- All Fabric Acoustic Panels (EVPFA) are composed of a 6" raceway module and a 24" base-height module which create the EVPFA30. Subsequent heights are created by adding either a 12" high module to create an EVPFA42 or a 24" high module to create an EVPFA54. The addition of both 12" and 24" modules creates a EVPFA66.
- In contrast, a Premium Panel (EVFPF) is composed of a 6" raceway module, a 24" base-height module and either two (2) or three (3) 12" modules which make up the two premium heights: EVFPF54 and EVFPF66.
- All Panels available with Aluminum trim as a standard option.
- Individual fabric covered acoustic modules incorporated into a rigid steel frame.
- Raceway covers included with panels
- Beltline Panels contain a 6" Power Belt Module that is metal with knockouts on both sides.

BASIC FEATURES OF EXTENSION MODULES:

- Stackability: Evolve Panels can be increased in height in 6", 12", 18" or 24" increments. See Extension Module (pages 82-90) for part numbers.
- Panel Extension Modules stack on the top of a Panel.
- Modules can be stacked to add privacy or divide space.
- Opposite sides of a fabric module may have a different fabric within the same grade at no upcharge.
- If different grades of fabric are used on one Panel, the entire Module must be priced at highest grade.

GENERAL WARRANTY INFORMATION:

- Panel and tackboard textiles, adjustable keyboard mechanisms, tasklights and electrical devices = ten (10) Years
- Other parts = Lifetime Warranty



MONOLITHIC PANELS - PAGES 22-27

Monolithic Panel

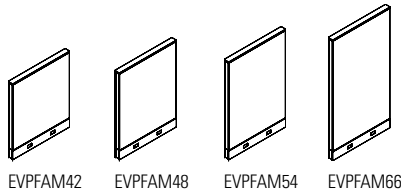

Monolithic Light Panel

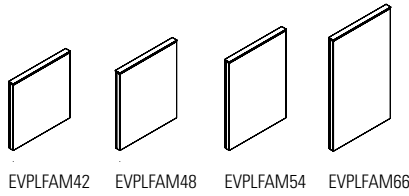

Monolithic Beltline Powered Panel

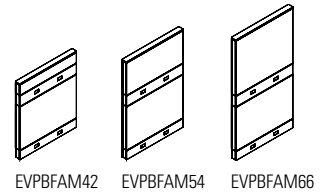

Monolithic Beltline Powered Light Panel

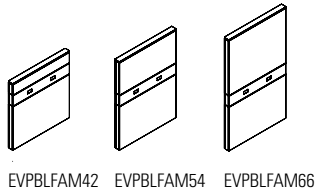

Monolithic Beltline Powered Chimney Panel

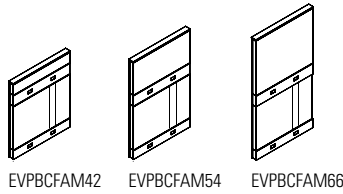

Chimney Jumper Cable Kit

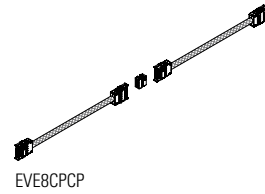

Monolithic Beltline Non-Powered Panel

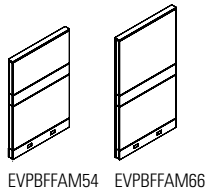

Monolithic Beltline Non-Powered Light Panel

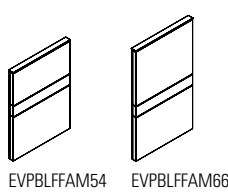

SEGMENTED PANELS - PAGES 28-33

Segmented Panel

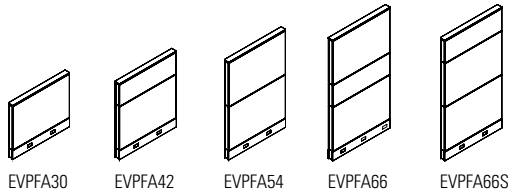

Segmented Light Panel

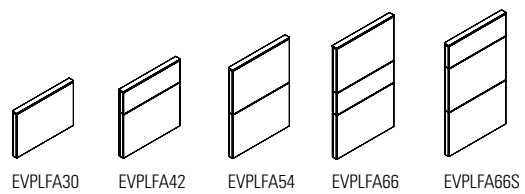

Segmented Premium Panel

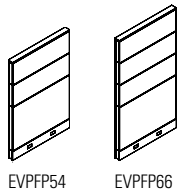

Segmented Premium Light Panel

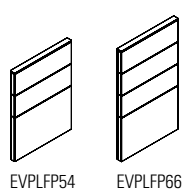

Segmented Beltline Powered Panel

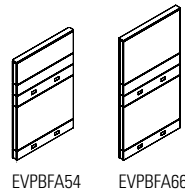

Segmented Beltline Powered Light Panel

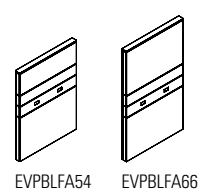

Segmented Beltline Powered Chimney Panel

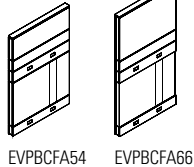

Chimney Jumper Cable Kit

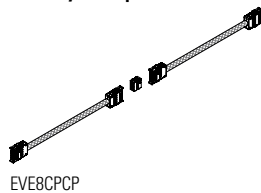

Segmented Beltline Non-Powered Panel

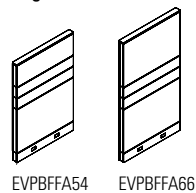

Segmented Beltline Non-Powered Light Panel

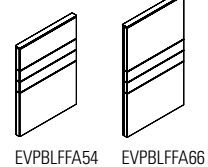

PARTLY GLAZED - TEMPERED GLASS PANELS - PAGES 34-43

Monolithic 12"H Glazed Panel

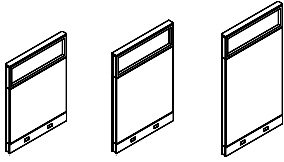

EVPMGTU48 EVPMGTU54 EVPMGTU66

Monolithic 12"H Glazed Light Panel

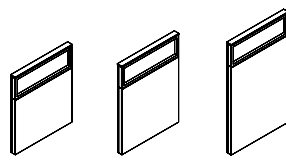

EVPLMGTU48 EVPLMGTU54 EVPLMGTU66

Segmented 12"H Glazed Panel

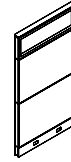

EVPPGTU66

Segmented 12"H Glazed Light Panel

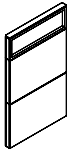

EVPLFGTU66

Segmented 12"H Glazed Premium Panel

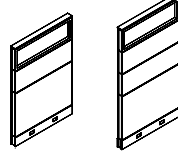

EVPPFGTU54 EVPPFGTU66

Segmented 12"H Glazed Premium Light Panel

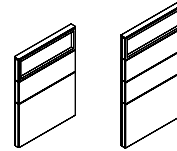

EVPLFGTU54 EVPLFGTU66

Partly Glazed Panel

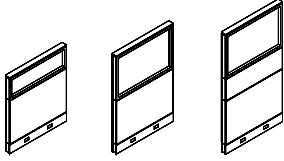

EVPGT42 EVPGT54 EVPGT66

Partly Glazed Light Panel

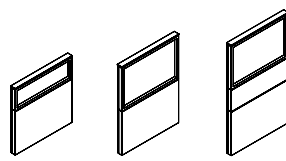

EVPLFGT42 EVPLFGT54 EVPLFGT66

Partly Glazed Panel - 36"H



EVPGTX66

Partly Glazed Light Panel - 36"H

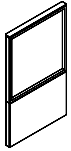

EVPLFGTX66

Partly Glazed Beltline Powered Panel

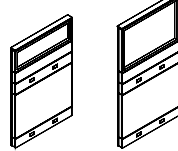

EVPPBFGT54 EVPPBFGT66

Partly Glazed Beltline Powered Light Panel

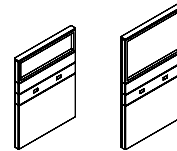

EVPPBFGT54 EVPPBFGT66

Partly Glazed Beltline Powered Chimney Panel

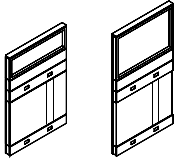

EVPPBCFGT54 EVPPBCFGT66

Chimney Jumper Cable Kit

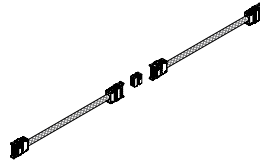

EVE8CPCP

Partly Glazed Premium Panel

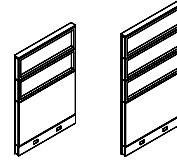

EVPPFGT54 EVPPFGT66

Partly Glazed Premium Light Panel

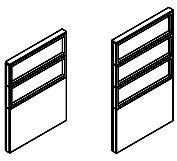

EVPLFGT54 EVPLFGT66



FULLY GLAZED - TEMPERED GLASS PANELS - PAGES 44-47

Fully Monolithic Panel

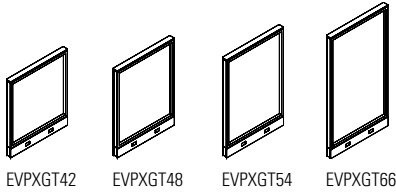

Fully Monolithic Light Panel

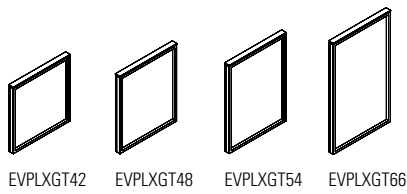

Fully Glazed Segmented Panel



Fully Glazed Segmented Light Panel

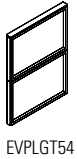

Fully Glazed Premium Panel

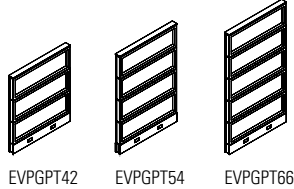

Fully Glazed Premium Light Panel

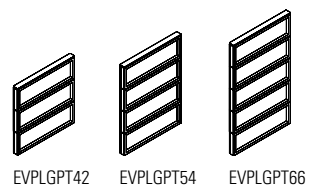

PASS-THRU SLIDING DOOR - PAGES 50-51

Pass-Thru Sliding Door Glazed Panel

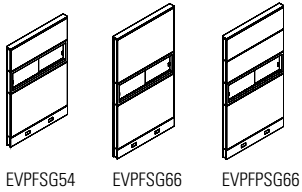

Fabric Glazed Pass-Thru Sliding Door Panel

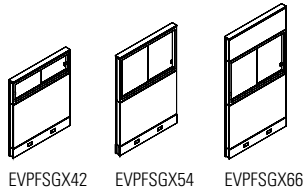

SLATWALL PANELS - PAGES 52-58

Slatwall Panel - Single Sided

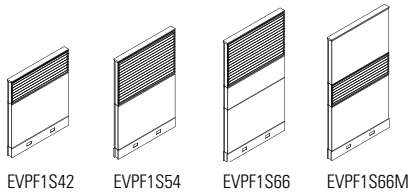

Slatwall Light Panel - Single Sided

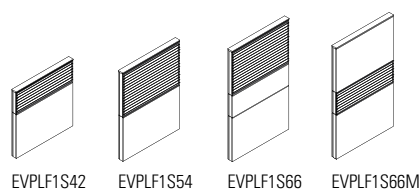

Slatwall Panel - Double Sided

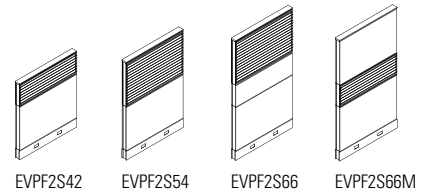

Slatwall Light Panel - Double Sided

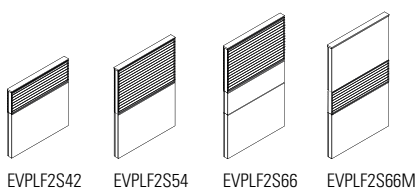

Frameless Slatwall Panel - Double Sided

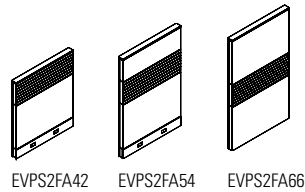

Frameless Slatwall Beltline Powered Panel - DS

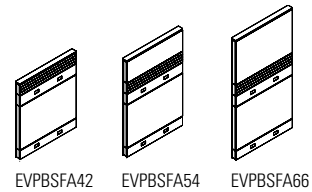

Frameless Slatwall Beltline Powered Light Panel - DS

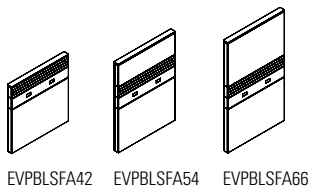

Frameless Slatwall Beltline Powered Chimney Panel - Double Sided

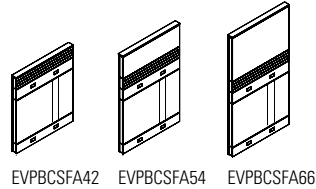

Chimney Jumper Cable Kit

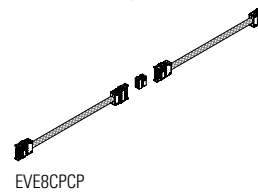

WRITE BOARD PANELS - PAGES 59-60

Write Board Panel - Single Sided

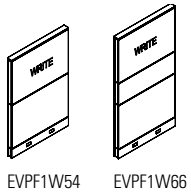

Write Board Light Panel - Single Sided

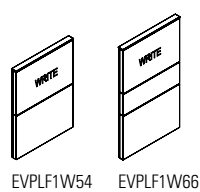

Write Board Panel - Double Sided

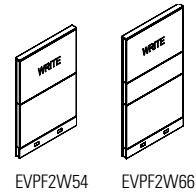

Write Board Light Panel - Double Sided

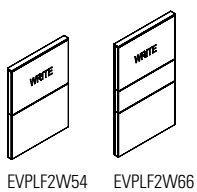

LAMINATE PANELS - PAGES 61-64

Laminate Panel - Single Sided

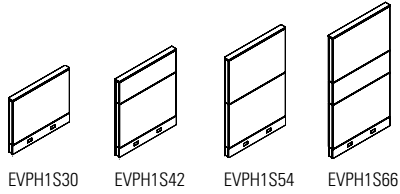

Laminate Light Panel - Single Sided

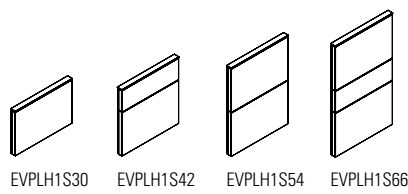

Laminate Panel - Double Sided

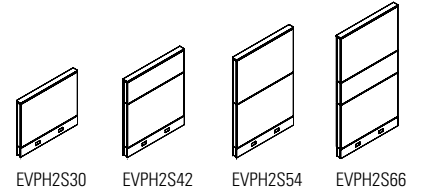

Laminate Light Panel - Double Sided

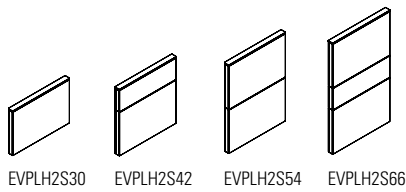

AIRFLOW PANELS - PAGES 65-68

Airflow Panel

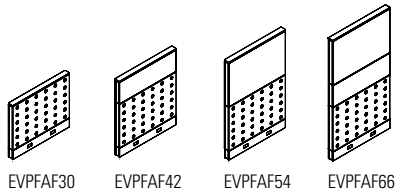

Airflow Light Panel

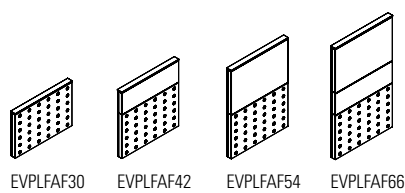

Airflow Premium Panel

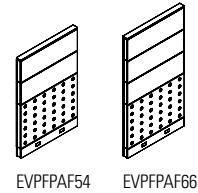

Airflow Premium Light Panel

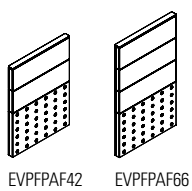

Airflow Middle Premium Light Panel

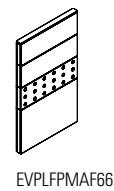

METAL SKIN PANELS - PAGES 69-72

Metal Skin Panel - Single Sided

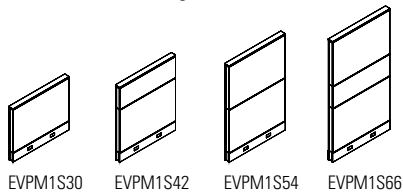

Metal Skin Light Panel - Single Sided

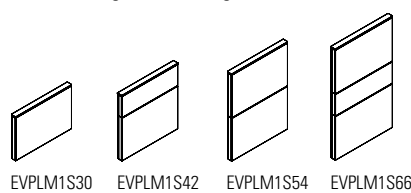

Metal Skin Panel - Double Sided

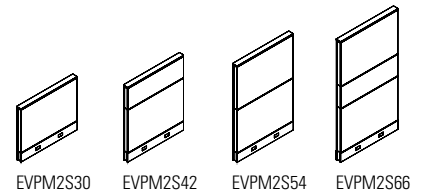

Metal Skin Light Panel - Double Sided

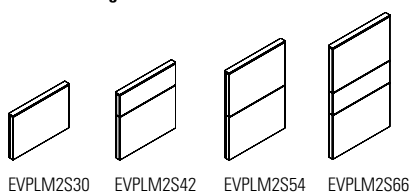

OPEN PANELS - PAGES 73-78

Open Bottom Panel

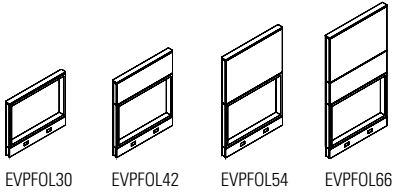

Open Bottom Light Panel

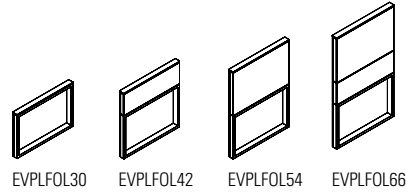

Open Bottom Premium Panel

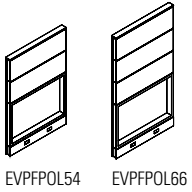

Open Bottom Premium Light Panel

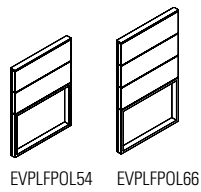

Open Middle Panel - 12"H Opening

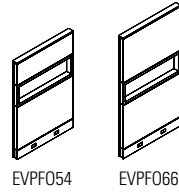

Open Middle Light Panel - 12"H Opening

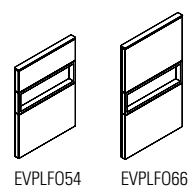

Open Middle Premium Panel - 12"H Opening

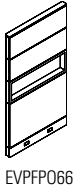

Open Middle Premium Light Panel - 12"H Opening

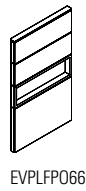

Open Middle Panel - 24"H Opening

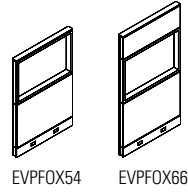

Open Middle Light Panel - 24"H Opening

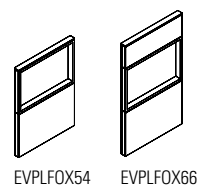

NO RACEWAY PANELS - PAGES 79-91

Segmented

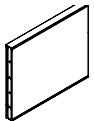

EVPFA3018NR

Monolithic

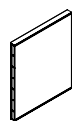

EVPFAM4218NR

Laminate - Single Sided

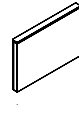

EVPH1S3018NR

Laminate - Double Sided

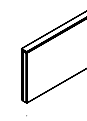

EVPH2S3018NR

Fully Glazed Monolithic

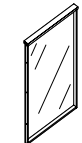

EVPXGT9018NR

Inline Connector

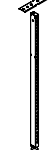

EVPIC30NR

End of Run

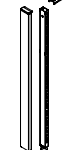

EVPERA30NR

Corner Post - One Way

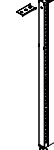

EVPCPA130NR

Inline Corner Post - Two Way

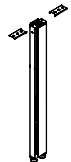

EVPIPA230NR

Corner Post - Two Way

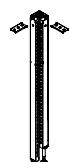

EVPCPA230PNR

Corner Post - Three Way

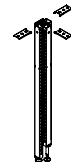

EVPCPA330PNR

Corner Post - Four Way

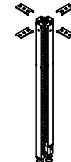

EVPCPA430PNR



GALLERY PANELS - PAGES 92-105

Laminate Double Sided Finished Ends



EVLEPDS4251NC

Laminate Double Sided Connector Ends



EVLEPDS4251

Laminate Single Sided Finished Ends



EVLEPSSL4227NC

Laminate Double Sided Connector Ends



EVLEPSSL4227

Laminate Double Sided Middle Base Power, Finished Ends



EVLEPDC4251NC

Laminate Double Sided Middle Beltline Power, Finished Ends



EVICLXP4251NC

Laminate Double Sided Base Power, Connector Ends



EVLEPDC4251

Laminate Double Sided Middle Beltline Power, Connector Ends



EVICLXP4251

Laminate Single Sided Middle Base Power, Finished Ends



EVLEPSC4227NC

Laminate Single Sided Middle Base Power, Connector End



EVLEPSC4227

Laminate Single Sided Middle Beltline Power, Finished Ends



EVLEPSCB4227NC

Laminate Single Sided Middle Beltline Power, Connector End



EVLEPSCB4227

Laminate Gallery Extension Finished End



EVLXPML4224NC

Laminate Gallery Straight Extension, Connector Ends



EVLXPML4224

Laminate Gallery Two-Way Extension, Finished Ends



EV2LXPL4225

Laminate Gallery Three-Way Extension, Finished Ends



EV3LXPL4249

Laminate Double Gallery for Four-Way, Finished Ends



EV4LXP4249

Laminate Extension Panel for Four-Way, Finished Ends



EV4LXPM4224

Panel Connector with U Channel



EVVBERCH42

Panel Connector w/U Channel For Beltline Panels



EVVBERCH42

Laminate Gallery Panel Bottom Bracket



EVHLPBB01

Laminate Gallery Panel Corner Bracket



EVHLPBB01

Connector w/U Channel Top Trim Aluminum



EVPTTAU24

1" LAMINATE PANELS - PAGES 106-108

1" Laminate End Panel

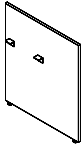

EVLEPR42

1" Laminate Middle Panel

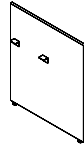

EVLMP42

1" Laminate End Panel w/ Accessory Rail

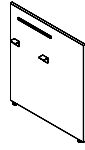

EVLEPR42A

1" Laminate Middle Panel w/ Accessory Rail



EVLMP42A

Double Inline Panel Connector

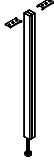

EVPDIC42

Beltline DoubleInline Panel Connector

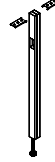

EVBDIC42

Double Inline Connector Trim

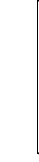

EVPDVTF42

Double Inline Panel Connector Top Trim - Aluminum

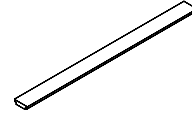

EVPTTA25

DOOR PANELS - PAGES 110-112

Door Panel - Solid

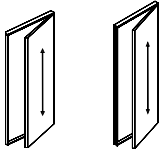

EVPS84

EVPS90

Knob Lock Set



EVPSL01

Lever Lock Set



EVPSL02

Sliding Door Lock

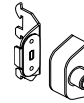

EVPSLLOCK

Sliding Privacy Door

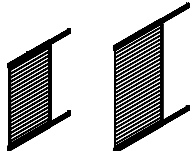

EVPSL66

EVPSL81

Mini Panel Kit

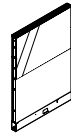

EVMPK02

Low Profile Foot

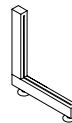

EVHLPF01



PRIVACY PANELS - PAGES 149-164

Glazed Monolithic Privacy Panel



EVPPXGTF4218

Ribbed Monolithic Privacy Panel



EVPPXGR4218

EVPPXGR4218M

EVPPXGRF4218

78" Glazed Monolithic Privacy Panel



EVPPXGT7824

EVPPXGT7824M

EVPPXGTF7824

Glazed Privacy Panel



EVPPGT5424

EVPPGT5424M

Glazed Privacy Panel

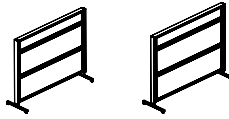

EVPPGT6624

EVPPGT6624M

Laminate Glazed Privacy Panel



EVPPHGTU5424

EVPPHGTU5424M

Laminate Glazed Privacy Panel

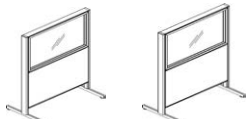

EVPPHGT5424

EVPPHGT6624M

Laminate Privacy Panel

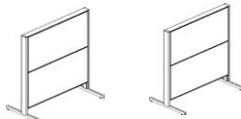

EVPPH2S5424

EVPPH2S5424M

Write Board Glazed Privacy Panel

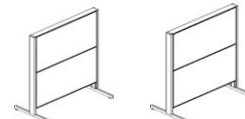

EVPPF2W5424

EVPPF2W5424M

Write Board Laminate Privacy Panel

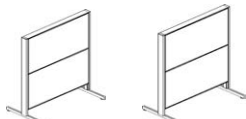

EVPPH2W5424

EVPPH2W5424M

This page provides an exploded view of a sample configuration highlighting each **Panel** component required when specifying this configuration.

Components

- | | |
|--|---|
| <p>A. EVPERA66 End-of-Run Kit (Wall mount)
Note: adds 1" to the width of a Panel Run.</p> <p>B. EVPFA6636 Segmented Panel</p> <p>C. EVPIC66 Inline Panel Connector</p> <p>D. EVPCPA266 Two-Way Corner Post
Note: Trim kit included.
Post Connectors can be custom manufactured with or without slots. Contact your Evolve Customer Support Representative for a special quote.</p> | <p>E. EVPVC66 Variable-Height Connector
Note: Connector height must reference taller Panel.</p> <p>F. EVPTVA24 Panel Trim Variable-Height</p> <p>G. EVPFA4236 Segmented Panel</p> |
|--|---|

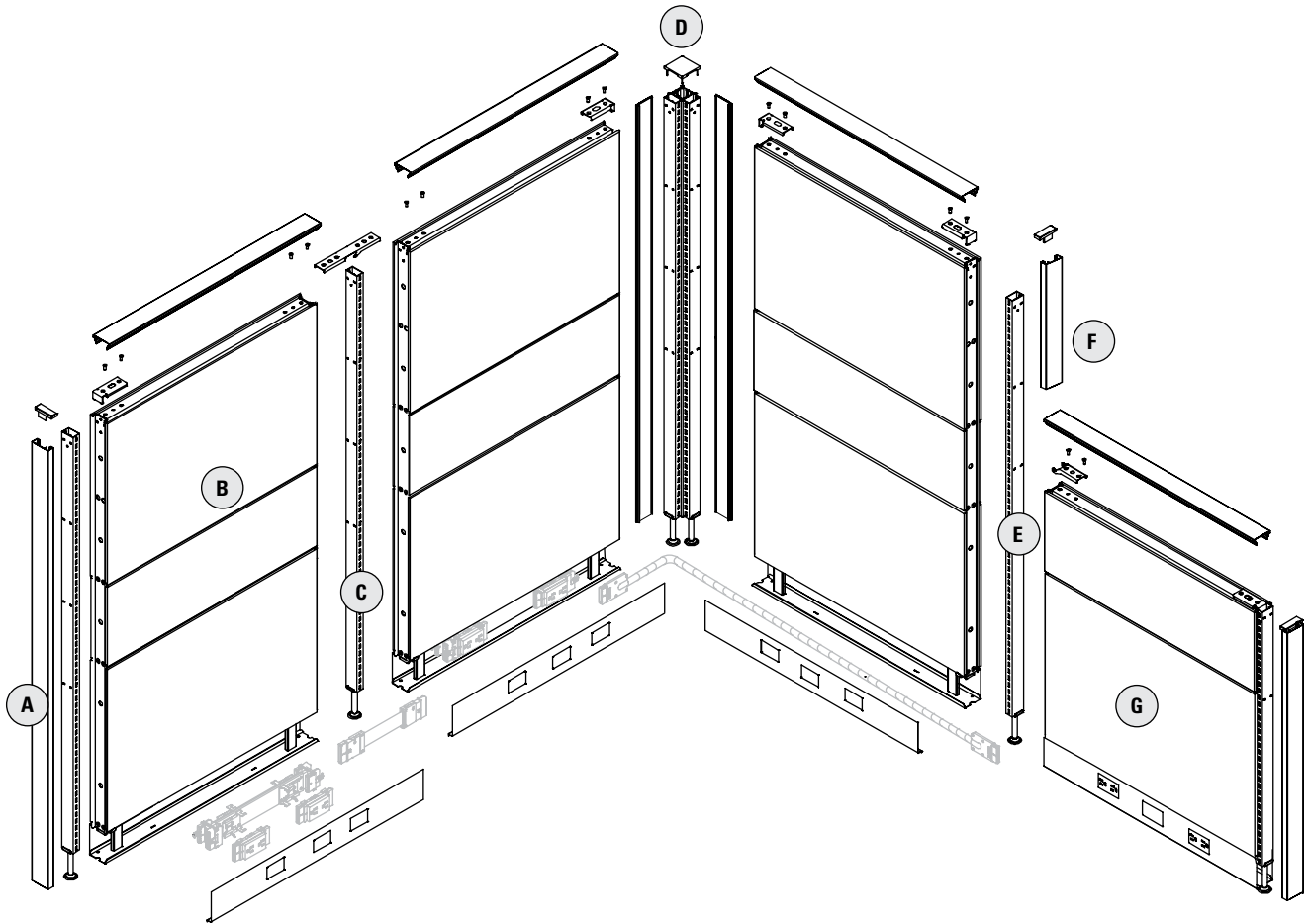

This page provides an exploded view of a sample configuration highlighting each **Beltline Power Panel** component required when specifying this configuration.

Components

- | | |
|---|---|
| <p>A. EVPERA66 End-of-Run Kit (Wall mount)
Note: adds 1" to the width of a Panel Run.</p> <p>B. EVPBCFAM6636 Monolithic Beltline Powered Chimney Panel</p> <p>C. EVPBIC66 Inline Panel Connector for Beltline Electric Panels</p> <p>D. EVPBIPA266 Two-Way Corner Post for Beltline Electric Panels
Note: Trim kit included.
Post Connectors can be custom manufactured with or without slots. Contact your Evolve Customer Support Representative for a special quote.
Note: All beltline post connectors come with PVC covers to install at beltline height on all sides.</p> | <p>E. EVPVC66 Variable-Height Connector for Beltline Electric Panels
Note: Connector height must reference taller Panel.</p> <p>F. EVPTEA24 Panel Extension Trim</p> <p>G. EVPBFAM4236 Monolithic Beltline Powered Panel</p> |
|---|---|

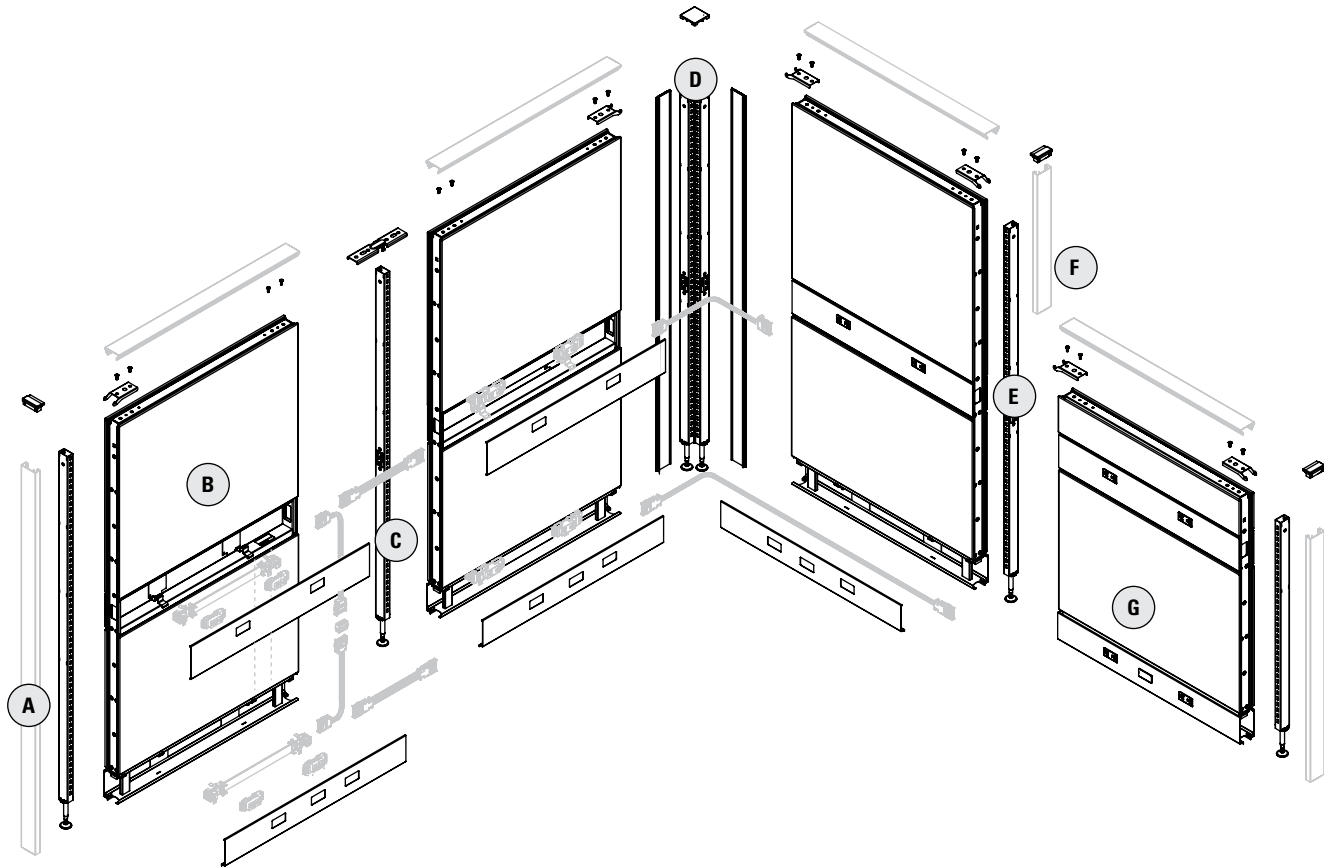

EACH ORDER MUST INCLUDE:

- Purchase Order
- Layout showing where the image(s) appear in the run of panels.
- A completed Price Chart, showing the location of the image(s) on each appropriate panel.
- Artwork must be submitted in accordance with the following artwork specifications.
- NOTE: Final artwork specification approval must be given before order can be processed.

TRANSFER DEVICES

- Email up to 10MB to your Evolve Customer Service Representative.
- Courier CD/DVD/USB drive to your Evolve Customer Service Representative.

ARTWORK SPECIFICATIONS

- Non-Photographic artwork should be vector art. Saved in Adobe Illustrator (.ai) or as an EPS (.eps)
- All bitmap or photographic artwork has to be at a minimum of 100 dpi at the full size of the panel to be printed.
- We accept Adobe CS5 files.
- Any linked files must be included or imbedded.
- Leave any PSD files un-flattened
- All fonts must be converted to outlines.
- Do not convert to CMYK, leave all images as RGB if possible
- No Word, Powerpoint, Publisher or other Microsoft files can be used.
- Include a PDF or .jpg for reference when sending native Photoshop or Illustrator format files.

COLOR MATCHING

- A Pantone color reference must be supplied or we cannot accept responsibility for correct color or color correction.
- When it is not possible to refer to Pantone colors, we will do our best to meet your requirements.

IMAGE CLARITY

- We will advise should the selected image not lend itself to the element size requested.

NOTE:

- We reserve the right to put an order on hold when the files are found to be incomplete or when documents have been either incorrectly saved, fonts have not been converted to curves or the job appears not to be commercially acceptable.

IMAGE BLEED:

- To facilitate placement on the panel. Extension of the image past the finished visible area of the panel (bleed) is required.
- Evolve Panels need a 3.5" bleed on all sides



EXAMPLE OF IMAGE RESOLUTION:

- The resolution required for a 36 wide x 24 high Evolve panel at 100dpi (minimum resolution)

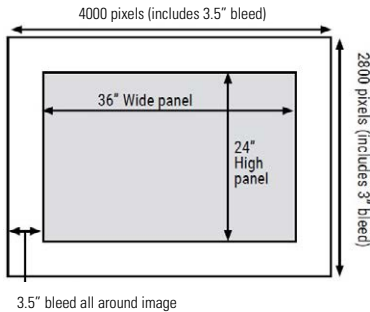

The resolution required for a 36 wide x 24 high Evolve panel at 300dpi (higher quality)

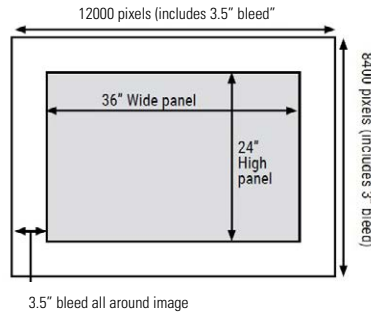

EVOLVE SYSTEMS - GRAPHIC PANEL EXAMPLE PROCEDURE

STEP 1: Customer orders the following EVPFA6636 panel with;

- Bottom module inside face (24/36 size fabric) with image 01.
- Middle module inside face (12/36 size fabric) with image 02.
- All other fabric material is regular fabric - top module inside face and all outside module faces.

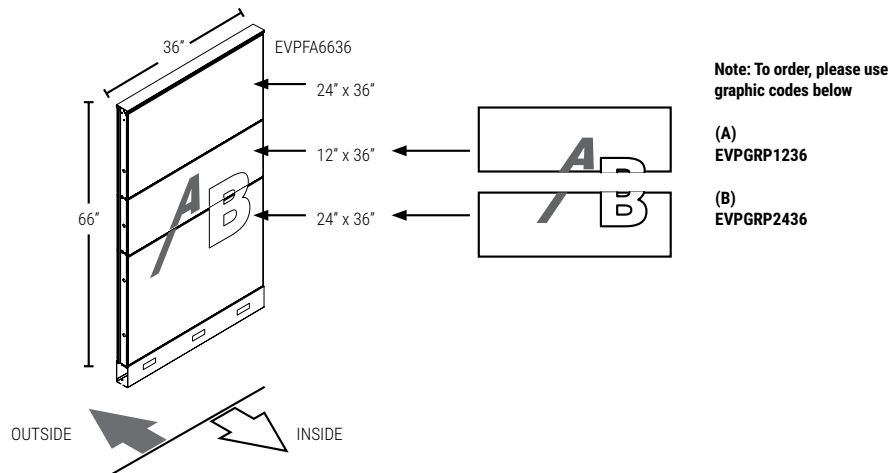

STEP 2: On the regular panel - replace fabric pieces with corresponding graphic pieces.

STEP 3: On the regular panel - replace fabric pieces with corresponding graphic pieces.

- EVPGRP1236 for the middle module inside face
- EVPGRP2436 for the bottom module inside face

EVGGRP - 6”H GRAPHIC FABRIC FACTORY INSTALLED

- Graphic fabric for one side of 6” module.
- Graphic fabric to be installed at factory at specified 6” H module of fabric panel
- Fabric panel not included. Prices shown are an upcharge to the applicable panel price. Please add the upcharge to the list price of the panel on which you are specifying a graphic.
- Applies to the following panels: EVPFA, EVFPF, EVPF1W, EVPF2W, EVPF1S, EVPF2S, EVPFGT, EVFPFGTU, EVPFOL, EVFPOL, EVPFO, EVFPFO, EVPFE, EVPFPE
- Note: initial set up charge is \$250 net per image

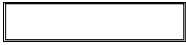
	DESCRIPTION	PRODUCT CODE	LIST PRICE	DIMENSIONS/INCHES		
				H	W	D
	Graphic fabric for 6” Module	EVGGRP0624	159	6	24	
		EVGGRP0630	200	6	30	
		EVGGRP0636	240	6	36	
		EVGGRP0642	279	6	42	
		EVGGRP0648	319	6	48	
		EVGGRP0654	362	6	54	
		EVGGRP0660	403	6	60	

EVGGRP - 12”H GRAPHIC FABRIC FACTORY INSTALLED

- Graphic fabric for one side of 12” module.
- Graphic fabric to be installed at factory at specified 12” H module of fabric panel
- Fabric panel not included. Prices shown are an upcharge to the applicable panel price. Please add the upcharge to the list price of the panel on which you are specifying a graphic.
- Applies to the following panels: EVPFA, EVFPF, EVPF1W, EVPF2W, EVPF1S, EVPF2S, EVPFGT, EVFPFGTU, EVPFOL, EVFPOL, EVPFO, EVFPFO, EVPFE, EVPFPE
- Note: initial set up charge is \$250 net per image

	DESCRIPTION	PRODUCT CODE	LIST PRICE	DIMENSIONS/INCHES		
				H	W	D
	Graphic fabric for 12” Module	EVGGRP1224	159	12	24	
		EVGGRP1230	200	12	30	
		EVGGRP1236	240	12	36	
		EVGGRP1242	279	12	42	
		EVGGRP1248	319	12	48	
		EVGGRP1254	362	12	54	
		EVGGRP1260	403	12	60	

EVGGRP - 18”H GRAPHIC FABRIC FACTORY INSTALLED

- Graphic fabric for one side of 18” module.
- Graphic fabric to be installed at factory at specified 18” H module of fabric panel
- Fabric panel not included. Prices shown are an upcharge to the applicable panel price. Please add the upcharge to the list price of the panel on which you are specifying a graphic.
- Applies to the following panels: EVPFA, EVFPF, EVPF1W, EVPF2W, EVPF1S, EVPF2S, EVPFGT, EVFPFGTU, EVPFOL, EVFPOL, EVPFO, EVFPFO, EVPFE, EVPFPE
- Note: initial set up charge is \$250 net per image

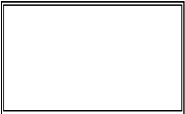
	DESCRIPTION	PRODUCT CODE	LIST PRICE	DIMENSIONS/INCHES		
				H	W	D
	Graphic fabric for 18” Module	EVGGRP1824	314	18	24	
		EVGGRP1830	394	18	30	
		EVGGRP1836	476	18	36	
		EVGGRP1842	558	18	42	
		EVGGRP1848	638	18	48	
		EVGGRP1854	718	18	54	
		EVGGRP1860	801	18	60	



EVPGRP - 24”H GRAPHIC FABRIC FACTORY INSTALLED

- Graphic fabric for one side of 24” module.
- Graphic fabric to be installed at factory at specified 24” H module of fabric panel
- Fabric panel not included. Prices shown are an upcharge to the applicable panel price. Please add the upcharge to the list price of the panel on which you are specifying a graphic.
- Applies to the following panels: EVPFA, EVFPF, EVPF1W, EVPF2W, EVPF1S, EVPF2S, EVPFGT, EVFPFGTU, EVPFOL, EVFPFOL, EVPFO, EVFPFO, EVPFE, EVFPFE
- Note: initial set up charge is \$250 net per image

DESCRIPTION	PRODUCT CODE	LIST PRICE	DIMENSIONS/INCHES		
			H	W	D
 Graphic fabric for 24” Module	EVPGRP2424	314	24	24	
	EVPGRP2430	394	24	30	
	EVPGRP2436	476	24	36	
	EVPGRP2442	558	24	42	
	EVPGRP2448	638	24	48	
	EVPGRP2454	718	24	54	
	EVPGRP2460	801	24	60	

EVPGRP - 36”H GRAPHIC FABRIC FACTORY INSTALLED

- Graphic fabric for one side of 36” module (42” panel)
- Graphic fabric to be installed at factory on monolithic module
- Fabric panel not included. Prices shown are an upcharge to the applicable panel price. Please add the upcharge to the list price of the panel on which you are specifying a graphic.
- Applies to the following panels: EVPFAM
- Note: initial set up charge is \$250 net per image

DESCRIPTION	PRODUCT CODE	LIST PRICE	DIMENSIONS/INCHES		
			H	W	D
 Graphic fabric for 36” Monolithic Module	EVPGRP3624	476	36	24	
	EVPGRP3630	613	36	30	
	EVPGRP3636	733	36	36	
	EVPGRP3642	854	36	42	
	EVPGRP3648	975	36	48	
	EVPGRP3654	1099	36	54	
	EVPGRP3660	1220	36	60	

EVPGRP - 42”H GRAPHIC FABRIC FACTORY INSTALLED

- Graphic fabric for one side of 42” module (48” panel)
- Graphic fabric to be installed at factory on monolithic module
- Fabric panel not included. Prices shown are an upcharge to the applicable panel price. Please add the upcharge to the list price of the panel on which you are specifying a graphic.
- Applies to the following panels: EVPFAM
- Note: initial set up charge is \$250 net per image

DESCRIPTION	PRODUCT CODE	LIST PRICE	DIMENSIONS/INCHES		
			H	W	D
 Graphic fabric for 42” Monolithic Module	EVPGRP4224	559	42	24	
	EVPGRP4230	712	42	30	
	EVPGRP4236	854	42	36	
	EVPGRP4242	997	42	42	
	EVPGRP4248	1141	42	48	
	EVPGRP4254	1281	42	54	
	EVPGRP4260	1424	42	60	

EVPGRP - 48”H GRAPHIC FABRIC FACTORY INSTALLED

- Graphic fabric for one side of 48” module (54” panel).
- Graphic fabric to be installed at factory on monolithic module
- Fabric panel not included. Prices shown are an upcharge to the applicable panel price. Please add the upcharge to the list price of the panel on which you are specifying a graphic.
- Applies to the following panels: EVPFAM
- Note: initial set up charge is \$250 net per image

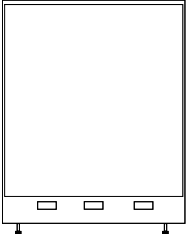
	DESCRIPTION	PRODUCT CODE	LIST PRICE	DIMENSIONS/INCHES		
				H	W	D
	Graphic fabric for 48” Monolithic Module	EVPGRP4824	636	48	24	
		EVPGRP4830	813	48	30	
		EVPGRP4836	975	48	36	
		EVPGRP4842	1141	48	42	
		EVPGRP4848	1302	48	48	
		EVPGRP4854	1466	48	54	
		EVPGRP4860	1627	48	60	

EVPGRP - 60”H GRAPHIC FABRIC FACTORY INSTALLED

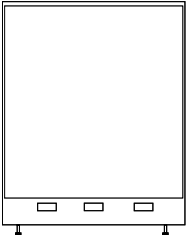

- Graphic fabric for one side of 60” module (66” panel).
- Graphic fabric to be installed at factory on monolithic module
- Fabric panel not included. Prices shown are an upcharge to the applicable panel price. Please add the upcharge to the list price of the panel on which you are specifying a graphic.
- Applies to the following panels: EVPFAM
- Note: initial set up charge is \$250 net per image

	DESCRIPTION	PRODUCT CODE	LIST PRICE	DIMENSIONS/INCHES		
				H	W	D
	Graphic fabric for 60” Monolithic Module	EVPGRP6024	801	60	24	
		EVPGRP6030	1018	60	30	
		EVPGRP6036	1220	60	36	
		EVPGRP6042	1424	60	42	
		EVPGRP6048	1627	60	48	
		EVPGRP6054	1829	60	54	
		EVPGRP6060	2033	60	60	





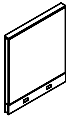

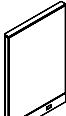
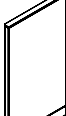
EVPFAM - MONOLITHIC PANEL

- Monolithic Panel incorporates fabric modules within a solid steel frame.
- Fabric covered modules are tackable and acoustical.
- Opposite sides of each panel may have a different fabric within the same grade at no upcharge.
- If different grades of fabric are used on one panel, the entire panel must be priced at highest grade.
- An aluminum low profile top cap is included.
- Stackability: Evolve panels can be increased in height in 6”H, 12”H, 18”H or 24”H increments. See Extension Module (pages 82-90) for part numbers.

	DESCRIPTION	PRODUCT CODE	LIST PRICE		DIMENSIONS/INCHES		
			Gr1	Gr2	H	W	D
	Monolithic Panel - 42" High	EVPFAM4218	363	398	42	18	2 7/8
		EVPFAM4224	389	428	42	24	2 7/8
		EVPFAM4230	445	495	42	30	2 7/8
		EVPFAM4236	475	532	42	36	2 7/8
		EVPFAM4242	525	593	42	42	2 7/8
		EVPFAM4248	572	648	42	48	2 7/8
		EVPFAM4254	629	711	42	54	2 7/8
	Monolithic Panel - 48" High	EVPFAM4818	368	403	48	18	2 7/8
		EVPFAM4824	405	449	48	24	2 7/8
		EVPFAM4830	469	519	48	30	2 7/8
		EVPFAM4836	511	568	48	36	2 7/8
		EVPFAM4842	570	636	48	42	2 7/8
		EVPFAM4848	618	692	48	48	2 7/8
		EVPFAM4854	684	769	48	54	2 7/8
	Monolithic Panel - 54" High	EVPFAM5418	373	408	54	18	2 7/8
		EVPFAM5424	411	454	54	24	2 7/8
		EVPFAM5430	477	527	54	30	2 7/8
		EVPFAM5436	531	590	54	36	2 7/8
		EVPFAM5442	592	658	54	42	2 7/8
		EVPFAM5448	644	719	54	48	2 7/8
		EVPFAM5454	706	792	54	54	2 7/8
	Monolithic Panel - 66" High	EVPFAM6618	460	496	66	18	2 7/8
		EVPFAM6624	504	548	66	24	2 7/8
		EVPFAM6630	570	623	66	30	2 7/8
		EVPFAM6636	664	722	66	36	2 7/8
		EVPFAM6642	743	811	66	42	2 7/8
		EVPFAM6648	806	879	66	48	2 7/8
		EVPFAM6654	896	978	66	54	2 7/8
EVPFAM6660	983	1073	66	60	2 7/8		

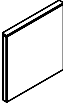
EVPLFAM - MONOLITHIC LIGHT PANEL

- Monolithic Light Panel incorporates fabric modules within a solid steel frame.
- There is no base raceway in Light Panels to accommodate electrical.
- Light Panel Connectors must be used in conjunction with Light Panels.
- Fabric covered modules are tackable and acoustical.
- Opposite sides of each panel may have a different fabric within the same grade at no upcharge.
- If different grades of fabric are used on one panel, the entire panel must be priced at highest grade.
- An aluminum low profile top cap is included.
- Stackability: Evolve Light panels can be increased in height in 6”H, 12”H, 18”H or 24”H increments. See Extension Module (pages 82-90) for part numbers.

	DESCRIPTION	PRODUCT CODE	LIST PRICE		DIMENSIONS/INCHES		
			Gr1	Gr2	H	W	D
	Monolithic Light Panel - 42” High	EVPLFAM4218	349	378	42	18	2 7/8
		EVPLFAM4224	367	407	42	24	2 7/8
		EVPLFAM4230	422	470	42	30	2 7/8
		EVPLFAM4236	451	504	42	36	2 7/8
		EVPLFAM4242	501	561	42	42	2 7/8
		EVPLFAM4248	543	613	42	48	2 7/8
		EVPLFAM4254	598	674	42	54	2 7/8
	Monolithic Light Panel - 48” High	EVPLFAM4818	354	383	48	18	2 7/8
		EVPLFAM4824	385	423	48	24	2 7/8
		EVPLFAM4830	445	493	48	30	2 7/8
		EVPLFAM4836	484	537	48	36	2 7/8
		EVPLFAM4842	541	602	48	42	2 7/8
		EVPLFAM4848	588	656	48	48	2 7/8
		EVPLFAM4854	649	726	48	54	2 7/8
	Monolithic Light Panel - 54” High	EVPLFAM5418	355	385	54	18	2 7/8
		EVPLFAM5424	391	425	54	24	2 7/8
		EVPLFAM5430	454	501	54	30	2 7/8
		EVPLFAM5436	504	558	54	36	2 7/8
		EVPLFAM5442	561	625	54	42	2 7/8
		EVPLFAM5448	611	679	54	48	2 7/8
		EVPLFAM5454	671	748	54	54	2 7/8
	Monolithic Light Panel - 66” High	EVPLFAM6618	440	470	66	18	2 7/8
		EVPLFAM6624	479	517	66	24	2 7/8
		EVPLFAM6630	541	591	66	30	2 7/8
		EVPLFAM6636	629	684	66	36	2 7/8
		EVPLFAM6642	706	768	66	42	2 7/8
		EVPLFAM6648	766	833	66	48	2 7/8
		EVPLFAM6654	849	926	66	54	2 7/8
EVPLFAM6660	932	1019	66	60	2 7/8		



EVPBFAM - MONOLITHIC BELTLINE POWERED PANEL

- Monolithic Beltline Powered Panel incorporates fabric modules with a power beltline raceway, within a solid steel frame.
- 6”H power beltline raceway, to accommodate electrical, is metal with knockouts on both side.
- A Chimney Panel is required to run electric and data from the base to belt.
- Beltline Connectors must be used in conjunction with beltline panels.
- Fabric covered modules are tackable and acoustical.
- Opposite sides of each panel may have a different fabric within the same grade at no upcharge.
- If different grades of fabric are used on one panel, the entire panel must be priced at highest grade.
- An aluminum low profile top cap is included.
- Stackability: Evolve panels can be increased in height in 6”H, 12”H, 18”H or 24”H increments. See Extension Module (pages 82-90) for part numbers.

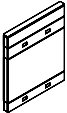
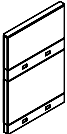
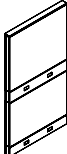
	DESCRIPTION	PRODUCT CODE	LIST PRICE		DIMENSIONS/INCHES		
			Gr1	Gr2	H	W	D
	Monolithic Beltline Powered Panel - 42” High 24” Fabric /6” Power Belt /6” Fabric	EVPBFAM4224	480	504	42	24	2 7/8
		EVPBFAM4230	567	597	42	30	2 7/8
		EVPBFAM4236	646	679	42	36	2 7/8
		EVPBFAM4242	728	768	42	42	2 7/8
		EVPBFAM4248	806	849	42	48	2 7/8
		EVPBFAM4254	882	931	42	54	2 7/8
		EVPBFAM4260	961	1017	42	60	2 7/8
	Monolithic Beltline Powered Panel - 54” High 24” Fabric /6” Power Belt /18” Fabric	EVPBFAM5424	576	611	54	24	2 7/8
		EVPBFAM5430	676	715	54	30	2 7/8
		EVPBFAM5436	764	809	54	36	2 7/8
		EVPBFAM5442	857	910	54	42	2 7/8
		EVPBFAM5448	941	1006	54	48	2 7/8
		EVPBFAM5454	1033	1103	54	54	2 7/8
		EVPBFAM5460	1120	1194	54	60	2 7/8
	Monolithic Beltline Powered Panel - 66” High 24” Fabric /6” Power Belt /30” Fabric	EVPBFAM6624	682	744	66	24	2 7/8
		EVPBFAM6630	796	867	66	30	2 7/8
		EVPBFAM6636	900	982	66	36	2 7/8
		EVPBFAM6642	1014	1110	66	42	2 7/8
		EVPBFAM6648	1119	1227	66	48	2 7/8
		EVPBFAM6654	1227	1347	66	54	2 7/8
		EVPBFAM6660	1335	1468	66	60	2 7/8

EVPBLFAM - MONOLITHIC BELTLINE POWERED LIGHT PANEL

- Monolithic Beltline Powered Light Panel incorporates fabric modules with a power beltline raceway within a solid steel frame
- 6”H power beltline raceway, to accommodate electrical, is metal with knockouts on both sides.
- There is no base raceway in Light Panels to accommodate electrical
- Light Beltline Panel Connectors must be used in conjunction with Light Beltline Panels.
- Fabric covered modules are tackable and acoustical.
- Opposite sides of each panel may have a different fabric within the same grade at no upcharge.
- If different grades of fabric are used on one panel, the entire panel must be priced at highest grade.
- An aluminum low profile top cap is included.
- Stackability: Evolve Light panels can be increased in height in 6”H, 12”H, 18”H or 24”H increments. See Extension Module (pages 82-90) for part numbers.

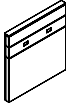
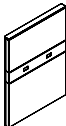
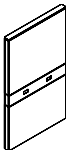
	DESCRIPTION	PRODUCT CODE	LIST PRICE		DIMENSIONS/INCHES		
			Gr1	Gr2	H	W	D
	Monolithic Beltline Powered Light Panel - 42” High	EVPBLFAM4224	456	480	42	24	2 7/8
		EVPBLFAM4230	539	567	42	30	2 7/8
	24” Fabric /6” Power Belt /6” Fabric	EVPBLFAM4236	613	648	42	36	2 7/8
		EVPBLFAM4242	690	730	42	42	2 7/8
		EVPBLFAM4248	766	808	42	48	2 7/8
		EVPBLFAM4254	839	888	42	54	2 7/8
		EVPBLFAM4260	912	968	42	60	2 7/8
	Monolithic Beltline Powered Light Panel - 54” High	EVPBLFAM5424	531	564	54	24	2 7/8
		EVPBLFAM5430	622	664	54	30	2 7/8
	24” Fabric /6” Power Belt /18” Fabric	EVPBLFAM5436	702	747	54	36	2 7/8
		EVPBLFAM5442	785	840	54	42	2 7/8
		EVPBLFAM5448	867	929	54	48	2 7/8
		EVPBLFAM5454	952	1020	54	54	2 7/8
		EVPBLFAM5460	1029	1105	54	60	2 7/8
	Monolithic Beltline Powered Light Panel - 66” High	EVPBLFAM6624	634	696	66	24	2 7/8
		EVPBLFAM6630	737	810	66	30	2 7/8
	24” Fabric /6” Power Belt /30” Fabric	EVPBLFAM6636	835	920	66	36	2 7/8
		EVPBLFAM6642	941	1038	66	42	2 7/8
		EVPBLFAM6648	1040	1151	66	48	2 7/8
		EVPBLFAM6654	1141	1260	66	54	2 7/8
		EVPBLFAM6660	1241	1374	66	60	2 7/8



EVPBCFAM - MONOLITHIC BELTLINE POWERED CHIMNEY PANEL

- Monolithic Chimney Beltline Powered Panel incorporates fabric modules with a power beltline raceway within a solid steel frame.
- A Chimney Panel is required to run electric and data from the base to belt.
- Separate electric harness required to go from base to belt (see EVE8CPCP).
- 6”H power beltline raceway, to accommodate electrical, is metal with knockouts on both sides.
- Beltline Connectors must be used in conjunction with beltline panels.
- Fabric covered modules are tackable and acoustical.
- Opposite sides of each panel may have a different fabric within the same grade at no upcharge.
- If different grades of fabric are used on one panel, the entire panel must be priced at highest grade.
- An aluminum low profile top cap is included.
- Stackability: Evolve panels can be increased in height in 6”H, 12”H, 18”H or 24”H increments. See Extension Module listings for part numbers

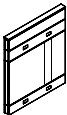
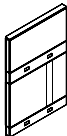
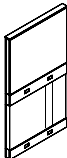
	DESCRIPTION	PRODUCT CODE	LIST PRICE		DIMENSIONS/INCHES		
			Gr1	Gr2	H	W	D
	Monolithic Beltline Powered Chimney Panel - 42” High 24” Fabric Chimney /6” Power Belt /6” Fabric	EVPBCFAM4236	726	764	42	36	2 7/8
		EVPBCFAM4242	808	847	42	42	2 7/8
	Monolithic Beltline Powered Chimney Panel - 54” High 24” Fabric Chimney /6” Power Belt /18” Fabric	EVPBCFAM5436	840	888	54	36	2 7/8
		EVPBCFAM5442	935	988	54	42	2 7/8
	Monolithic Beltline Powered Chimney Panel - 66” High 24” Fabric Chimney /6” Power Belt /30” Fabric	EVPBCFAM6636	978	1062	66	36	2 7/8
		EVPBCFAM6642	1093	1190	66	42	2 7/8

EVE8CPCP - CHIMNEY PANEL JUMPER CABLE KIT

- Contains two (2) 17” flexible harnesses and one (1) “I” connector.
- Used to connect electric from the base to the beltline raceway in Beltline Powered Chimney panel.
- Must use in conjunction with base power distribution harness and beltline power distribution harness (sold separately)

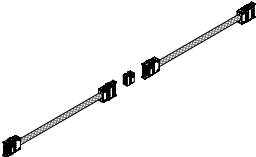
	DESCRIPTION	PRODUCT CODE	LIST PRICE	DIMENSIONS/INCHES		
				H	W	D
	Chimney Panel Jumper Cable Kit	EVE8CPCP	341			

EVPBFFAM - MONOLITHIC BELTLINE NON-POWERED PANEL

- Monolithic Beltline Non-Powered Panel incorporates fabric modules within a solid steel frame.
- Electrical cannot pass through panel at the beltline level.
- Fabric covered modules are tackable and acoustical.
- Opposite sides of each panel may have a different fabric within the same grade at no upcharge.
- If different grades of fabric are used on one panel, the entire panel must be priced at highest grade.
- An aluminum low profile top cap is included.
- Stackability: Evolve panels can be increased in height in 6”H, 12”H, 18”H or 24”H increments. See Extension Module (pages 82-90) for part numbers.

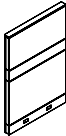
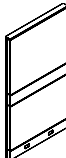
	DESCRIPTION	PRODUCT CODE	LIST PRICE		DIMENSIONS/INCHES		
			Gr1	Gr2	H	W	D
	Monolithic Beltline Non-Powered Panel - 54” High	EVPBFFAM5424	576	615	54	24	2 7/8
	24” Fabric /6” Fabric /18” Fabric	EVPBFFAM5430	676	721	54	30	2 7/8
		EVPBFFAM5436	764	814	54	36	2 7/8
		EVPBFFAM5442	857	919	54	42	2 7/8
		EVPBFFAM5448	941	1014	54	48	2 7/8
		EVPBFFAM5454	1033	1113	54	54	2 7/8
		EVPBFFAM5460	1120	1209	54	60	2 7/8
	Monolithic Beltline Non-Powered Panel - 66” High	EVPBFFAM6624	682	746	66	24	2 7/8
	24” Fabric /6” Fabric /30” Fabric	EVPBFFAM6630	796	871	66	30	2 7/8
		EVPBFFAM6636	900	987	66	36	2 7/8
		EVPBFFAM6642	1014	1118	66	42	2 7/8
		EVPBFFAM6648	1119	1235	66	48	2 7/8
		EVPBFFAM6654	1227	1356	66	54	2 7/8
		EVPBFFAM6660	1335	1479	66	60	2 7/8

EVPBLFFAM - MONOLITHIC BELTLINE NON-POWERED LIGHT PANEL

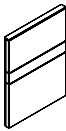
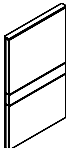

- Monolithic Beltline Non-Powered Light Panel incorporates all fabric modules within a solid steel frame.
- There is no base raceway in Light Panels to accommodate electrical.
- Electrical cannot pass through panel at the beltline level.
- Fabric covered modules are tackable and acoustical.
- Opposite sides of each panel may have a different fabric within the same grade at no upcharge.
- If different grades of fabric are used on one panel, the entire panel must be priced at highest grade.
- An aluminum low profile top cap is included.
- Stackability: Evolve panels can be increased in height in 6”H, 12”H, 18”H or 24”H increments. See Extension Module (pages 82-90) for part numbers.

	DESCRIPTION	PRODUCT CODE	LIST PRICE		DIMENSIONS/INCHES		
			Gr1	Gr2	H	W	D
	Monolithic Beltline Non-Powered Light Panel - 54” High	EVPBLFFAM5424	531	570	54	24	2 7/8
	24” Fabric /6” Fabric /18” Fabric	EVPBLFFAM5430	625	673	54	30	2 7/8
		EVPBLFFAM5436	702	753	54	36	2 7/8
		EVPBLFFAM5442	785	849	54	42	2 7/8
		EVPBLFFAM5448	867	938	54	48	2 7/8
		EVPBLFFAM5454	952	1029	54	54	2 7/8
		EVPBLFFAM5460	1029	1118	54	60	2 7/8
	Monolithic Beltline Non-Powered Light Panel - 66” High	EVPBLFFAM6624	634	699	66	24	2 7/8
	24” Fabric /6” Fabric /30” Fabric	EVPBLFFAM6630	737	814	66	30	2 7/8
		EVPBLFFAM6636	835	926	66	36	2 7/8
		EVPBLFFAM6642	941	1048	66	42	2 7/8
		EVPBLFFAM6648	1040	1158	66	48	2 7/8
		EVPBLFFAM6654	1141	1270	66	54	2 7/8
		EVPBLFFAM6660	1241	1384	66	60	2 7/8

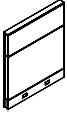
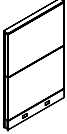
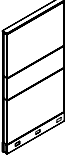

EVPFA - SEGMENTED PANEL

- Segmented Panel incorporates fabric modules within a solid steel frame.
- Fabric covered modules are tackable and acoustical.
- Opposite sides of each panel may have a different fabric within the same grade at no upcharge.
- If different grades of fabric are used on one panel, the entire panel must be priced at highest grade.
- An aluminum low profile top cap is included.
- Stackability: Evolve panels can be increased in height in 6”H, 12”H, 18”H or 24”H increments. See Extension Module (pages 82-90) for part numbers.

	DESCRIPTION	PRODUCT CODE	LIST PRICE		DIMENSIONS/INCHES		
			Gr1	Gr2	H	W	D
	Segmented Panel - 30" High	EVPPFA3018	355	370	30	18	2 7/8
		EVPPFA3024	367	392	30	24	2 7/8
		EVPPFA3030	411	435	30	30	2 7/8
		EVPPFA3036	444	471	30	36	2 7/8
		EVPPFA3042	475	508	30	42	2 7/8
		EVPPFA3048	524	560	30	48	2 7/8
		EVPPFA3054	566	607	30	54	2 7/8
		EVPPFA3060	607	654	30	60	2 7/8
	Segmented Panel - 42" High	EVPPFA4218	392	417	42	18	2 7/8
		EVPPFA4224	415	446	42	24	2 7/8
		EVPPFA4230	481	517	42	30	2 7/8
		EVPPFA4236	515	559	42	36	2 7/8
		EVPPFA4242	591	638	42	42	2 7/8
		EVPPFA4248	634	689	42	48	2 7/8
		EVPPFA4254	703	765	42	54	2 7/8
		EVPPFA4260	770	836	42	60	2 7/8
	Segmented Panel - 54" High	EVPPFA5418	421	454	54	18	2 7/8
		EVPPFA5424	459	500	54	24	2 7/8
		EVPPFA5430	525	574	54	30	2 7/8
		EVPPFA5436	587	644	54	36	2 7/8
		EVPPFA5442	664	728	54	42	2 7/8
		EVPPFA5448	736	810	54	48	2 7/8
		EVPPFA5454	799	876	54	54	2 7/8
		EVPPFA5460	858	943	54	60	2 7/8
	Segmented Panel - 66" High	EVPPFA6618	531	570	66	18	2 7/8
		EVPPFA6624	570	621	66	24	2 7/8
		EVPPFA6630	632	690	66	30	2 7/8
		EVPPFA6636	739	812	66	36	2 7/8
		EVPPFA6642	833	914	66	42	2 7/8
		EVPPFA6648	896	986	66	48	2 7/8
		EVPPFA6654	971	1070	66	54	2 7/8
		EVPPFA6660	1052	1161	66	60	2 7/8
	Segmented Panel - 66" High	EVPPFA6618S	531	570	66	18	2 7/8
		EVPPFA6624S	570	621	66	24	2 7/8
		EVPPFA6630S	632	690	66	30	2 7/8
		EVPPFA6636S	739	812	66	36	2 7/8
		EVPPFA6642S	833	914	66	42	2 7/8
		EVPPFA6648S	896	986	66	48	2 7/8
		EVPPFA6654S	971	1070	66	54	2 7/8
		EVPPFA6660S	1052	1161	66	60	2 7/8

EVPLFA - SEGMENTED LIGHT PANEL

- Segmented Light Panel incorporates fabric modules within a solid steel frame.
- There is no base raceway in Light Panels to accommodate electrical.
- Light Panel Connectors must be used in conjunction with Light Panels.
- Fabric covered modules are tackable and acoustical.
- Opposite sides of each panel may have a different fabric within the same grade at no upcharge.
- If different grades of fabric are used on one panel, the entire panel must be priced at highest grade.
- An aluminum low profile top cap is included.
- Stackability: Evolve Light panels can be increased in height in 6”H, 12”H, 18”H or 24”H increments. See Extension Module (pages 82-90) for part numbers.

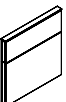
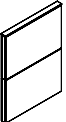
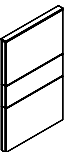
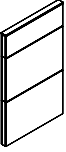
	DESCRIPTION	PRODUCT CODE	LIST PRICE		DIMENSIONS/INCHES		
			Gr1	Gr2	H	W	D
	Segmented Light Panel - 30" High	EVPLFA3018	337	352	30	18	2 7/8
		EVPLFA3024	352	367	30	24	2 7/8
		EVPLFA3030	391	412	30	30	2 7/8
		EVPLFA3036	421	445	30	36	2 7/8
		EVPLFA3042	451	480	30	42	2 7/8
		EVPLFA3048	499	533	30	48	2 7/8
		EVPLFA3054	537	574	30	54	2 7/8
	Segmented Light Panel - 42" High	EVPLFA4218	371	393	42	18	2 7/8
		EVPLFA4224	394	421	42	24	2 7/8
		EVPLFA4230	457	493	42	30	2 7/8
		EVPLFA4236	493	531	42	36	2 7/8
		EVPLFA4242	560	602	42	42	2 7/8
		EVPLFA4248	602	655	42	48	2 7/8
		EVPLFA4254	667	721	42	54	2 7/8
	Segmented Light Panel - 54" High	EVPLFA5418	400	429	54	18	2 7/8
		EVPLFA5424	439	472	54	24	2 7/8
		EVPLFA5430	501	543	54	30	2 7/8
		EVPLFA5436	557	607	54	36	2 7/8
		EVPLFA5442	629	687	54	42	2 7/8
		EVPLFA5448	702	768	54	48	2 7/8
		EVPLFA5454	761	831	54	54	2 7/8
	Segmented Light Panel - 66" High	EVPLFA6618	504	539	66	18	2 7/8
		EVPLFA6624	539	588	66	24	2 7/8
		EVPLFA6630	600	655	66	30	2 7/8
		EVPLFA6636	704	769	66	36	2 7/8
		EVPLFA6642	794	866	66	42	2 7/8
		EVPLFA6648	849	931	66	48	2 7/8
		EVPLFA6654	922	1017	66	54	2 7/8
	Segmented Light Panel - 66" High	EVPLFA6618S	504	539	66	18	2 7/8
		EVPLFA6624S	539	588	66	24	2 7/8
		EVPLFA6630S	600	655	66	30	2 7/8
		EVPLFA6636S	704	769	66	36	2 7/8
		EVPLFA6642S	794	866	66	42	2 7/8
		EVPLFA6648S	849	931	66	48	2 7/8
		EVPLFA6654S	922	1017	66	54	2 7/8
EVPLFA6660S	1000	1102	66	60	2 7/8		



EVFPF - SEGMENTED PREMIUM PANEL

- Segmented Premium Panel incorporates fabric modules within a solid steel frame.
- Segmented Premium panels incorporate 12" H acoustic modules above 24" base module , plus 6" H base raceway.
- Fabric covered modules are tackable and acoustical.
- Opposite sides of each panel may have a different fabric within the same grade at no upcharge.
- If different grades of fabric are used on one panel, the entire panel must be priced at highest grade.
- An aluminum low profile top cap is included.
- Stackability: Evolve panels can be increased in height in 6"H, 12"H, 18"H or 24"H increments. See Extension Module (pages 82-90) for part numbers.

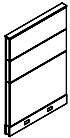
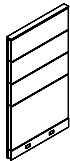
	DESCRIPTION	PRODUCT CODE	LIST PRICE		DIMENSIONS/INCHES		
			Gr1	Gr2	H	W	D
	Segmented Premium Panel - 54" High	EVFPF5418	494	525	54	18	2 7/8
		EVFPF5424	524	563	54	24	2 7/8
		EVFPF5430	577	625	54	30	2 7/8
		EVFPF5436	679	734	54	36	2 7/8
		EVFPF5442	768	832	54	42	2 7/8
		EVFPF5448	821	891	54	48	2 7/8
		EVFPF5454	871	955	54	54	2 7/8
		EVFPF5460	921	1009	54	60	2 7/8
	Segmented Premium Panel - 66" High	EVFPF6618	621	659	66	18	2 7/8
		EVFPF6624	646	695	66	24	2 7/8
		EVFPF6630	703	765	66	30	2 7/8
		EVFPF6636	744	817	66	36	2 7/8
		EVFPF6642	886	967	66	42	2 7/8
		EVFPF6648	970	1061	66	48	2 7/8
		EVFPF6654	1033	1130	66	54	2 7/8
		EVFPF6660	1098	1208	66	60	2 7/8

EVPLFP - SEGMENTED LIGHT PANEL - PREMIUM

- Segmented Premium Light Panel incorporates fabric modules within a solid steel frame.
- Segmented Premium panels incorporate 12" H acoustic modules above 24" base module , plus 6" H open base.
- There is no base raceway in Light Panels to accommodate electrical.
- Light Panel Connectors must be used in conjunction with Light Panels.
- Fabric covered modules are tackable and acoustical.
- Opposite sides of each panel may have a different fabric within the same grade at no upcharge.
- If different grades of fabric are used on one panel, the entire panel must be priced at highest grade.
- An aluminum low profile top cap is included.
- Stackability: Evolve Light panels can be increased in height in 6"H, 12"H, 18"H or 24"H increments. See Extension Module (pages 82-90) for part numbers.

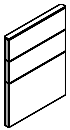
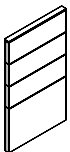
	DESCRIPTION	PRODUCT CODE	LIST PRICE		DIMENSIONS/INCHES		
			Gr1	Gr2	H	W	D
	Segmented Premium Light Panel - Premium - 54" High	EVPLFP5418	470	499	54	18	2 7/8
		EVPLFP5424	499	535	54	24	2 7/8
		EVPLFP5430	548	593	54	30	2 7/8
		EVPLFP5436	647	697	54	36	2 7/8
		EVPLFP5442	730	788	54	42	2 7/8
		EVPLFP5448	779	845	54	48	2 7/8
		EVPLFP5454	829	902	54	54	2 7/8
		EVPLFP5460	874	959	54	60	2 7/8
	Segmented Premium Light Panel - Premium - 66" High	EVPLFP6618	591	625	66	18	2 7/8
		EVPLFP6624	613	657	66	24	2 7/8
		EVPLFP6630	667	721	66	30	2 7/8
		EVPLFP6636	707	774	66	36	2 7/8
		EVPLFP6642	840	918	66	42	2 7/8
		EVPLFP6648	921	1006	66	48	2 7/8
		EVPLFP6654	982	1073	66	54	2 7/8
		EVPLFP6660	1042	1146	66	60	2 1/4

EVPBFA - SEGMENTED BELTLINE POWERED PANEL

- Segmented Beltline Powered Panel incorporates fabric modules with a power beltline raceway, within a solid steel frame.
- A Chimney Panel is required to run electric and data from the base to belt.
- 6”H power beltline raceway, to accommodate electrical, is metal with knockouts on both sides.
- Beltline connectors must be used in conjunction with beltline panels.
- Fabric covered modules are tackable and acoustical.
- Opposite sides of each panel may have a different fabric within the same grade at no upcharge.
- If different grades of fabric are used on one panel, the entire panel must be priced at highest grade.
- An aluminum low profile top cap is included.
- Stackability: Evolve panels can be increased in height in 6”H, 12”H, 18”H or 24”H increments. See Extension Module (pages 82-90) for part numbers.

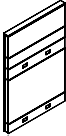
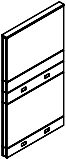
	DESCRIPTION	PRODUCT CODE	LIST PRICE		DIMENSIONS/INCHES		
			Gr1	Gr2	H	W	D
	Segmented Beltline Powered Panel - 54” High 24” Fabric /6” Power /6” Fabric /12” Fabric	EVPBFA5424	575	608	54	24	2 7/8
		EVPBFA5430	674	713	54	30	2 7/8
		EVPBFA5436	775	824	54	36	2 7/8
		EVPBFA5442	869	923	54	42	2 7/8
		EVPBFA5448	951	1014	54	48	2 7/8
		EVPBFA5454	1042	1113	54	54	2 7/8
		EVPBFA5460	1136	1213	54	60	2 7/8
	Segmented Beltline Powered Panel - 66” High 24” Fabric /6” Power /6” Fabric /24” Fabric	EVPBFA6624	687	733	66	24	2 7/8
		EVPBFA6630	806	857	66	30	2 7/8
		EVPBFA6636	912	976	66	36	2 7/8
		EVPBFA6642	1027	1098	66	42	2 7/8
		EVPBFA6648	1135	1214	66	48	2 7/8
		EVPBFA6654	1246	1334	66	54	2 7/8
		EVPBFA6660	1355	1450	66	60	2 7/8

EVPBLFA - SEGMENTED BELTLINE POWERED LIGHT PANEL

- Segmented Beltline Powered Light Panel incorporates fabric modules with a power beltline raceway, within a solid steel frame.
- There is no base raceway in Light Panels to accommodate electrical.
- 6”H power beltline raceway, to accommodate electrical, is metal with knockouts on both sides.
- Beltline Light Panel Connectors must be used in conjunction with Beltline Light Panels.
- Fabric covered modules are tackable and acoustical.
- Opposite sides of each panel may have a different fabric within the same grade at no upcharge.
- If different grades of fabric are used on one panel, the entire panel must be priced at highest grade.
- An aluminum low profile top cap is included.
- Stackability: Evolve Light panels can be increased in height in 6”H, 12”H, 18”H or 24”H increments. See Extension Module (pages 82-90) for part numbers.

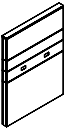
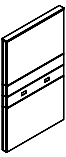
	DESCRIPTION	PRODUCT CODE	LIST PRICE		DIMENSIONS/INCHES		
			Gr1	Gr2	H	W	D
	Segmented Beltline Powered Light Panel - 54” High 24” Fabric /6” Power /6” Fabric /12” Fabric	EVPBLFA5424	528	561	54	24	2 7/8
		EVPBLFA5430	618	657	54	30	2 7/8
		EVPBLFA5436	714	765	54	36	2 7/8
		EVPBLFA5442	801	857	54	42	2 7/8
		EVPBLFA5448	874	938	54	48	2 7/8
		EVPBLFA5454	960	1028	54	54	2 7/8
		EVPBLFA5460	1048	1121	54	60	2 7/8
	Segmented Beltline Powered Light Panel - 66” High 24” Fabric /6” Power /6” Fabric /24 Fabric	EVPBLFA6624	634	677	66	24	2 7/8
		EVPBLFA6630	739	794	66	30	2 7/8
		EVPBLFA6636	840	905	66	36	2 7/8
		EVPBLFA6642	946	1017	66	42	2 7/8
		EVPBLFA6648	1042	1121	66	48	2 7/8
		EVPBLFA6654	1146	1234	66	54	2 7/8
		EVPBLFA6660	1247	1345	66	60	2 7/8



EVPBCFA - SEGMENTED BELTLINE POWERED CHIMNEY PANEL

- Segmented Chimney Beltline Powered Panel incorporates fabric modules with a power beltline raceway, within a solid steel frame.
- A Chimney Panel is required to run electric and data from the base to belt.
- Separate electric harness required to go from base to belt (see EVE8CPCP).
- 6”H power beltline raceway, to accommodate electrical, is metal with knockouts on both sides.
- Beltline Connectors must be used in conjunction with beltline panels.
- Fabric covered modules are tackable and acoustical.
- Opposite sides of each panel may have a different fabric within the same grade at no upcharge.
- If different grades of fabric are used on one panel, the entire panel must be priced at highest grade.
- An aluminum low profile top cap is included.
- Stackability: Evolve panels can be increased in height in 6”H, 12”H, 18”H or 24”H increments. See Extension Module (pages 82-90) for part numbers.

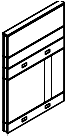
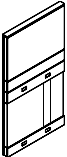
	DESCRIPTION	PRODUCT CODE	LIST PRICE		DIMENSIONS/INCHES		
			Gr1	Gr2	H	W	D
	Segmented Beltline Powered Chimney Panel - 54” High	EVPBCFA5436	857	905	54	36	2 7/8
	24” Fabric Chimney /6” Power / 6” Fabric /12” Fabric	EVPBCFA5442	951	1006	54	42	2 7/8
	Segmented Beltline Powered Chimney Panel - 66” High	EVPBCFA6636	992	1058	66	36	2 7/8
	24” Fabric Chimney /6” Power / 6” Fabric /24” Fabric	EVPBCFA6642	1107	1179	66	42	2 7/8

EVE8CPCP - CHIMNEY PANEL JUMPER CABLE KIT

- Contains two (2) 17” flexible harnesses and one (1) “I” connector.
- Used to connect electric from the base to the beltline raceway in Beltline Powered Chimney panel.
- Must use in conjunction with base power distribution harness and beltline power distribution harness (sold separately)

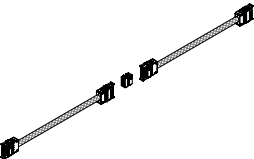
	DESCRIPTION	PRODUCT CODE	LIST PRICE	DIMENSIONS/INCHES		
				H	W	D
	Chimney Panel Jumper Cable Kit	EVE8CPCP	341			

EVPBFFA - SEGMENTED BELTLINE NON-POWERED PANEL

- Double Beltline Non-Powered Panel incorporates all fabric modules within a solid steel frame.
- Electrical cannot pass through panel at the beltline level.
- Fabric covered modules are tackable and acoustical.
- Opposite sides of each panel may have a different fabric within the same grade at no upcharge.
- If different grades of fabric are used on one panel, the entire panel must be priced at highest grade.
- An aluminum low profile top cap is included.
- Stackability: Evolve panels can be increased in height in 6”H, 12”H, 18”H or 24”H increments. See Extension Module (pages 82-90) for part numbers.

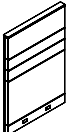
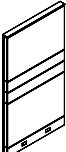
	DESCRIPTION	PRODUCT CODE	LIST PRICE		DIMENSIONS/INCHES		
			Gr1	Gr2	H	W	D
	Segmented Beltline Non-Powered Panel - 54” High	EVPBFFA5424	555	587	54	24	2 7/8
		EVPBFFA5430	607	653	54	30	2 7/8
	24” Fabric /6” Fabric /6” Fabric /12” Fabric	EVPBFFA5436	714	769	54	36	2 7/8
		EVPBFFA5442	806	867	54	42	2 7/8
		EVPBFFA5448	864	931	54	48	2 7/8
		EVPBFFA5454	911	988	54	54	2 7/8
		EVPBFFA5460	956	1041	54	60	2 7/8
	Segmented Beltline Non-Powered Panel - 66” High	EVPBFFA6624	601	648	66	24	2 7/8
		EVPBFFA6630	706	765	66	30	2 7/8
	24” Fabric /6” Fabric /6” Fabric /24” Fabric	EVPBFFA6636	814	882	66	36	2 7/8
		EVPBFFA6642	916	992	66	42	2 7/8
		EVPBFFA6648	1001	1088	66	48	2 7/8
		EVPBFFA6654	1100	1195	66	54	2 7/8
		EVPBFFA6660	1196	1307	66	60	2 7/8

EVPBLFFA - SEGMENTED BELTLINE NON-POWERED LIGHT PANEL

- Double Beltline Non-Powered Panel incorporates all fabric modules within a solid steel frame.
- Electrical cannot pass through panel at the beltline level.
- There is no base raceway in Light Panels to accommodate electrical
- Fabric covered modules are tackable and acoustical.
- Opposite sides of each panel may have a different fabric within the same grade at no upcharge.
- If different grades of fabric are used on one panel, the entire panel must be priced at highest grade.
- An aluminum low profile top cap is included.
- Stackability: Evolve panels can be increased in height in 6”H, 12”H, 18”H or 24”H increments.
- See Extension Module (pages 82-90) for part numbers.

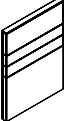
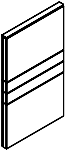
	DESCRIPTION	PRODUCT CODE	LIST PRICE		DIMENSIONS/INCHES		
			Gr1	Gr2	H	W	D
	Segmented Beltline Non-Powered Light Panel - 54” High	EVPBLFFA5424	457	497	54	24	2 7/8
		EVPBLFFA5430	539	583	54	30	2 7/8
	24” Fabric /6” Fabric /6” Fabric /12” Fabric	EVPBLFFA5436	612	667	54	36	2 7/8
		EVPBLFFA5442	685	747	54	42	2 7/8
		EVPBLFFA5448	761	829	54	48	2 7/8
		EVPBLFFA5454	866	942	54	54	2 7/8
		EVPBLFFA5460	908	992	54	60	2 7/8
	Segmented Beltline Non-Powered Light Panel - 66” High	EVPBLFFA6624	570	616	66	24	2 7/8
		EVPBLFFA6630	632	687	66	30	2 7/8
	24” Fabric /6” Fabric /6” Fabric /24” Fabric	EVPBLFFA6636	739	808	66	36	2 7/8
		EVPBLFFA6642	833	911	66	42	2 7/8
		EVPBLFFA6648	896	982	66	48	2 7/8
		EVPBLFFA6654	971	1069	66	54	2 7/8
		EVPBLFFA6660	1052	1159	66	60	2 7/8



EVPMGU - MONOLITHIC 12”H GLAZED PANEL - TEMPERED GLASS

- Monolithic 12”H Glazed Panel incorporates a lower fabric module with a 12”H top position glazed module, into a solid steel frame.
- Fabric covered modules are tackable and acoustical.
- Opposite sides of each panel may have a different fabric within the same grade at no upcharge.
- If different grades of fabric are used on one panel, the entire panel must be priced at highest grade.
- An aluminum low profile top cap is included.
- Stackability: Evolve panels can be increased in height in 6”H, 12”H, 18”H or 24”H increments. See Extension Module (pages 82-90) for part numbers.
- Standard in clear (CLR) glass.
- Frosted glass (FRST) 20% upcharge.

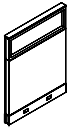
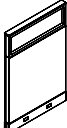
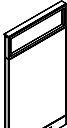
	DESCRIPTION	PRODUCT CODE	LIST PRICE		DIMENSIONS/INCHES		
			Gr1	Gr2	H	W	D
	Monolithic 12”H Glazed Panel - Tempered Glass - 48” High	EVPMGU4818	539	570	48	18	2 7/8
		EVPMGU4824	631	675	48	24	2 7/8
		EVPMGU4830	732	782	48	30	2 7/8
		EVPMGU4836	835	896	48	36	2 7/8
		EVPMGU4842	927	992	48	42	2 7/8
		EVPMGU4848	1008	1084	48	48	2 7/8
		EVPMGU4854	1119	1196	48	54	2 7/8
		EVPMGU4860	1227	1319	48	60	2 7/8
	Monolithic 12”H Glazed Panel - Tempered Glass - 54” High	EVPMGU5418	556	592	54	18	2 7/8
		EVPMGU5424	646	687	54	24	2 7/8
		EVPMGU5430	736	790	54	30	2 7/8
		EVPMGU5436	821	875	54	36	2 7/8
		EVPMGU5442	911	977	54	42	2 7/8
		EVPMGU5448	1008	1084	54	48	2 7/8
		EVPMGU5454	1103	1188	54	54	2 7/8
		EVPMGU5460	1195	1289	54	60	2 7/8
	Monolithic 12”H Glazed Panel - Tempered Glass - 66” High	EVPMGU6618	593	626	66	18	2 7/8
		EVPMGU6624	710	754	66	24	2 7/8
		EVPMGU6630	809	863	66	30	2 7/8
		EVPMGU6636	906	965	66	36	2 7/8
		EVPMGU6642	1007	1073	66	42	2 7/8
		EVPMGU6648	1111	1188	66	48	2 7/8
		EVPMGU6654	1215	1299	66	54	2 7/8
		EVPMGU6660	1324	1414	66	60	2 7/8

EVPLMGU - MONOLITHIC 12”H GLAZED LIGHT PANEL - TEMPERED GLASS

- Monolithic 12”H Glazed Light Panel incorporates a lower fabric module with a 12”H top position glazed module, into a solid steel frame.
- There is no base raceway in Light Panels to accommodate electrical.
- Light Panel Connectors must be used in conjunction with Light Panels.
- Fabric covered modules are tackable and acoustical.
- Opposite sides of each panel may have a different fabric within the same grade at no upcharge.
- If different grades of fabric are used on one panel, the entire panel must be priced at highest grade.
- An aluminum low profile top cap is included.
- Stackability: Evolve panels can be increased in height in 6”H, 12”H, 18”H or 24”H increments. See Extension Module (pages 82-90) for part numbers.
- Standard in clear (CLR) glass.
- Frosted glass (FRST) 20% upcharge.

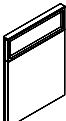
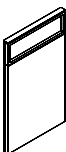
	DESCRIPTION	PRODUCT CODE	LIST PRICE		DIMENSIONS/INCHES		
			Gr1	Gr2	H	W	D
	Monolithic 12”H Glazed Light Panel - Tempered Glass - 48” High	EVPLMGU4818	527	557	48	18	2 7/8
		EVPLMGU4824	616	656	48	24	2 7/8
		EVPLMGU4830	715	766	48	30	2 7/8
		EVPLMGU4836	821	875	48	36	2 7/8
		EVPLMGU4842	909	972	48	42	2 7/8
		EVPLMGU4848	986	1062	48	48	2 7/8
		EVPLMGU4854	1095	1171	48	54	2 7/8
		EVPLMGU4860	1204	1293	48	60	2 7/8
	Monolithic 12”H Glazed Light Panel - Tempered Glass - 54” High	EVPLMGU5418	544	577	54	18	2 7/8
		EVPLMGU5424	633	673	54	24	2 7/8
		EVPLMGU5430	721	773	54	30	2 7/8
		EVPLMGU5436	806	858	54	36	2 7/8
		EVPLMGU5442	896	959	54	42	2 7/8
		EVPLMGU5448	986	1062	54	48	2 7/8
		EVPLMGU5454	1080	1160	54	54	2 7/8
		EVPLMGU5460	1174	1262	54	60	2 7/8
	Monolithic 12”H Glazed Light Panel - Tempered Glass - 66” High	EVPLMGU6618	581	612	66	18	2 7/8
		EVPLMGU6624	696	737	66	24	2 7/8
		EVPLMGU6630	795	842	66	30	2 7/8
		EVPLMGU6636	887	942	66	36	2 7/8
		EVPLMGU6642	984	1052	66	42	2 7/8
		EVPLMGU6648	1088	1161	66	48	2 7/8
		EVPLMGU6654	1191	1272	66	54	2 7/8
		EVPLMGU6660	1295	1383	66	60	2 7/8



EVPFGTU - FABRIC 12”H GLAZED PANEL - TEMPERED GLASS

- Segmented 12”H Glazed Panel incorporates a lower fabric module with a 12”H top position glazed module, into a solid steel frame.
- Panels incorporate 12”H acoustic modules above 30”H base section with a 12”H glazed module at the top.
- Fabric covered modules are tackable and acoustical.
- Opposite sides of each panel may have a different fabric within the same grade at no upcharge.
- If different grades of fabric are used on one panel, the entire panel must be priced at highest grade.
- An aluminum low profile top cap is included.
- Stackability: Evolve panels can be increased in height in 6”H, 12”H, 18”H or 24”H increments. See Extension Module (pages 82-90) for part numbers.
- Standard in clear (CLR) glass.
- Frosted glass (FRST) 20% upcharge.

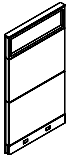
	DESCRIPTION	PRODUCT CODE	LIST PRICE		DIMENSIONS/INCHES		
			Gr1	Gr2	H	W	D
	Fabric 12” Glazed Panel - Tempered Glass 66” High	EVPFGTU6618	665	696	66	18	2 7/8
		EVPFGTU6624	775	818	66	24	2 7/8
		EVPFGTU6630	885	933	66	30	2 7/8
		EVPFGTU6636	989	1048	66	36	2 7/8
		EVPFGTU6642	1118	1180	66	42	2 7/8
		EVPFGTU6648	1213	1286	66	48	2 7/8
		EVPFGTU6654	1355	1435	66	54	2 7/8
		EVPFGTU6660	1493	1580	66	60	2 7/8

EVPLFGTU - FABRIC 12”H GLAZED LIGHT PANEL

- Segmented 12”H Glazed Light Panel incorporates a lower fabric module with a 12”H top position glazed module, into a solid steel frame.
- Panels incorporate 12”H acoustic modules above 30”H base section with a 12”H glazed module at the top.
- There is no base raceway in Light Panels to accommodate electrical.
- Light Panel Connectors must be used in conjunction with Light Panels.
- Opposite sides of each panel may have a different fabric within the same grade at no upcharge.
- If different grades of fabric are used on one panel, the entire panel must be priced at highest grade.
- An aluminum low profile top cap is included.
- Stackability: Evolve panels can be increased in height in 6”H, 12”H, 18”H or 24”H increments.
- See Extension Module (pages 82-90) for part numbers.
- Standard in clear (CLR) glass.
- Frosted glass (FRST) 20% upcharge.

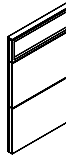
	DESCRIPTION	PRODUCT CODE	LIST PRICE		DIMENSIONS/INCHES		
			Gr1	Gr2	H	W	D
	Fabric 12”H Glazed Light Panel - 66” High	EVPLFGTU6618	649	678	66	18	2 7/8
		EVPLFGTU6624	763	800	66	24	2 7/8
		EVPLFGTU6630	867	911	66	30	2 7/8
		EVPLFGTU6636	972	1026	66	36	2 7/8
		EVPLFGTU6642	1094	1154	66	42	2 7/8
		EVPLFGTU6648	1187	1256	66	48	2 7/8
		EVPLFGTU6654	1327	1403	66	54	2 7/8
		EVPLFGTU6660	1465	1546	66	60	2 7/8

EVFPFGTU - SEGMENTED 12”H GLAZED PANEL - PREMIUM - TEMPERED GLASS

- Segmented 12”H Glazed Premium Panel incorporates a lower fabric module with a 12”H top position glazed module, into a solid steel frame.
- Premium panels incorporate a 6”H base raceway, 24”H base module, 12”H acoustic module and a 12”H glazed module at the top.
- Fabric covered modules are tackable and acoustical.
- Opposite sides of each panel may have a different fabric within the same grade at no upcharge.
- If different grades of fabric are used on one panel, the entire panel must be priced at highest grade.
- An aluminum low profile top cap is included.
- Stackability: Evolve panels can be increased in height in 6”H, 12”H, 18”H or 24”H increments. See Extension Module (pages 82-90) for part numbers.
- Standard in clear (CLR) glass.
- Frosted glass (FRST) 20% upcharge.

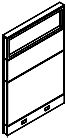
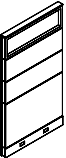
	DESCRIPTION	PRODUCT CODE	LIST PRICE		DIMENSIONS/INCHES		
			Gr1	Gr2	H	W	D
	Segmented 12”H Glazed Premium Panel - Tempered Glass - 54” High	EVFPFGTU5418	612	636	54	18	2 7/8
		EVFPFGTU5424	717	747	54	24	2 7/8
		EVFPFGTU5430	810	849	54	30	2 7/8
		EVFPFGTU5436	911	957	54	36	2 7/8
		EVFPFGTU5442	1022	1072	54	42	2 7/8
		EVFPFGTU5448	1111	1165	54	48	2 7/8
		EVFPFGTU5454	1246	1307	54	54	2 7/8
	Segmented 12”H Glazed Premium Panel - Tempered Glass - 66” High	EVFPFGTU6618	748	777	66	18	2 7/8
		EVFPFGTU6624	878	922	66	24	2 7/8
		EVFPFGTU6630	1000	1046	66	30	2 7/8
		EVFPFGTU6636	1122	1179	66	36	2 7/8
		EVFPFGTU6642	1267	1332	66	42	2 7/8
		EVFPFGTU6648	1371	1444	66	48	2 7/8
		EVFPFGTU6654	1533	1614	66	54	2 7/8
EVFPFGTU6660	1702	1790	66	60	2 7/8		

EVPLFPGTU - SEGMENTED 12”H GLAZED PREMIUM LIGHT PANEL – TEMPERED GLASS

- Segmented 12”H Glazed Premium Light Panel incorporates a lower fabric module with a 12”H top position glazed module, into a solid steel frame.
- Premium panels incorporate a 30”H base section, 12”H acoustic module and a 12”H glazed module at the top.
- There is no base raceway in Light Panels to accommodate electrical.
- Light Panel Connectors must be used in conjunction with Light Panels.
- Opposite sides of each panel may have a different fabric within the same grade at no upcharge.
- If different grades of fabric are used on one panel, the entire panel must be priced at highest grade.
- An aluminum low profile top cap is included.
- Stackability: Evolve panels can be increased in height in 6”H, 12”H, 18”H or 24”H increments.
- See Extension Module (pages 82-90) for part numbers.
- Standard in clear (CLR) glass.
- Frosted glass (FRST) 20% upcharge.

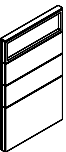
	DESCRIPTION	PRODUCT CODE	LIST PRICE		DIMENSIONS/INCHES		
			Gr1	Gr2	H	W	D
	Segmented 12”H Glazed Premium Panel - Premium - Tempered Glass - 54” High	EVPLFPGTU5418	600	621	54	18	2 7/8
		EVPLFPGTU5424	704	733	54	24	2 7/8
		EVPLFPGTU5430	796	830	54	30	2 7/8
		EVPLFPGTU5436	896	932	54	36	2 7/8
		EVPLFPGTU5442	1004	1052	54	42	2 7/8
		EVPLFPGTU5448	1088	1141	54	48	2 7/8
		EVPLFPGTU5454	1220	1278	54	54	2 7/8
	Segmented 12”H Glazed Premium Panel - Premium - Tempered Glass - 66” High	EVPLFPGTU6618	735	764	66	18	2 7/8
		EVPLFPGTU6624	862	901	66	24	2 7/8
		EVPLFPGTU6630	978	1021	66	30	2 7/8
		EVPLFPGTU6636	1102	1154	66	36	2 7/8
		EVPLFPGTU6642	1242	1304	66	42	2 7/8
		EVPLFPGTU6648	1344	1413	66	48	2 7/8
		EVPLFPGTU6654	1501	1578	66	54	2 7/8
EVPLFPGTU6660	1669	1756	66	60	2 7/8		



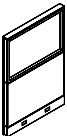
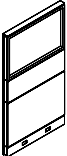

EVPPFGT - PARTLY GLAZED PANEL - TEMPERED GLASS

- Partly Glazed Panel incorporates a lower fabric module with a 12”H or 24”H top position glazed module, into a solid steel frame.
- Opposite sides of each panel may have a different fabric within the same grade at no upcharge.
- If different grades of fabric are used on one panel, the entire panel must be priced at highest grade.
- An aluminum low profile top cap is included.
- Stackability: Evolve panels can be increased in height in 6”H, 12”H, 18”H or 24”H increments. See Extension Module (pages 82-90) for part numbers.
- Standard in clear (CLR) glass.
- Frosted glass (FRST) 20% upcharge.

	DESCRIPTION	PRODUCT CODE	LIST PRICE		DIMENSIONS/INCHES		
			Gr1	Gr2	H	W	D
	Partly Glazed Panel - Tempered Glass - 42" High	EVPPFGT4218	471	489	42	18	2 7/8
		EVPPFGT4224	556	577	42	24	2 7/8
		EVPPFGT4230	629	655	42	30	2 7/8
		EVPPFGT4236	702	732	42	36	2 7/8
		EVPPFGT4242	780	815	42	42	2 7/8
		EVPPFGT4248	854	889	42	48	2 7/8
		EVPPFGT4254	954	992	42	54	2 7/8
		EVPPFGT4260	1053	1099	42	60	2 7/8
	Partly Glazed Panel - Tempered Glass - 54" High	EVPPFGT5418	520	541	54	18	2 7/8
		EVPPFGT5424	604	628	54	24	2 7/8
		EVPPFGT5430	702	728	54	30	2 7/8
		EVPPFGT5436	796	826	54	36	2 7/8
		EVPPFGT5442	889	922	54	42	2 7/8
		EVPPFGT5448	970	1008	54	48	2 7/8
		EVPPFGT5454	1124	1165	54	54	2 7/8
		EVPPFGT5460	1276	1325	54	60	2 7/8
	Partly Glazed Panel - Tempered Glass - 66" High	EVPPFGT6618	659	685	66	18	2 7/8
		EVPPFGT6624	767	798	66	24	2 7/8
		EVPPFGT6630	885	923	66	30	2 7/8
		EVPPFGT6636	1007	1051	66	36	2 7/8
		EVPPFGT6642	1131	1184	66	42	2 7/8
		EVPPFGT6648	1229	1284	66	48	2 7/8
		EVPPFGT6654	1414	1476	66	54	2 7/8
		EVPPFGT6660	1600	1668	66	60	2 7/8

EVPLFGT - PARTLY GLAZED LIGHT PANEL - TEMPERED GLASS

- Partly Glazed Light Panel incorporates a lower fabric module with a 12”H or 24”H top position glazed module, into a solid steel frame.
- There is no base raceway in Light Panels to accommodate electrical.
- Light Panel Connectors must be used in conjunction with Light Panels.
- Opposite sides of each panel may have a different fabric within the same grade at no upcharge.
- If different grades of fabric are used on one panel, the entire panel must be priced at highest grade.
- An aluminum low profile top cap is included.
- Stackability: Evolve panels can be increased in height in 6”H, 12”H, 18”H or 24”H increments. See Extension Module (pages 82-90) for part numbers.
- Standard in clear (CLR) glass.
- Frosted glass (FRST) 20% upcharge.

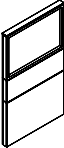
	DESCRIPTION	PRODUCT CODE	LIST PRICE		DIMENSIONS/INCHES		
			Gr1	Gr2	H	W	D
	Partly Glazed Light Panel - Tempered Glass - 42” High	EVPLFGT4218	460	477	42	18	2 7/8
		EVPLFGT4224	544	564	42	24	2 7/8
		EVPLFGT4230	615	641	42	30	2 7/8
		EVPLFGT4236	685	714	42	36	2 7/8
		EVPLFGT4242	767	799	42	42	2 7/8
		EVPLFGT4248	834	869	42	48	2 7/8
		EVPLFGT4254	932	972	42	54	2 7/8
		EVPLFGT4260	1032	1073	42	60	2 7/8
	Partly Glazed Light Panel - Tempered Glass - 54” High	EVPLFGT5418	511	525	54	18	2 7/8
		EVPLFGT5424	593	612	54	24	2 7/8
		EVPLFGT5430	685	710	54	30	2 7/8
		EVPLFGT5436	777	808	54	36	2 7/8
		EVPLFGT5442	872	905	54	42	2 7/8
		EVPLFGT5448	951	984	54	48	2 7/8
		EVPLFGT5454	1103	1141	54	54	2 7/8
		EVPLFGT5460	1251	1295	54	60	2 7/8
	Partly Glazed Light Panel - Tempered Glass - 66” High	EVPLFGT6618	647	673	66	18	2 7/8
		EVPLFGT6624	748	779	66	24	2 7/8
		EVPLFGT6630	867	902	66	30	2 7/8
		EVPLFGT6636	984	1026	66	36	2 7/8
		EVPLFGT6642	1111	1158	66	42	2 7/8
		EVPLFGT6648	1207	1256	66	48	2 7/8
		EVPLFGT6654	1385	1445	66	54	2 7/8
		EVPLFGT6660	1569	1631	66	60	2 7/8



EVPPFGTX - PARTLY GLAZED PANEL - 36”H TEMPERED GLASS

- Partly Glazed Panel incorporates a lower fabric module with 36”H top position glazed module, into a solid steel frame.
- Opposite sides of each panel may have a different fabric within the same grade at no upcharge.
- If different grades of fabric are used on one panel, the entire panel must be priced at highest grade.
- An aluminum low profile top cap is included.
- Stackability: Evolve panels can be increased in height in 6”H, 12”H, 18”H or 24”H increments. See Extension Module (pages 82-90) for part numbers.
- Standard in clear (CLR) glass.
- Frosted glass (FRST) 40% upcharge.

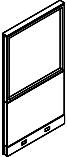
	DESCRIPTION	PRODUCT CODE	LIST PRICE		DIMENSIONS/INCHES		
			Gr1	Gr2	H	W	D
	Fabric 36” Glazed Panel -	EVPPFGTX6618	764	779	66	18	2 7/8
	Tempered Glass - 66” High	EVPPFGTX6624	842	867	66	24	2 7/8
		EVPPFGTX6630	976	1004	66	30	2 7/8
		EVPPFGTX6636	1110	1139	66	36	2 7/8
		EVPPFGTX6642	1241	1274	66	42	2 7/8
		EVPPFGTX6648	1358	1394	66	48	2 7/8
		EVPPFGTX6654	1493	1536	66	54	2 7/8
		EVPPFGTX6660	1628	1675	66	60	2 7/8

EVPLFGTX - PARTLY GLAZED LIGHT PANEL - 36”H TEMPERED GLASS

- Partly Glazed Light Panel incorporates a lower fabric module with 36”H top position glazed module, into a solid steel frame.
- There is no base raceway in Light Panels to accommodate electrical.
- Light Panel Connectors must be used in conjunction with Light Panels.
- Opposite sides of each panel may have a different fabric within the same grade at no upcharge.
- If different grades of fabric are used on one panel, the entire panel must be priced at highest grade.
- An aluminum low profile top cap is included.
- Stackability: Evolve panels can be increased in height in 6”H, 12”H, 18”H or 24”H increments. See Extension Module (pages 82-90) for part numbers.
- Standard in clear (CLR) glass.
- Frosted glass (FRST) 40% upcharge.

	DESCRIPTION	PRODUCT CODE	LIST PRICE		DIMENSIONS/INCHES		
			Gr1	Gr2	H	W	D
	Partly Glazed Light Panel -	EVPLFGTX6618	737	751	66	18	2 7/8
	36”H Tempered Glass - 66” High	EVPLFGTX6624	816	838	66	24	2 7/8
		EVPLFGTX6630	948	970	66	30	2 7/8
		EVPLFGTX6636	1074	1104	66	36	2 7/8
		EVPLFGTX6642	1204	1234	66	42	2 7/8
		EVPLFGTX6648	1317	1353	66	48	2 7/8
		EVPLFGTX6654	1448	1485	66	54	2 7/8
		EVPLFGTX6660	1580	1625	66	60	2 7/8

EVPBFGT - PARTLY GLAZED BELTLINE POWERED PANEL

- Partly Glazed Beltline Powered Panel incorporates fabric modules with a power beltline raceway and a 12”H or 24”H glazed module, within a solid steel frame.
- A Chimney Panel is required to run electric and data from the base to belt.
- 6”H power beltline raceway, to accommodate electrical, is metal with knockouts on both sides.
- Beltline Connectors must be used in conjunction with beltline panels.
- Opposite sides of each panel may have a different fabric within the same grade at no upcharge.
- If different grades of fabric are used on one panel, the entire panel must be priced at highest grade.
- An aluminum low profile top cap is included.
- Stackability: Evolve panels can be increased in height in 6”H, 12”H, 18”H or 24”H increments. See Extension Module (pages 82-90) for part numbers.
- Standard in clear (CLR) glass.
- Frosted glass (FRST) 20% upcharge.

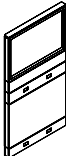
	DESCRIPTION	PRODUCT CODE	LIST PRICE		DIMENSIONS/INCHES		
			Gr1	Gr2	H	W	D
	Partly Glazed Beltline Powered Panel - 54” High	EVPBFGT5424	770	796	54	24	2 7/8
	24” Fabric /6” Power Belt/ 6” Fabric /12” Glass	EVPBFGT5430	902	930	54	30	2 7/8
		EVPBFGT5436	1026	1061	54	36	2 7/8
		EVPBFGT5442	1155	1194	54	42	2 7/8
		EVPBFGT5448	1280	1325	54	48	2 7/8
		EVPBFGT5454	1404	1454	54	54	2 7/8
		EVPBFGT5460	1531	1584	54	60	2 7/8
	Partly Glazed Beltline Powered Panel - 66” High	EVPBFGT6624	874	900	66	24	2 7/8
	24” Fabric /6” Power Belt/ 6” Fabric /24” Glass	EVPBFGT6630	1019	1049	66	30	2 7/8
		EVPBFGT6636	1159	1193	66	36	2 7/8
		EVPBFGT6642	1302	1341	66	42	2 7/8
		EVPBFGT6648	1436	1483	66	48	2 7/8
		EVPBFGT6654	1580	1615	66	54	2 7/8
		EVPBFGT6660	1720	1773	66	60	2 7/8

EVPBLFGT - PARTLY GLAZED BELTLINE POWER LIGHT PANEL

- Partly Glazed Beltline Powered Light Panel incorporates fabric modules with a power beltline raceway and a 12”H or 24”H glazed module, within a solid steel frame.
- 6”H power beltline raceway, to accommodate electrical, is metal with knockouts on both sides.
- There is no base raceway in Light Panels to accommodate electrical.
- Light Beltline Panel Connectors must be used in conjunction with Light Beltline Panels.
- Opposite sides of each panel may have a different fabric within the same grade at no upcharge.
- If different grades of fabric are used on one panel, the entire panel must be priced at highest grade.
- An aluminum low profile top cap is included.
- Stackability: Evolve Light panels can be increased in height in 6”H, 12”H, 18”H or 24”H increments. See Extension Module (pages 82-90) for part numbers.
- Standard in clear (CLR) glass.
- Frosted glass (FRST) 20% upcharge.

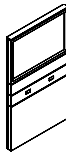
	DESCRIPTION	PRODUCT CODE	LIST PRICE		DIMENSIONS/INCHES		
			Gr1	Gr2	H	W	D
	Partly Glazed Beltline Powered Light Panel - 54” High	EVPBLFGT5424	733	757	54	24	2 7/8
	24” Fabric /6” Power Belt/ 6” Fabric /12” Glass	EVPBLFGT5430	858	886	54	30	2 7/8
		EVPBLFGT5436	974	1009	54	36	2 7/8
		EVPBLFGT5442	1098	1138	54	42	2 7/8
		EVPBLFGT5448	1215	1259	54	48	2 7/8
		EVPBLFGT5454	1335	1385	54	54	2 7/8
		EVPBLFGT5460	1454	1509	54	60	2 7/8
	Partly Glazed Beltline Powered Light Panel - 66” High	EVPBLFGT6624	830	855	66	24	2 7/8
	24” Fabric /6” Power Belt/ 6” Fabric /24” Glass	EVPBLFGT6630	968	999	66	30	2 7/8
		EVPBLFGT6636	1102	1136	66	36	2 7/8
		EVPBLFGT6642	1235	1276	66	42	2 7/8
		EVPBLFGT6648	1368	1413	66	48	2 7/8
		EVPBLFGT6654	1501	1549	66	54	2 7/8
		EVPBLFGT6660	1632	1688	66	60	2 7/8



EVPBCFGT - PARTLY GLAZED BELTLINE POWERED CHIMNEY PANEL - TEMPERED GLASS

- Partly Glazed Beltline Powered Chimney Panel incorporates fabric modules with a power beltline raceway and a 12”H or 24”H glazed module, within a solid steel frame.
- A Chimney Panel is required to run electric and data from the base to belt.
- Separate electric harness required to go from base to belt (see EVE8CPCP).
- 6”H power beltline raceway, to accommodate electrical, is metal with knockouts on both sides.
- Beltline Connectors must be used in conjunction with beltline panels.
- Opposite sides of each panel may have a different fabric within the same grade at no upcharge.
- If different grades of fabric are used on one panel, the entire panel must be priced at highest grade.
- An aluminum low profile top cap is included.
- Stackability: Evolve panels can be increased in height in 6”H, 12”H, 18”H or 24”H increments. See Extension Module (pages 82-90) for part numbers.
- Standard in clear (CLR) glass.
- Frosted glass (FRST) 20% upcharge.

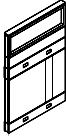
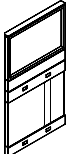
	DESCRIPTION	PRODUCT CODE	LIST PRICE		DIMENSIONS/INCHES		
			Gr1	Gr2	H	W	D
	Partly Glazed Beltline Powered Chimney Panel - Tempered Glass - 54” High	EVPBCFGT5436	1105	1141	54	36	2 7/8
	24” Fabric Chimney /6” Power Belt / 6” Fabric /12” Glass	EVPBCFGT5442	1235	1276	54	42	2 7/8
	Partly Glazed Beltline Powered Chimney Panel - Tempered Glass - 66” High	EVPBCFGT6636	1254	1290	66	36	2 7/8
	24” Fabric Chimney /6” Power Belt / 6” Fabric /24” Glass	EVPBCFGT6642	1383	1423	66	42	2 7/8

EVE8CPCP - CHIMNEY PANEL JUMPER CABLE KIT

- Contains two (2) 17” flexible harnesses and one (1) “I” connector.
- Used to connect electric from the base to the beltline raceway in Beltline Powered Chimney panel.
- Must use in conjunction with base power distribution harness and beltline power distribution harness (sold separately)

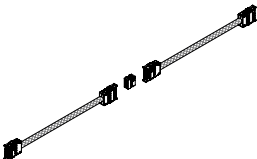
	DESCRIPTION	PRODUCT CODE	LIST PRICE	DIMENSIONS/INCHES		
				H	W	D
	Chimney Panel Jumper Cable Kit	EVE8CPCP	341			

EVFPFGT - PARTLY GLAZED PREMIUM PANEL - TEMPERED GLASS

- Partly Glazed Premium Panel incorporates 12”H glazed modules above 30”H fabric base section.
- Opposite sides of each panel may have a different fabric within the same grade at no upcharge.
- If different grades of fabric are used on one panel, the entire panel must be priced at highest grade.
- An aluminum low profile top cap is included.
- Stackability: Evolve panels can be increased in height in 6”H, 12”H, 18”H or 24”H increments. See Extension Module (pages 82-90) for part numbers.
- Standard in clear (CLR) glass.
- Frosted glass (FRST) 20% upcharge.

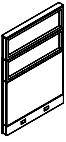
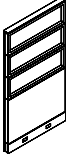
	DESCRIPTION	PRODUCT CODE	LIST PRICE		DIMENSIONS/INCHES		
			Gr1	Gr2	H	W	D
	Partly Glazed Premium Panel - Tempered Glass - 54” High	EVFPFGT5418	629	648	54	18	2 7/8
		EVFPFGT5424	748	769	54	24	2 7/8
		EVFPFGT5430	839	867	54	30	2 7/8
		EVFPFGT5436	932	963	54	36	2 7/8
		EVFPFGT5442	1040	1073	54	42	2 7/8
		EVFPFGT5448	1144	1182	54	48	2 7/8
		EVFPFGT5454	1280	1323	54	54	2 7/8
		EVFPFGT5460	1412	1460	54	60	2 7/8
	Partly Glazed Premium Panel - Tempered Glass - 66” High	EVFPFGT6618	784	802	66	18	2 7/8
		EVFPFGT6624	942	969	66	24	2 7/8
		EVFPFGT6630	1058	1083	66	30	2 7/8
		EVFPFGT6636	1163	1193	66	36	2 7/8
		EVFPFGT6642	1297	1332	66	42	2 7/8
		EVFPFGT6648	1433	1474	66	48	2 7/8
		EVFPFGT6654	1620	1666	66	54	2 7/8
		EVFPFGT6660	1803	1851	66	60	2 7/8

EVPLFPGT - PARTLY GLAZED PREMIUM LIGHT PANEL – TEMPERED GLASS

- Partly Glazed Premium Panel incorporates 12”H glazed modules above 30”H fabric base section.
- There is no base raceway in Light Panels to accommodate electrical.
- Light Panel Connectors must be used in conjunction with Light Panels.
- Opposite sides of each panel may have a different fabric within the same grade at no upcharge.
- If different grades of fabric are used on one panel, the entire panel must be priced at highest grade.
- An aluminum low profile top cap is included.
- Stackability: Evolve panels can be increased in height in 6”H, 12”H, 18”H or 24”H increments.
- See Extension Module (pages 82-90) for part numbers.
- Standard in clear (CLR) glass.
- Frosted glass (FRST) 20% upcharge.

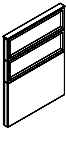
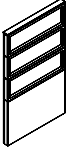
	DESCRIPTION	PRODUCT CODE	LIST PRICE		DIMENSIONS/INCHES		
			Gr1	Gr2	H	W	D
	Partly Glazed Premium Light Panel - Tempered Glass - 54” High	EVPLFPGT5418	608	626	54	18	2 7/8
		EVPLFPGT5424	728	745	54	24	2 7/8
		EVPLFPGT5430	813	838	54	30	2 7/8
		EVPLFPGT5436	908	932	54	36	2 7/8
		EVPLFPGT5442	1009	1040	54	42	2 7/8
		EVPLFPGT5448	1111	1144	54	48	2 7/8
		EVPLFPGT5454	1241	1281	54	54	2 7/8
		EVPLFPGT5460	1369	1414	54	60	2 7/8
	Partly Glazed Premium Light Panel - Tempered Glass - 66” High	EVPLFPGT6618	764	775	66	18	2 7/8
		EVPLFPGT6624	916	938	66	24	2 7/8
		EVPLFPGT6630	1022	1049	66	30	2 7/8
		EVPLFPGT6636	1129	1159	66	36	2 7/8
		EVPLFPGT6642	1260	1291	66	42	2 7/8
		EVPLFPGT6648	1389	1426	66	48	2 7/8
		EVPLFPGT6654	1570	1610	66	54	2 7/8
		EVPLFPGT6660	1752	1793	66	60	2 7/8



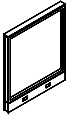
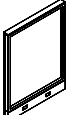
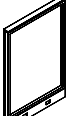
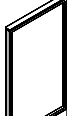

EVPXGT - FULLY GLAZED MONOLITHIC PANEL - TEMPERED GLASS

- Fully Glazed Monolithic Panels are incorporated into a solid steel frame.
- An aluminum low profile top cap is included.
- Stackability: Evolve panels can be increased in height in 6"H, 12"H, 18"H or 24"H increments. See Extension Module (pages 82-90) for part numbers.
- Standard in clear (CLR) glass.
- Frosted glass (FRST) 40% upcharge.

	DESCRIPTION	PRODUCT CODE	LIST PRICE	DIMENSIONS/INCHES		
				H	W	D
	Fully Glazed Monolithic Panel - Tempered Glass - 42" High	EVPXGT4218	504	42	18	2 7/8
		EVPXGT4224	556	42	24	2 7/8
		EVPXGT4230	646	42	30	2 7/8
		EVPXGT4236	726	42	36	2 7/8
		EVPXGT4242	808	42	42	2 7/8
	Fully Glazed Monolithic Panel - Tempered Glass - 48" High	EVPXGT4818	450	48	18	2 7/8
		EVPXGT4824	575	48	24	2 7/8
		EVPXGT4830	635	48	30	2 7/8
		EVPXGT4836	784	48	36	2 7/8
		EVPXGT4842	827	48	42	2 7/8
	Fully Glazed Monolithic Panel - Tempered Glass - 54" High	EVPXGT5418	558	54	18	2 7/8
		EVPXGT5424	656	54	24	2 7/8
		EVPXGT5430	763	54	30	2 7/8
		EVPXGT5436	858	54	36	2 7/8
		EVPXGT5442	951	54	42	2 7/8
	Fully Glazed Monolithic Panel - Tempered Glass - 66" High	EVPXGT6618	655	66	18	2 7/8
		EVPXGT6624	757	66	24	2 7/8
		EVPXGT6630	874	66	30	2 7/8
		EVPXGT6636	983	66	36	2 7/8
		EVPXGT6642	1094	66	42	2 7/8

EVPLXGT - FULLY GLAZED MONOLITHIC LIGHT PANEL - TEMPERED GLASS

- Fully Glazed Monolithic Light Panels are incorporated into a solid steel frame.
- There is no base raceway in Light Panels to accommodate electrical.
- Light Panel Connectors must be used in conjunction with Light Panels.
- An aluminum low profile top cap is included.
- Stackability: Evolve panels can be increased in height in 6”H, 12”H, 18”H or 24”H increments. See Extension Module (pages 82-90) for part numbers.
- Standard in clear (CLR) glass.
- Frosted glass (FRST) 40% upcharge.

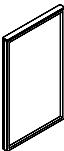
	DESCRIPTION	PRODUCT CODE	LIST PRICE	DIMENSIONS/INCHES		
				H	W	D
	Fully Glazed Monolithic Light Panel - Tempered Glass - 42” High	EVPLXGT4218	479	42	18	2 7/8
		EVPLXGT4224	528	42	24	2 7/8
		EVPLXGT4230	613	42	30	2 7/8
		EVPLXGT4236	687	42	36	2 7/8
		EVPLXGT4242	768	42	42	2 7/8
	Fully Glazed Monolithic Light Panel - Tempered Glass - 48” High	EVPLXGT4818	424	48	18	2 7/8
		EVPLXGT4824	546	48	24	2 7/8
		EVPLXGT4830	604	48	30	2 7/8
		EVPLXGT4836	746	48	36	2 7/8
		EVPLXGT4842	781	48	42	2 7/8
	Fully Glazed Monolithic Light Panel - Tempered Glass - 54”	EVPLXGT5418	533	54	18	2 7/8
		EVPLXGT5424	625	54	24	2 7/8
		EVPLXGT5430	719	54	30	2 7/8
		EVPLXGT5436	813	54	36	2 7/8
		EVPLXGT5442	902	54	42	2 7/8
	Fully Glazed Monolithic Light Panel - Tempered Glass - 66” High	EVPLXGT6618	624	66	18	2 7/8
		EVPLXGT6624	718	66	24	2 7/8
		EVPLXGT6630	831	66	30	2 7/8
		EVPLXGT6636	932	66	36	2 7/8
		EVPLXGT6642	1040	66	42	2 7/8

EVPGT - FULLY GLAZED SEGMENTED PANEL - TEMPERED GLASS

- Fully Glazed Segmented Panel incorporates (2) 24”H Glazed modules into a solid steel frame.
- An aluminum low profile top cap is included.
- Stackability: Evolve panels can be increased in height in 6”H, 12”H, 18”H or 24”H increments. See Extension Module (pages 82-90) for part numbers.
- Standard in clear (CLR) glass.
- Frosted glass (FRST) 40% upcharge.

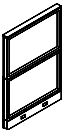
	DESCRIPTION	PRODUCT CODE	LIST PRICE	DIMENSIONS/INCHES		
				H	W	D
	Fully Glazed Segmented Panel - Tempered Glass - 54” High	EVPGT5418	714	54	18	2 7/8
		EVPGT5424	875	54	24	2 7/8
		EVPGT5430	968	54	30	2 7/8
		EVPGT5436	1058	54	36	2 7/8
		EVPGT5442	1171	54	42	2 7/8
		EVPGT5448	1306	54	48	2 7/8
		EVPGT5454	1436	54	54	2 7/8
		EVPGT5460	1569	54	60	2 7/8





EVPLGT - FULLY GLAZED SEGMENTED LIGHT PANEL - TEMPERED GLASS

- Fully Glazed Segmented Light Panel incorporates (2) 24”H Glazed modules into a solid steel frame.
- There is no base raceway in Light Panels to accommodate electrical.
- Light Panel Connectors must be used in conjunction with Light Panels.
- An aluminum low profile top cap is included.
- Stackability: Evolve panels can be increased in height in 6”H, 12”H, 18”H or 24”H increments. See Extension Module (pages 82-90) for part numbers.
- Standard in clear (CLR) glass.
- Frosted glass (FRST) 40% upcharge.

	DESCRIPTION	PRODUCT CODE	LIST PRICE	DIMENSIONS/INCHES		
				H	W	D
	Fully Glazed Segmented Light Panel Tempered Glass - 54” High	EVPLGT5418	678	54	18	2 7/8
		EVPLGT5424	833	54	24	2 7/8
		EVPLGT5430	920	54	30	2 7/8
		EVPLGT5436	1004	54	36	2 7/8
		EVPLGT5442	1115	54	42	2 7/8
		EVPLGT5448	1240	54	48	2 7/8
		EVPLGT5454	1366	54	54	2 7/8
		EVPLGT5460	1489	54	60	2 7/8



EVPGPT - FULLY GLAZED PREMIUM PANEL - TEMPERED GLASS

- Fully Glazed Premium Panel incorporates 12”H Glazed Modules into a solid steel frame.
- An aluminum low profile top cap is included.
- Stackability: Evolve panels can be increased in height in 6”H, 12”H, 18”H or 24”H increments. See Extension Module (pages 82-90) for part numbers.
- Standard in clear (CLR) glass.
- Frosted glass (FRST) 40% upcharge.

	DESCRIPTION	PRODUCT CODE	LIST PRICE	DIMENSIONS/INCHES		
				H	W	D
	Fully Glazed Premium Panel - Tempered Glass - 42” High	EVPGPT4218	704	42	18	2 7/8
		EVPGPT4224	862	42	24	2 7/8
		EVPGPT4230	954	42	30	2 7/8
		EVPGPT4236	1040	42	36	2 7/8
		EVPGPT4242	1154	42	42	2 7/8
		EVPGPT4248	1282	42	48	2 7/8
		EVPGPT4254	1413	42	54	2 7/8
		EVPGPT4260	1539	42	60	2 7/8
	Fully Glazed Premium Panel - Tempered Glass - 54” High	EVPGPT5418	890	54	18	2 7/8
		EVPGPT5424	1094	54	24	2 7/8
		EVPGPT5430	1210	54	30	2 7/8
		EVPGPT5436	1317	54	36	2 7/8
		EVPGPT5442	1465	54	42	2 7/8
		EVPGPT5448	1630	54	48	2 7/8
		EVPGPT5454	1798	54	54	2 7/8
		EVPGPT5460	1960	54	60	2 7/8
	Fully Glazed Premium Panel - Tempered Glass - 66” High	EVPGPT6618	1078	66	18	2 7/8
		EVPGPT6624	1326	66	24	2 7/8
		EVPGPT6630	1467	66	30	2 7/8
		EVPGPT6636	1595	66	36	2 7/8
		EVPGPT6642	1771	66	42	2 7/8
		EVPGPT6648	1972	66	48	2 7/8
		EVPGPT6654	2176	66	54	2 7/8
		EVPGPT6660	2379	66	60	2 7/8

EVPLGPT - FULLY GLAZED PREMIUM LIGHT PANEL - TEMPERED GLASS

- Fully Glazed Premium Light Panel incorporates 12"H Glazed Modules into a solid steel frame.
- There is no base raceway in Light Panels to accommodate electrical.
- Light Panel Connectors must be used in conjunction with Light Panels.
- An aluminum low profile top cap is included.
- Stackability: Evolve panels can be increased in height in 6"H, 12"H, 18"H or 24"H increments. See Extension Module (pages 82-90) for part numbers.
- Standard in clear (CLR) glass.
- Frosted glass (FRST) 40% upcharge.

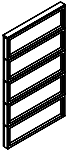
	DESCRIPTION	PRODUCT CODE	LIST PRICE	DIMENSIONS/INCHES		
				H	W	D
	Fully Glazed Premium Light Panel - Tempered Glass - 42" High	EVPLGPT4218	682	42	18	2 7/8
		EVPLGPT4224	834	42	24	2 7/8
		EVPLGPT4230	923	42	30	2 7/8
		EVPLGPT4236	1009	42	36	2 7/8
		EVPLGPT4242	1119	42	42	2 7/8
		EVPLGPT4248	1243	42	48	2 7/8
		EVPLGPT4254	1371	42	54	2 7/8
		EVPLGPT4260	1493	42	60	2 7/8
	Fully Glazed Premium Light Panel - Tempered Glass - 54" High	EVPLGPT5418	866	54	18	2 7/8
		EVPLGPT5424	1062	54	24	2 7/8
		EVPLGPT5430	1171	54	30	2 7/8
		EVPLGPT5436	1280	54	36	2 7/8
		EVPLGPT5442	1422	54	42	2 7/8
		EVPLGPT5448	1581	54	48	2 7/8
		EVPLGPT5454	1741	54	54	2 7/8
		EVPLGPT5460	1900	54	60	2 7/8
	Fully Glazed Premium Light Panel - Tempered Glass - 66" High	EVPLGPT6618	1048	66	18	2 7/8
		EVPLGPT6624	1285	66	24	2 7/8
		EVPLGPT6630	1424	66	30	2 7/8
		EVPLGPT6636	1546	66	36	2 7/8
		EVPLGPT6642	1720	66	42	2 7/8
		EVPLGPT6648	1914	66	48	2 7/8
		EVPLGPT6654	2109	66	54	2 7/8
		EVPLGPT6660	2307	66	60	2 7/8



EVPHSG - RECEPTION PANEL LAMINATE

- Reception panel incorporates glazed module and pass thru module within steel frame. Glazing is clear only.
- 6" H or 12" H pass thru with sliding glass door module.
- 24" H Laminate bottom module.
- Aluminum low profile top is included.
- Stackability: Evolve panels can be increased in height in 6", 12", 24" increments. See module listing for part numbers.

	DESCRIPTION	PRODUCT CODE	LIST PRICE	DIMENSIONS/INCHES		
				H	W	D
	Reception Panel with 12" H Pass Thru	EVPHSG2M6636	1444	66	36	2 7/8
		EVPHSG2M6642	1561	66	42	2 7/8
		EVPHSG2M6648	1688	66	48	2 7/8

EVPHSG - RECEPTION PANEL LAMINATE

- Reception panel incorporates glazed module and pass thru module within steel frame. Glazing is clear only.
- 6" H pass thru with sliding glass door module.
- 30" H Laminate bottom module.
- Aluminum low profile top is included.
- Stackability: Evolve panels can be increased in height in 6", 12", 24" increments. See module listing for part numbers.

	DESCRIPTION	PRODUCT CODE	LIST PRICE	DIMENSIONS/INCHES		
				H	W	D
	Reception Panel with 6" H Pass Thru	EVPHSG3M6636	1499	66	36	2 7/8
		EVPHSG3M6642	1611	66	42	2 7/8
		EVPHSG3M6648	1764	66	48	2 7/8

EVPHSG - RECEPTION PANEL LAMINATE

- Reception panel incorporates glazed module and pass thru module within steel frame. Glazing is clear only.
- 6" H or 12" H pass thru with sliding glass door module.
- 24" H Laminate bottom module.
- Aluminum low profile top is included.
- Stackability: Evolve panels can be increased in height in 6", 12", 24" increments. See module listing for part numbers.

	DESCRIPTION	PRODUCT CODE	LIST PRICE	DIMENSIONS/INCHES		
				H	W	D
	Reception Panel with 6" H Pass Thru	EVPHSG5M6636	1477	66	36	2 7/8
		EVPHSG5M6642	1595	66	42	2 7/8
		EVPHSG5M6648	1722	66	48	2 7/8

EVPHSG - RECEPTION PANEL FABRIC

- Reception panel incorporates glazed module and pass thru module within steel frame. Glazing is clear only.
- 6" H or 12" H pass thru with sliding glass door module.
- 24" H Fabric bottom module.
- Aluminum low profile top is included.
- Stackability: Evolve panels can be increased in height in 6", 12", 24" increments. See module listing for part numbers.

	DESCRIPTION	PRODUCT CODE	LIST PRICE		DIMENSIONS/INCHES		
			Gr1	Gr2	H	W	D
	Reception Panel with 12" H Pass Thru	EVPHSG2M6636	1291	1319	66	36	2 7/8
		EVPHSG2M6642	1422	1457	66	42	2 7/8
		EVPHSG2M6648	1566	1601	66	48	2 7/8

EVPHSG - RECEPTION PANEL FABRIC

- Reception panel incorporates glazed module and pass thru module within steel frame. Glazing is clear only.
- 6" H pass thru with sliding glass door module.
- 30" H Fabric bottom module.
- Aluminum low profile top is included.
- Stackability: Evolve panels can be increased in height in 6", 12", 24" increments. See module listing for part numbers.

	DESCRIPTION	PRODUCT CODE	LIST PRICE		DIMENSIONS/INCHES		
			Gr1	Gr2	H	W	D
	Reception Panel with 6" H Pass Thru	EVPHSG3M6636	1362	1391	66	36	2 7/8
		EVPHSG3M6642	1485	1520	66	42	2 7/8
		EVPHSG3M6648	1611	1646	66	48	2 7/8

EVPHSG - RECEPTION PANEL FABRIC

- Reception panel incorporates glazed module and pass thru module within steel frame. Glazing is clear only.
- 6" H or 12" H pass thru with sliding glass door module.
- 24" H Fabric bottom module.
- Aluminum low profile top is included.
- Stackability: Evolve panels can be increased in height in 6", 12", 24" increments. See module listing for part numbers.

	DESCRIPTION	PRODUCT CODE	LIST PRICE		DIMENSIONS/INCHES		
			Gr1	Gr2	H	W	D
	Reception Panel with 6" H Pass Thru	EVPHSG5M6636	1313	1342	66	36	2 7/8
		EVPHSG5M6642	1462	1495	66	42	2 7/8
		EVPHSG5M6648	1609	1644	66	48	2 7/8

EVSLs - LAMINATED SHELF FOR RECEPTION PANEL



- Laminated Wood Shelf Panel Mounted.
- Shelf thickness 1".
- Available in LP.
- Includes attachment hardware.

	DESCRIPTION	PRODUCT CODE	LIST PRICE	DIMENSIONS/INCHES		
				H	W	D
	Reception Panel Shelf	EVSLs1218	258	1.125	18	12
		EVSLs1224	277	1.125	24	12
		EVSLs1230	294	1.125	30	12
		EVSLs1236	313	1.125	36	12
		EVSLs1242	330	1.125	42	12
		EVSLs1248	349	1.125	48	12



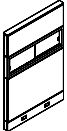
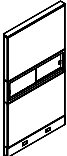

EVPFSG - PASS-THRU SLIDING DOOR GLAZED PANEL - TEMPERED GLASS

- Pass-Thru Sliding Door Glazed Panel incorporates fabric modules on upper and lower positions, with Middle 12”H Pass-Thru Sliding Door module, into a solid steel frame.
- Tracks for Sliding glass door available in Tungsten only.
- Opposite sides of each panel may have a different fabric within the same grade at no upcharge.
- If different grades of fabric are used on one panel, the entire panel must be priced at highest grade.
- An aluminum low profile top cap is included.
- Stackability: Evolve panels can be increased in height in 6”H, 12”H, 18”H or 24”H increments. See Extension Module (pages 82-90) for part numbers.
- Standard in clear (CLR) glass.
- Frosted glass (FRST) 20% upcharge.

	DESCRIPTION	PRODUCT CODE	LIST PRICE		DIMENSIONS/INCHES		
			Gr1	Gr2	H	W	D
	Pass-Thru Sliding Door Glazed Panel - Tempered Glass - 54” High	EVPFSG5424	717	746	54	24	2 7/8
		EVPFSG5430	810	847	54	30	2 7/8
		EVPFSG5436	911	954	54	36	2 7/8
		EVPFSG5442	1022	1072	54	42	2 7/8
		EVPFSG5448	1111	1162	54	48	2 7/8
		EVPFSG5454	1246	1304	54	54	2 7/8
		EVPFSG5460	1377	1444	54	60	2 7/8
	Pass-Thru Sliding Door Glazed Panel - Tempered Glass - 66” High	EVPFSG6624	775	814	66	24	2 7/8
		EVPFSG6630	885	930	66	30	2 7/8
		EVPFSG6636	989	1048	66	36	2 7/8
		EVPFSG6642	1118	1179	66	42	2 7/8
		EVPFSG6648	1213	1282	66	48	2 7/8
		EVPFSG6654	1355	1432	66	54	2 7/8
		EVPFSG6660	1525	1578	66	60	2 7/8
	Pass-Thru Sliding Door Glazed Panel - Tempered Glass - 66” High	EVPFPSG6624	775	814	66	24	2 7/8
		EVPFPSG6630	885	930	66	30	2 7/8
		EVPFPSG6636	989	1048	66	36	2 7/8
		EVPFPSG6642	1118	1179	66	42	2 7/8
		EVPFPSG6648	1213	1282	66	48	2 7/8
		EVPFPSG6654	1355	1432	66	54	2 7/8
		EVPFPSG6660	1525	1578	66	60	2 7/8

EVPFSGX - FABRIC GLAZED PASS-THRU SLIDING DOOR PANEL - TEMPERED GLASS

- Pass-Thru Sliding Door Glazed Panel incorporates fabric modules with 12”H or 24”H Pass-Thru Sliding Door module, into a solid steel frame.
- Tracks for Sliding glass door available in Tungsten only.
- Opposite sides of each panel may have a different fabric within the same grade at no upcharge.
- If different grades of fabric are used on one panel, the entire panel must be priced at highest grade.
- An aluminum low profile top cap is included.
- Stackability: Evolve panels can be increased in height in 6”H, 12”H, 18”H or 24”H increments. See Extension Module (pages 82-90) for part numbers.
- Standard in clear (CLR) glass.
- Frosted glass (FRST) 20% upcharge.

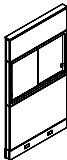
	DESCRIPTION	PRODUCT CODE	LIST PRICE		DIMENSIONS/INCHES		
			Gr1	Gr2	H	W	D
	Fabric Glazed Pass-Thru Sliding Door Panel - Tempered Glass - 42” High	EVPFSGX4224	556	575	42	24	2 7/8
		EVPFSGX4230	629	652	42	30	2 7/8
		EVPFSGX4236	702	730	42	36	2 7/8
		EVPFSGX4242	780	813	42	42	2 7/8
		EVPFSGX4248	854	887	42	48	2 7/8
		EVPFSGX4254	954	989	42	54	2 7/8
		EVPFSGX4260	1053	1095	42	60	2 7/8
	Fabric Glazed Pass-Thru Sliding Door Panel - Tempered Glass - 54” High	EVPFSGX5424	604	625	54	24	2 7/8
		EVPFSGX5430	702	725	54	30	2 7/8
		EVPFSGX5436	796	824	54	36	2 7/8
		EVPFSGX5442	889	921	54	42	2 7/8
		EVPFSGX5448	970	1006	54	48	2 7/8
		EVPFSGX5454	1124	1162	54	54	2 7/8
		EVPFSGX5460	1276	1324	54	60	2 7/8
	Fabric Glazed Pass-Thru Sliding Door Panel - Tempered Glass - 66” High	EVPFSGX6624	767	797	66	24	2 7/8
		EVPFSGX6630	885	920	66	30	2 7/8
		EVPFSGX6636	1007	1048	66	36	2 7/8
		EVPFSGX6642	1131	1182	66	42	2 7/8
		EVPFSGX6648	1229	1282	66	48	2 7/8
		EVPFSGX6654	1414	1473	66	54	2 7/8
		EVPFSGX6660	1600	1666	66	60	2 7/8



EVPF1S - SLATWALL PANEL - SINGLE SIDED

- Slatwall Panel incorporates fabric modules with a single 12”H or 24”H top position slatwall module, into a solid steel frame.
- 66”H panel can be configured with either a 24”H slatwall module at the top or a 12”H slatwall at the middle Position (EVPF1S66xxM)
- Opposite side is fabric covered.
- Slatwall is made of aluminum.
- Accessories can be used on slatwall modules. Please see accessory section for additional details.
- Opposite sides of each panel may have a different fabric within the same grade at no upcharge.
- If different grades of fabric are used on one panel, the entire panel must be priced at highest grade.
- An aluminum low profile top cap is included.
- Stackability: Evolve panels can be increased in height in 6”H, 12”H, 18”H or 24”H increments. See Extension Module (pages 82-90) for part numbers.

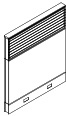
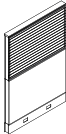
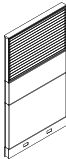
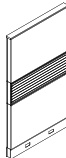
	DESCRIPTION	PRODUCT CODE	LIST PRICE		DIMENSIONS/INCHES		
			Gr1	Gr2	H	W	D
	Slatwall Panel - Single Sided - 42” High	EVPF1S4218	525	546	42	18	2 7/8
		EVPF1S4224	626	654	42	24	2 7/8
		EVPF1S4230	734	765	42	30	2 7/8
		EVPF1S4236	839	875	42	36	2 7/8
		EVPF1S4242	954	992	42	42	2 7/8
		EVPF1S4248	1037	1084	42	48	2 7/8
		EVPF1S4254	1152	1200	42	54	2 7/8
		EVPF1S4260	1260	1317	42	60	2 7/8
	Slatwall Panel - Single Sided - 54” High	EVPF1S5418	618	643	54	18	2 7/8
		EVPF1S5424	744	774	54	24	2 7/8
		EVPF1S5430	869	907	54	30	2 7/8
		EVPF1S5436	1000	1039	54	36	2 7/8
		EVPF1S5442	1129	1180	54	42	2 7/8
		EVPF1S5448	1231	1288	54	48	2 7/8
		EVPF1S5454	1372	1433	54	54	2 7/8
		EVPF1S5460	1509	1570	54	60	2 7/8
	Slatwall Panel - Single Sided - 66” High	EVPF1S6618	785	813	66	18	2 7/8
		EVPF1S6624	942	986	66	24	2 7/8
		EVPF1S6630	1104	1154	66	30	2 7/8
		EVPF1S6636	1272	1322	66	36	2 7/8
		EVPF1S6642	1446	1512	66	42	2 7/8
		EVPF1S6648	1573	1637	66	48	2 7/8
		EVPF1S6654	1752	1822	66	54	2 7/8
		EVPF1S6660	1930	2007	66	60	2 7/8
	Slat Wall Panel - Single Sided - Middle Module - 66” High	EVPF1S6618M	765	800	66	18	2 7/8
		EVPF1S6624M	920	966	66	24	2 7/8
		EVPF1S6630M	1073	1127	66	30	2 7/8
		EVPF1S6636M	1235	1299	66	36	2 7/8
		EVPF1S6642M	1406	1480	66	42	2 7/8
		EVPF1S6648M	1531	1612	66	48	2 7/8
		EVPF1S6654M	1702	1793	66	54	2 7/8
		EVPF1S6660M	1873	1972	66	60	2 7/8

EVPLF1S - SLATWALL LIGHT PANEL - SINGLE SIDED

- Slatwall Light Panel incorporates fabric modules with a single 12”H or 24”H top position slatwall module, into a solid steel frame.
- 66”H panel can be configured with either a 24”H slatwall module at the top or a 12”H slatwall at the middle Position (EVPLF1S66xxM)
- Opposite side is fabric covered
- Slatwall is made of aluminum.
- Accessories can be used on slatwall modules. Please see accessory section for additional details.
- There is no base raceway in Light Panels to accommodate electrical.
- Light Panel Connectors must be used in conjunction with Light Panels.
- Opposite sides of each panel may have a different fabric within the same grade at no upcharge.
- If different grades of fabric are used on one panel, the entire panel must be priced at highest grade.
- An aluminum low profile top cap is included.
- Stackability: Evolve panels can be increased in height in 6”H, 12”H, 18”H or 24”H increments. See Extension Module (pages 82-90) for part numbers.

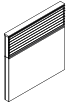
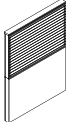
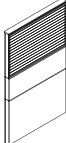
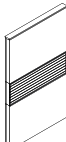
	DESCRIPTION	PRODUCT CODE	LIST PRICE		DIMENSIONS/INCHES		
			Gr1	Gr2	H	W	D
	Slatwall Light Panel - Single Sided- 42” High	EVPLF1S4218	513	534	42	18	2 7/8
		EVPLF1S4224	613	641	42	24	2 7/8
		EVPLF1S4230	718	747	42	30	2 7/8
		EVPLF1S4236	824	857	42	36	2 7/8
		EVPLF1S4242	932	972	42	42	2 7/8
		EVPLF1S4248	1017	1060	42	48	2 7/8
		EVPLF1S4254	1127	1175	42	54	2 7/8
		EVPLF1S4260	1235	1290	42	60	2 7/8
	Slatwall Light Panel - Single Sided - 54” High	EVPLF1S5418	605	626	54	18	2 7/8
		EVPLF1S5424	730	757	54	24	2 7/8
		EVPLF1S5430	854	887	54	30	2 7/8
		EVPLF1S5436	978	1018	54	36	2 7/8
		EVPLF1S5442	1107	1154	54	42	2 7/8
		EVPLF1S5448	1210	1262	54	48	2 7/8
		EVPLF1S5454	1345	1403	54	54	2 7/8
		EVPLF1S5460	1479	1535	54	60	2 7/8
	Slatwall Light Panel - Single Sided - 66” High	EVPLF1S6618	770	796	66	18	2 7/8
		EVPLF1S6624	923	965	66	24	2 7/8
		EVPLF1S6630	1081	1127	66	30	2 7/8
		EVPLF1S6636	1246	1294	66	36	2 7/8
		EVPLF1S6642	1417	1479	66	42	2 7/8
		EVPLF1S6648	1540	1604	66	48	2 7/8
		EVPLF1S6654	1714	1781	66	54	2 7/8
		EVPLF1S6660	1892	1965	66	60	2 7/8
	Slatwall Light Panel - Single Sided - Middle Module - 66” High	EVPLF1S6618M	747	779	66	18	2 7/8
		EVPLF1S6624M	902	942	66	24	2 7/8
		EVPLF1S6630M	1053	1103	66	30	2 7/8
		EVPLF1S6636M	1213	1273	66	36	2 7/8
		EVPLF1S6642M	1378	1448	66	42	2 7/8
		EVPLF1S6648M	1500	1577	66	48	2 7/8
		EVPLF1S6654M	1669	1757	66	54	2 7/8
		EVPLF1S6660M	1835	1931	66	60	2 7/8



EVPF2S - SLATWALL PANEL - DOUBLE SIDED

- Slatwall Panel incorporates fabric modules with a single 12”H or 24”H top position slatwall module, into a solid steel frame.
- 66”H panel can be configured with either a 24”H slatwall module at the top or a 12”H slatwall at the middle Position (EVPF2S66xxM)
- Slatwall module has slatwall on both sides.
- Slatwall is made of aluminum.
- Accessories can be used on slatwall modules. Please see accessory section for additional details.
- Opposite sides of each panel may have a different fabric within the same grade at no upcharge.
- If different grades of fabric are used on one panel, the entire panel must be priced at highest grade.
- An aluminum low profile top cap is included.
- Stackability: Evolve panels can be increased in height in 6”H, 12”H, 18”H or 24”H increments. See Extension Module (pages 82-90) for part numbers.

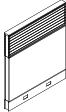
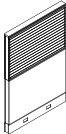
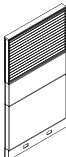
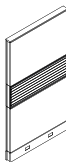
	DESCRIPTION	PRODUCT CODE	LIST PRICE		DIMENSIONS/INCHES		
			Gr1	Gr2	H	W	D
	Slatwall Panel - Double Sided - 42” High	EVPF2S4218	588	605	42	18	2 7/8
		EVPF2S4224	710	734	42	24	2 7/8
		EVPF2S4230	835	863	42	30	2 7/8
		EVPF2S4236	974	1005	42	36	2 7/8
		EVPF2S4242	1111	1144	42	42	2 7/8
		EVPF2S4248	1243	1281	42	48	2 7/8
		EVPF2S4254	1369	1408	42	54	2 7/8
		EVPF2S4260	1488	1537	42	60	2 7/8
	Slatwall Panel - Double Sided - 54” High	EVPF2S5418	686	704	54	18	2 7/8
		EVPF2S5424	840	866	54	24	2 7/8
		EVPF2S5430	992	1019	54	30	2 7/8
		EVPF2S5436	1158	1188	54	36	2 7/8
		EVPF2S5442	1325	1358	54	42	2 7/8
		EVPF2S5448	1487	1525	54	48	2 7/8
		EVPF2S5454	1636	1677	54	54	2 7/8
		EVPF2S5460	1781	1829	54	60	2 7/8
	Slatwall Panel - Double Sided - 66” High	EVPF2S6618	889	914	66	18	2 7/8
		EVPF2S6624	1094	1125	66	24	2 7/8
		EVPF2S6630	1295	1333	66	30	2 7/8
		EVPF2S6636	1503	1546	66	36	2 7/8
		EVPF2S6642	1721	1771	66	42	2 7/8
		EVPF2S6648	1930	1985	66	48	2 7/8
		EVPF2S6654	2131	2189	66	54	2 7/8
		EVPF2S6660	2325	2394	66	60	2 7/8
	Slatwall Panel - Double Sided - Middle Module - 66” High	EVPF2S6618M	866	897	66	18	2 7/8
		EVPF2S6624M	1063	1106	66	24	2 7/8
		EVPF2S6630M	1260	1309	66	30	2 7/8
		EVPF2S6636M	1463	1517	66	36	2 7/8
		EVPF2S6642M	1671	1733	66	42	2 7/8
		EVPF2S6648M	1873	1948	66	48	2 7/8
		EVPF2S6654M	2072	2149	66	54	2 7/8
		EVPF2S6660M	2263	2350	66	60	2 7/8

EVPLF2S - SLATWALL LIGHT PANEL - DOUBLE SIDED

- Slatwall Light Panel incorporates fabric modules with a single 12”H or 24”H top position slatwall module, into a solid steel frame.
- 66”H panel can be configured with either a 24”H slatwall module at the top or a 12”H slatwall at the middle Position (EVPLF2S66xxM)
- Slatwall module has slatwall on both sides.
- Slatwall is made of aluminum.
- Accessories can be used on slatwall modules. Please see accessory section for additional details.
- There is no base raceway in Light Panels to accommodate electrical.
- Light Panel Connectors must be used in conjunction with Light Panels.
- Opposite sides of each panel may have a different fabric within the same grade at no upcharge.
- If different grades of fabric are used on one panel, the entire panel must be priced at highest grade.
- An aluminum low profile top cap is included.
- Stackability: Evolve panels can be increased in height in 6”H, 12”H, 18”H or 24”H increments.
- See Extension Module (pages 82-90) for part numbers.

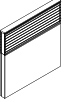
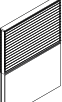
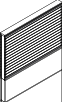
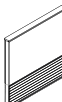
	DESCRIPTION	PRODUCT CODE	LIST PRICE		DIMENSIONS/INCHES		
			Gr1	Gr2	H	W	D
	Slatwall Light Panel - Double Sided - 42" High	EVPLF2S4218	576	592	42	18	2 7/8
		EVPLF2S4224	696	715	42	24	2 7/8
		EVPLF2S4230	821	842	42	30	2 7/8
		EVPLF2S4236	956	983	42	36	2 7/8
		EVPLF2S4242	1088	1120	42	42	2 7/8
		EVPLF2S4248	1219	1253	42	48	2 7/8
		EVPLF2S4254	1341	1378	42	54	2 7/8
	EVPLF2S4260	1457	1503	42	60	2 7/8	
	Slatwall Light Panel - Double Sided - 54" High	EVPLF2S5418	674	686	54	18	2 7/8
		EVPLF2S5424	827	844	54	24	2 7/8
		EVPLF2S5430	974	999	54	30	2 7/8
		EVPLF2S5436	1135	1161	54	36	2 7/8
		EVPLF2S5442	1296	1328	54	42	2 7/8
		EVPLF2S5448	1456	1490	54	48	2 7/8
		EVPLF2S5454	1604	1639	54	54	2 7/8
	EVPLF2S5460	1746	1790	54	60	2 7/8	
	Slatwall Light Panel - Double Sided - 66" High	EVPLF2S6618	872	896	66	18	2 7/8
		EVPLF2S6624	1072	1103	66	24	2 7/8
		EVPLF2S6630	1272	1306	66	30	2 7/8
		EVPLF2S6636	1473	1514	66	36	2 7/8
		EVPLF2S6642	1687	1732	66	42	2 7/8
		EVPLF2S6648	1892	1940	66	48	2 7/8
		EVPLF2S6654	2086	2143	66	54	2 7/8
	EVPLF2S6660	2280	2343	66	60	2 7/8	
	Slatwall Light Panel - Double Sided - 66" High	EVPLF2S6618M	840	878	66	18	2 7/8
		EVPLF2S6624M	1042	1081	66	24	2 7/8
		EVPLF2S6630M	1235	1281	66	30	2 7/8
		EVPLF2S6636M	1433	1484	66	36	2 7/8
		EVPLF2S6642M	1638	1699	66	42	2 7/8
		EVPLF2S6648M	1835	1903	66	48	2 7/8
		EVPLF2S6654M	2030	2105	66	54	2 7/8
	EVPLF2S6660M	2219	2304	66	60	2 7/8	



EVPBSFA - FRAMELESS SLATWALL BELTLINE POWERED PANEL - DOUBLE SIDED ONLY

- Frameless Slatwall Beltline Powered Panel incorporates fabric modules with a single 6”H slatwall module above a power beltline raceway, into a solid steel frame.
- Slatwall module has slatwall on both sides only, and is not available Single Sided.
- Slatwall is made of aluminum.
- Slatwall is not encompassed within a frame.
- A Chimney Panel is required to run electric and data from the base to belt
- 6”H power beltline raceway, to accommodate electrical, is metal with knockouts on both sides.
- Beltline Connectors must be used in conjunction with beltline panels.
- Accessories can be used on slatwall modules. Please see accessory section for additional details.
- Opposite sides of each panel may have a different fabric within the same grade at no upcharge.
- If different grades of fabric are used on one panel, the entire panel must be priced at highest grade.
- An aluminum low profile top cap is included.
- Stackability: Evolve panels can be increased in height in 6”H, 12”H, 18”H or 24”H increments. See Extension Module (pages 82-90) for part numbers.

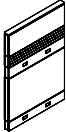
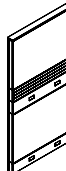
	DESCRIPTION	PRODUCT CODE	LIST PRICE		DIMENSIONS/INCHES		
			Gr1	Gr2	H	W	D
	Frameless Slatwall Beltline Powered Panel - Double Sided Only - 42” High	EVPBSFA4224	520	541	42	24	2 7/8
		EVPBSFA4230	605	627	42	30	2 7/8
		EVPBSFA4236	706	732	42	36	2 7/8
		EVPBSFA4242	794	824	42	42	2 7/8
		EVPBSFA4248	874	938	42	48	2 7/8
		EVPBSFA4254	961	1001	42	54	2 7/8
		EVPBSFA4260	1044	1088	42	60	2 7/8
	Frameless Slatwall Beltline Powered Panel - Double Sided Only - 54” High	EVPBSFA5424	657	686	54	24	2 7/8
		EVPBSFA5430	765	799	54	30	2 7/8
		EVPBSFA5436	902	941	54	36	2 7/8
		EVPBSFA5442	1009	1055	54	42	2 7/8
		EVPBSFA5448	1111	1163	54	48	2 7/8
		EVPBSFA5454	1207	1265	54	54	2 7/8
		EVPBSFA5460	1314	1379	54	60	2 7/8
	Frameless Slatwall Beltline Powered Panel - Double Sided Only - 66” High	EVPBSFA6624	733	769	66	24	2 7/8
		EVPBSFA6630	849	897	66	30	2 7/8
		EVPBSFA6636	981	1034	66	36	2 7/8
		EVPBSFA6642	1102	1162	66	42	2 7/8
		EVPBSFA6648	1216	1286	66	48	2 7/8
		EVPBSFA6654	1333	1408	66	54	2 7/8
		EVPBSFA6660	1448	1533	66	60	2 7/8

EVPBLSFA - FRAMELESS SLATWALL BELTLINE POWERED LIGHT PANEL - DOUBLE SIDED ONLY

- Frameless Slatwall Beltline Powered Light Panel incorporates fabric modules with a single 6”H slatwall module above a power beltline raceway, into a solid steel frame.
- Slatwall module has slatwall on both sides only, and is not available Single Sided.
- Slatwall is made of aluminum.
- Slatwall is not encompassed within a frame.
- 6”H power beltline raceway, to accommodate electrical, is metal with knockouts on both sides.
- There is no base raceway in Light Panels to accommodate electrical.
- Light Beltline Panel Connectors must be used in conjunction with Light Beltline Panels.
- Accessories can be used on slatwall modules. Please see accessory section for additional details.
- Opposite sides of each panel may have a different fabric within the same grade at no upcharge.
- If different grades of fabric are used on one panel, the entire panel must be priced at highest grade.
- An aluminum low profile top cap is included.
- Stackability: Evolve panels can be increased in height in 6”H, 12”H, 18”H or 24”H increments. See Extension Module (pages 82-90) for part numbers.

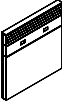
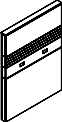
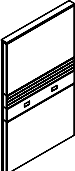
	DESCRIPTION	PRODUCT CODE	LIST PRICE		DIMENSIONS/INCHES		
			Gr1	Gr2	H	W	D
	Frameless Slatwall Beltline Powered Light Panel - Double Sided Only- 42” High	EVPBLSFA4224	497	514	42	24	2 7/8
		EVPBLSFA4230	576	598	42	30	2 7/8
		EVPBLSFA4236	674	699	42	36	2 7/8
		EVPBLSFA4242	753	785	42	42	2 7/8
		EVPBLSFA4248	834	869	42	48	2 7/8
		EVPBLSFA4254	919	957	42	54	2 7/8
	Frameless Slatwall Beltline Powered Light Panel - Double Sided Only- 54” High	EVPBLSFA5424	611	641	54	24	2 7/8
		EVPBLSFA5430	667	744	54	30	2 7/8
		EVPBLSFA5436	796	880	54	36	2 7/8
		EVPBLSFA5442	940	984	54	42	2 7/8
		EVPBLSFA5448	1034	1088	54	48	2 7/8
		EVPBLSFA5454	1122	1182	54	54	2 7/8
	Frameless Slatwall Beltline Powered Light Panel - Double Sided Only - 66” High	EVPBLSFA6624	678	714	66	24	2 7/8
		EVPBLSFA6630	784	831	66	30	2 7/8
		EVPBLSFA6636	910	963	66	36	2 7/8
		EVPBLSFA6642	1018	1081	66	42	2 7/8
		EVPBLSFA6648	1124	1194	66	48	2 7/8
		EVPBLSFA6654	1234	1308	66	54	2 7/8
		EVPBLSFA6660	1341	1426	66	60	2 7/8



EVPBCSFA - FRAMELESS SLATWALL BELTLINE POWERED CHIMNEY PANEL - DOUBLE SIDED ONLY

- Frameless Slatwall Beltline Powered Chimney Panel incorporates fabric modules with a single 6”H slatwall module above a power beltline raceway, into a solid steel frame.
- Slatwall module has slatwall on both sides only, and is not available Single Sided.
- Slatwall is made of aluminum.
- Slatwall is not encompassed within a frame.
- A Chimney Panel is required to run electric and data from the base to belt.
- Separate electric harness required to go from base to belt (see EVE8CPCP).
- 6”H power beltline raceway, to accommodate electrical, is metal with knockouts on both sides.
- Beltline Connectors must be used in conjunction with beltline panels.
- Accessories can be used on slatwall modules. Please see accessory section for additional details.
- Opposite sides of each panel may have a different fabric within the same grade at no upcharge.
- If different grades of fabric are used on one panel, the entire panel must be priced at highest grade.
- An aluminum low profile top cap is included.
- Stackability: Evolve panels can be increased in height in 6”H, 12”H, 18”H or 24”H increments. See Extension Module (pages 82-90) for part numbers.

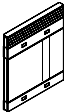
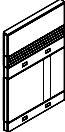
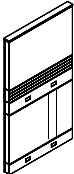
	DESCRIPTION	PRODUCT CODE	LIST PRICE		DIMENSIONS/INCHES		
			Gr1	Gr2	H	W	D
	Frameless Slatwall Beltline Powered -	EVPBCSFA4236	780	808	42	36	2 7/8
	Chimney Panel - Double Sided Only - 42” High	EVPBCSFA4242	868	901	42	42	2 7/8
	Frameless Slatwall Beltline Powered -	EVPBCSFA5436	978	1018	54	36	2 7/8
	Chimney Panel - Double Sided Only - 54” High	EVPBCSFA5442	1085	1130	54	42	2 7/8
	Frameless Slatwall Beltline Powered -	EVPBCSFA6636	1059	1111	66	36	2 7/8
	Chimney Panel - Double Sided Only - 66” High	EVPBCSFA6642	1176	1240	66	42	2 7/8

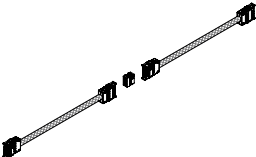

EVE8CPCP - CHIMNEY PANEL JUMPER CABLE KIT

- Contains two (2) 17” flexible harnesses and one (1) “I” connector.
- Used to connect electric from the base to the beltline raceway in Beltline Powered Chimney panel.
- Must use in conjunction with base power distribution harness and beltline power distribution harness (sold separately)

	DESCRIPTION	PRODUCT CODE	LIST PRICE	DIMENSIONS/INCHES		
				H	W	D
	Chimney Panel Jumper Cable Kit	EVE8CPCP	341			



EVPF1W - WRITE BOARD PANEL - SINGLE SIDED

- Write Board Panel incorporates fabric modules with a single 24”H top position write board module, into a solid steel frame.
- Use erasable writeboard markers only.
- Fabric covered modules are tackable and acoustical.
- Opposite sides of each panel may have a different fabric within the same grade at no upcharge.
- If different grades of fabric are used on one panel, the entire panel must be priced at highest grade.
- An aluminum low profile top cap is included.
- Stackability: Evolve panels can be increased in height in 6”H, 12”H, 18”H or 24”H increments. See Extension Module (pages 82-90) for part numbers.

	DESCRIPTION	PRODUCT CODE	LIST PRICE		DIMENSIONS/INCHES		
			Gr1	Gr2	H	W	D
	Write Board Panel - Single Sided - 54” High	EVPF1W5418	512	530	54	18	2 7/8
		EVPF1W5424	634	665	54	24	2 7/8
		EVPF1W5430	766	802	54	30	2 7/8
		EVPF1W5436	847	890	54	36	2 7/8
		EVPF1W5442	954	1004	54	42	2 7/8
		EVPF1W5448	1074	1129	54	48	2 7/8
		EVPF1W5454	1194	1237	54	54	2 7/8
		EVPF1W5460	1315	1381	54	60	2 7/8
	Write Board Panel - Single Sided - 66” High	EVPF1W6618	649	676	66	18	2 7/8
		EVPF1W6624	800	839	66	24	2 7/8
		EVPF1W6630	950	996	66	30	2 7/8
		EVPF1W6636	1058	1113	66	36	2 7/8
		EVPF1W6642	1195	1260	66	42	2 7/8
		EVPF1W6648	1335	1408	66	48	2 7/8
		EVPF1W6654	1484	1569	66	54	2 7/8
		EVPF1W6660	1637	1727	66	60	2 7/8

EVPLF1W - WRITE BOARD LIGHT PANEL - SINGLE SIDED



- Write Board Panel incorporates fabric modules with a single 24”H top position write board module, into a solid steel frame.
- Use erasable writeboard markers only.
- Fabric covered modules are tackable and acoustical.
- Opposite sides of each panel may have a different fabric within the same grade at no upcharge.
- If different grades of fabric are used on one panel, the entire panel must be priced at highest grade.
- Light panel connectors must be used for Light Panels.
- There is no base raceway in Light Panels to accommodate electrical.
- An aluminum low profile top cap is included.
- Stackability: Evolve panels can be increased in height in 6”H, 12”H, 18”H or 24”H increments. See Extension Module (pages 82-90) for part numbers.

	DESCRIPTION	PRODUCT CODE	LIST PRICE		DIMENSIONS/INCHES		
			Gr1	Gr2	H	W	D
	Write Board Light Panel - Single Sided - 54” High	EVPLF1W5418	497	512	54	18	2 7/8
		EVPLF1W5424	615	645	54	18	2 7/8
		EVPLF1W5430	743	775	54	18	2 7/8
		EVPLF1W5436	822	862	54	18	2 7/8
		EVPLF1W5442	923	971	54	18	2 7/8
		EVPLF1W5448	1042	1094	54	18	2 7/8
		EVPLF1W5454	1160	1195	54	18	2 7/8
		EVPLF1W5460	1276	1337	54	18	2 7/8
	Write Board Light Panel - Single Sided - 66” High	EVPLF1W6618	632	653	66	18	2 7/8
		EVPLF1W6624	775	811	66	24	2 7/8
		EVPLF1W6630	920	963	66	30	2 7/8
		EVPLF1W6636	1022	1077	66	36	2 7/8
		EVPLF1W6642	1161	1220	66	42	2 7/8
		EVPLF1W6648	1294	1363	66	48	2 7/8
		EVPLF1W6654	1437	1518	66	54	2 7/8
		EVPLF1W6660	1587	1671	66	60	2 7/8





EVPF2W - WRITE BOARD PANEL - DOUBLE SIDED

- Write Board Panel incorporates fabric modules with a single 24”H top position write board module, into a solid steel frame.
- Use erasable writeboard markers only.
- Opposite sides of each panel may have a different fabric within the same grade at no upcharge.
- If different grades of fabric are used on one panel, the entire panel must be priced at highest grade.
- An aluminum low profile top cap is included.
- Stackability: Evolve panels can be increased in height in 6”H, 12”H, 18”H or 24”H increments. See Extension Module (pages 82-90) for part numbers.

	DESCRIPTION	PRODUCT CODE	LIST PRICE		DIMENSIONS/INCHES		
			Gr1	Gr2	H	W	D
	Write Board Panel - Double Sided - 54” High	EVPF2W5418	554	570	54	18	2 7/8
		EVPF2W5424	693	712	54	24	2 7/8
		EVPF2W5430	864	889	54	30	2 7/8
		EVPF2W5436	932	963	54	36	2 7/8
		EVPF2W5442	1059	1092	54	42	2 7/8
		EVPF2W5448	1239	1275	54	48	2 7/8
		EVPF2W5454	1375	1416	54	54	2 7/8
		EVPF2W5460	1515	1564	54	60	2 7/8
	Write Board Panel - Double Sided - 66” High	EVPF2W6618	687	713	66	18	2 7/8
		EVPF2W6624	857	886	66	24	2 7/8
		EVPF2W6630	1048	1084	66	30	2 7/8
		EVPF2W6636	1146	1190	66	36	2 7/8
		EVPF2W6642	1297	1346	66	42	2 7/8
		EVPF2W6648	1493	1546	66	48	2 7/8
		EVPF2W6654	1666	1727	66	54	2 7/8
		EVPF2W6660	1835	1903	66	60	2 7/8

EVPLF2W - WRITE BOARD LIGHT PANEL - DOUBLE SIDED

- Write Board Light Panel incorporates fabric modules with a single 24”H top position write board module, into a solid steel frame.
- Use erasable writeboard markers only.
- There is no base raceway in Light Panels to accommodate electrical.
- Light Panel Connectors must be used in conjunction with Light Panels.
- Opposite sides of each panel may have a different fabric within the same grade at no upcharge.
- If different grades of fabric are used on one panel, the entire panel must be priced at highest grade.
- An aluminum low profile top cap is included.
- Stackability: Evolve panels can be increased in height in 6”H, 12”H, 18”H or 24”H increments. See Extension Module (pages 82-90) for part numbers.

	DESCRIPTION	PRODUCT CODE	LIST PRICE		DIMENSIONS/INCHES		
			Gr1	Gr2	H	W	D
	Write Board Light Panel - Double Sided - 54” High	EVPLF2W5418	537	548	54	18	2 7/8
		EVPLF2W5424	673	687	54	18	2 7/8
		EVPLF2W5430	835	861	54	18	2 7/8
		EVPLF2W5436	908	932	54	18	2 7/8
		EVPLF2W5442	1026	1059	54	18	2 7/8
		EVPLF2W5448	1199	1234	54	18	2 7/8
		EVPLF2W5454	1334	1372	54	18	2 7/8
		EVPLF2W5460	1470	1514	54	18	2 7/8
	Write Board Light Panel - Double Sided - 66” High	EVPLF2W6618	668	687	66	18	2 7/8
		EVPLF2W6624	830	861	66	24	2 7/8
		EVPLF2W6630	1015	1052	66	30	2 7/8
		EVPLF2W6636	1113	1153	66	36	2 7/8
		EVPLF2W6642	1260	1307	66	42	2 7/8
		EVPLF2W6648	1448	1496	66	48	2 7/8
		EVPLF2W6654	1616	1671	66	54	2 7/8
		EVPLF2W6660	1843	1843	66	60	2 7/8

EVPH1S - LAMINATE PANEL - SINGLE SIDED

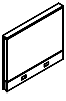
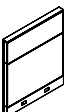
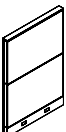
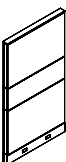

- Laminate Panel incorporates single sided laminate modules, into a solid steel frame.
- Opposite side is fabric covered.
- Laminate faces on all modules provide durable, washable surfaces on Single Sided of the panel.
- Available in high pressure laminate only.
- If wood grain is selected, grain runs horizontally.
- If different grades of fabric are used on one panel, the entire panel must be priced at highest grade.
- An aluminum low profile top cap is included.
- Stackability: Evolve panels can be increased in height in 6”H, 12”H, 18”H or 24”H increments. See Extension Module (pages 82-90) for part numbers.

	DESCRIPTION	PRODUCT CODE	LIST PRICE		DIMENSIONS/INCHES		
			Gr1	Gr2	H	W	D
	Laminate Panel - Single Sided - 30” High	EVPH1S3018	422	432	30	18	2 7/8
		EVPH1S3024	504	517	30	24	2 7/8
		EVPH1S3030	587	602	30	30	2 7/8
		EVPH1S3036	668	685	30	36	2 7/8
		EVPH1S3042	761	776	30	42	2 7/8
		EVPH1S3048	827	843	30	48	2 7/8
		EVPH1S3054	910	931	30	54	2 7/8
		EVPH1S3060	1000	1021	30	60	2 7/8
	Laminate Panel - Single Sided - 42” High	EVPH1S4218	502	515	42	18	2 7/8
		EVPH1S4224	597	614	42	24	2 7/8
		EVPH1S4230	699	718	42	30	2 7/8
		EVPH1S4236	800	826	42	36	2 7/8
		EVPH1S4242	908	933	42	42	2 7/8
		EVPH1S4248	986	1015	42	48	2 7/8
		EVPH1S4254	1094	1125	42	54	2 7/8
		EVPH1S4260	1199	1235	42	60	2 7/8
	Laminate Panel - Single Sided - 54” High	EVPH1S5418	588	602	54	18	2 7/8
		EVPH1S5424	708	733	54	24	2 7/8
		EVPH1S5430	830	857	54	30	2 7/8
		EVPH1S5436	951	978	54	36	2 7/8
		EVPH1S5442	1077	1112	54	42	2 7/8
		EVPH1S5448	1175	1213	54	48	2 7/8
		EVPH1S5454	1307	1346	54	54	2 7/8
		EVPH1S5460	1435	1482	54	60	2 7/8
	Laminate Panel - Single Sided - 66” High	EVPH1S6618	728	749	66	18	2 7/8
		EVPH1S6624	874	903	66	24	2 7/8
		EVPH1S6630	1021	1054	66	30	2 7/8
		EVPH1S6636	1179	1217	66	36	2 7/8
		EVPH1S6642	1340	1381	66	42	2 7/8
		EVPH1S6648	1457	1504	66	48	2 7/8
		EVPH1S6654	1624	1674	66	54	2 7/8
		EVPH1S6660	1786	1843	66	60	2 7/8





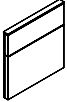
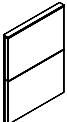

EVPLH1S - LAMINATE LIGHT PANEL - SINGLE SIDED

- Laminate Panel incorporates single sided laminate modules, into a solid steel frame.
- Opposite side is fabric covered.
- Laminate faces on all modules provide durable, washable surfaces on Single Sided of the panel.
- Available in high pressure laminate only.
- If wood grain is selected, grain runs horizontally.
- There is no base raceway in Light Panels to accommodate electrical.
- Light Panel Connectors must be used in conjunction with Light Panels.
- If different grades of fabric are used on one panel, the entire panel must be priced at highest grade.
- An aluminum low profile top cap is included.
- Stackability: Evolve panels can be increased in height in 6”H, 12”H, 18”H or 24”H increments. See Extension Module (pages 82-90) for part numbers.

	DESCRIPTION	PRODUCT CODE	LIST PRICE		DIMENSIONS/INCHES		
			Gr1	Gr2	H	W	D
	Laminate Light Panel - Single Sided - 30" High	EVPLH1S3018	411	418	30	18	2 7/8
		EVPLH1S3024	491	501	30	24	2 7/8
		EVPLH1S3030	570	578	30	30	2 7/8
		EVPLH1S3036	648	665	30	36	2 7/8
		EVPLH1S3042	735	748	30	42	2 7/8
		EVPLH1S3048	801	814	30	48	2 7/8
		EVPLH1S3054	882	905	30	54	2 7/8
		EVPLH1S3060	968	987	30	60	2 7/8
	Laminate Light Panel - Single Sided - 42" High	EVPLH1S4218	488	497	42	18	2 7/8
		EVPLH1S4224	577	594	42	24	2 7/8
		EVPLH1S4230	677	697	42	30	2 7/8
		EVPLH1S4236	775	799	42	36	2 7/8
		EVPLH1S4242	879	905	42	42	2 7/8
		EVPLH1S4248	959	982	42	48	2 7/8
		EVPLH1S4254	1062	1092	42	54	2 7/8
		EVPLH1S4260	1163	1195	42	60	2 7/8
	Laminate Light Panel - Single Sided - 54" High	EVPLH1S5418	571	578	54	18	2 7/8
		EVPLH1S5424	686	707	54	24	2 7/8
		EVPLH1S5430	807	828	54	30	2 7/8
		EVPLH1S5436	921	950	54	36	2 7/8
		EVPLH1S5442	1044	1074	54	42	2 7/8
		EVPLH1S5448	1139	1174	54	48	2 7/8
		EVPLH1S5454	1267	1306	54	54	2 7/8
		EVPLH1S5460	1392	1434	54	60	2 7/8
	Laminate Light Panel - Single Sided - 66" High	EVPLH1S6618	706	725	66	18	2 7/8
		EVPLH1S6624	849	872	66	24	2 7/8
		EVPLH1S6630	989	1020	66	30	2 7/8
		EVPLH1S6636	1142	1176	66	36	2 7/8
		EVPLH1S6642	1297	1336	66	42	2 7/8
		EVPLH1S6648	1416	1456	66	48	2 7/8
		EVPLH1S6654	1573	1624	66	54	2 7/8
		EVPLH1S6660	1732	1786	66	60	2 7/8

EVPH2S - LAMINATE PANEL - DOUBLE SIDED





- Laminate Panel incorporates double sided laminate modules, into a solid steel frame.
- Laminate faces on all modules provide durable, washable surfaces on Single Sided of the panel.
- Available in high pressure laminate only.
- If wood grain is selected, grain runs horizontally.
- If different grades of fabric are used on one panel, the entire panel must be priced at highest grade.
- An aluminum low profile top cap is included.
- Stackability: Evolve panels can be increased in height in 6”H, 12”H, 18”H or 24”H increments. See Extension Module (pages 82-90) for part numbers.

	DESCRIPTION	PRODUCT CODE	LIST PRICE	DIMENSIONS/INCHES		
				H	W	D
	Laminate Panel - Double Sided - 30" High	EVPH2S3018	575	30	18	2 7/8
		EVPH2S3024	575	30	24	2 7/8
		EVPH2S3030	678	30	30	2 7/8
		EVPH2S3036	775	30	36	2 7/8
		EVPH2S3042	882	30	42	2 7/8
		EVPH2S3048	984	30	48	2 7/8
		EVPH2S3054	1092	30	54	2 7/8
	EVPH2S3060	1179	30	60	2 7/8	
	Laminate Panel - Double Sided - 42" High	EVPH2S4218	558	42	18	2 7/8
		EVPH2S4224	678	42	24	2 7/8
		EVPH2S4230	799	42	30	2 7/8
		EVPH2S4236	929	42	36	2 7/8
		EVPH2S4242	1059	42	42	2 7/8
		EVPH2S4248	1185	42	48	2 7/8
		EVPH2S4254	1304	42	54	2 7/8
	EVPH2S4260	1417	42	60	2 7/8	
	Laminate Panel - Double Sided - 54" High	EVPH2S5418	655	54	18	2 7/8
		EVPH2S5424	801	54	24	2 7/8
		EVPH2S5430	950	54	30	2 7/8
		EVPH2S5436	1103	54	36	2 7/8
		EVPH2S5442	1259	54	42	2 7/8
		EVPH2S5448	1416	54	48	2 7/8
		EVPH2S5454	1560	54	54	2 7/8
	EVPH2S5460	1697	54	60	2 7/8	
	Laminate Panel - Double Sided - 66" High	EVPH2S6618	827	66	18	2 7/8
		EVPH2S6624	1014	66	24	2 7/8
		EVPH2S6630	1199	66	30	2 7/8
		EVPH2S6636	1392	66	36	2 7/8
		EVPH2S6642	1593	66	42	2 7/8
		EVPH2S6648	1786	66	48	2 7/8
		EVPH2S6654	1971	66	54	2 7/8
	EVPH2S6660	2153	66	60	2 7/8	





EVPLH2S - LAMINATE LIGHT PANEL - DOUBLE SIDED

- Laminate Panel incorporates double sided laminate modules, into a solid steel frame.
- Laminate faces on all modules provide durable, washable surfaces on Single Sided of the panel.
- Available in high pressure laminate only
- If wood grain is selected, grain runs horizontally.
- There is no base raceway in Light Panels to accommodate electrical.
- Light Panel Connectors must be used in conjunction with Light Panels.
- If different grades of fabric are used on one panel, the entire panel must be priced at highest grade.
- An aluminum low profile top cap is included.
- Stackability: Evolve panels can be increased in height in 6”H, 12”H, 18”H or 24”H increments. See Extension Module (pages 82-90) for part numbers.

	DESCRIPTION	PRODUCT CODE	LIST PRICE	DIMENSIONS/INCHES		
				H	W	D
	Laminate Light Panel - Double Sided - 30" High	EVPLH2S3018	557	30	18	2 7/8
		EVPLH2S3024	557	30	24	2 7/8
		EVPLH2S3030	657	30	30	2 7/8
		EVPLH2S3036	751	30	36	2 7/8
		EVPLH2S3042	858	30	42	2 7/8
		EVPLH2S3048	957	30	48	2 7/8
		EVPLH2S3054	1060	30	54	2 7/8
		EVPLH2S3060	1142	30	60	2 7/8
	Laminate Light Panel - Double Sided - 42" High	EVPLH2S4218	543	42	18	2 7/8
		EVPLH2S4224	657	42	24	2 7/8
		EVPLH2S4230	774	42	30	2 7/8
		EVPLH2S4236	902	42	36	2 7/8
		EVPLH2S4242	1026	42	42	2 7/8
		EVPLH2S4248	1152	42	48	2 7/8
		EVPLH2S4254	1263	42	54	2 7/8
		EVPLH2S4260	1375	42	60	2 7/8
	Laminate Light Panel - Double Sided - 54" High	EVPLH2S5418	635	54	18	2 7/8
		EVPLH2S5424	776	54	24	2 7/8
		EVPLH2S5430	920	54	30	2 7/8
		EVPLH2S5436	1069	54	36	2 7/8
		EVPLH2S5442	1220	54	42	2 7/8
		EVPLH2S5448	1374	54	48	2 7/8
		EVPLH2S5454	1513	54	54	2 7/8
		EVPLH2S5460	1643	54	60	2 7/8
	Laminate Light Panel - Double Sided - 66" High	EVPLH2S6618	706	66	18	2 7/8
		EVPLH2S6624	982	66	24	2 7/8
		EVPLH2S6630	1163	66	30	2 7/8
		EVPLH2S6636	1349	66	36	2 7/8
		EVPLH2S6642	1544	66	42	2 7/8
		EVPLH2S6648	1732	66	48	2 7/8
		EVPLH2S6654	1912	66	54	2 7/8
		EVPLH2S6660	2088	66	60	2 7/8

EVPFAF - AIRFLOW PANEL

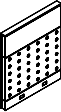
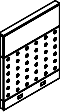
- Airflow Panel incorporates bottom 24”H airflow module with individual fabric modules, within a steel frame.
- The 24”H Metal airflow module is positioned in the base section to provide air circulation.
- Opposite sides of each panel may have a different fabric within the same grade at no upcharge.
- If different grades of fabric are used on one panel, the entire panel must be priced at highest grade.
- An aluminum low profile top cap is included.
- Stackability: Evolve panels can be increased in height in 6”H, 12”H, 18”H or 24”H increments. See Extension Module (pages 82-90) for part numbers.

	DESCRIPTION	PRODUCT CODE	LIST PRICE		DIMENSIONS/INCHES		
			Gr1	Gr2	H	W	D
	Airflow Panel - 30” High	EVPFAF3024	483		30	24	2 7/8
		EVPFAF3030	574		30	30	2 7/8
		EVPFAF3036	635		30	36	2 7/8
		EVPFAF3042	706		30	42	2 7/8
		EVPFAF3048	796		30	48	2 7/8
		EVPFAF3054	912		30	54	2 7/8
		EVPFAF3060	1029		30	60	2 7/8
	Airflow Panel - 42” High	EVPFAF4224	615	625	42	24	2 7/8
		EVPFAF4230	728	743	42	30	2 7/8
		EVPFAF4236	810	827	42	36	2 7/8
		EVPFAF4242	900	917	42	42	2 7/8
		EVPFAF4248	1017	1035	42	48	2 7/8
		EVPFAF4254	1158	1179	42	54	2 7/8
		EVPFAF4260	1175	1199	42	60	2 7/8
	Airflow Panel - 54” High	EVPFAF5424	690	714	54	24	2 7/8
		EVPFAF5430	795	820	54	30	2 7/8
		EVPFAF5436	888	918	54	36	2 7/8
		EVPFAF5442	989	1024	54	42	2 7/8
		EVPFAF5448	1113	1152	54	48	2 7/8
		EVPFAF5454	1295	1339	54	54	2 7/8
		EVPFAF5460	1413	1459	54	60	2 7/8
	Airflow Panel - 66” High	EVPFAF6624	806	835	66	24	2 7/8
		EVPFAF6630	950	985	66	30	2 7/8
		EVPFAF6636	1063	1107	66	36	2 7/8
		EVPFAF6642	1185	1233	66	42	2 7/8
		EVPFAF6648	1335	1389	66	48	2 7/8
		EVPFAF6654	1509	1570	66	54	2 7/8
		EVPFAF6660	1679	1747	66	60	2 7/8



EVPLFAF - AIRFLOW LIGHT PANEL

- Airflow Light Panel incorporates bottom 24”H airflow module with individual fabric modules, within a steel frame.
- The 24”H Metal airflow module is positioned in the base section to provide air circulation.
- There is no base raceway in Light Panels to accommodate electrical.
- Light Panel Connectors must be used in conjunction with Light Panels.
- Opposite sides of each panel may have a different fabric within the same grade at no upcharge.
- If different grades of fabric are used on one panel, the entire panel must be priced at highest grade.
- An aluminum low profile top cap is included.
- Stackability: Evolve panels can be increased in height in 6”H, 12”H, 18”H or 24”H increments. See Extension Module listings for part numbers

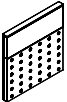
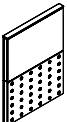
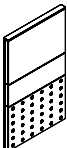
	DESCRIPTION	PRODUCT CODE	LIST PRICE		DIMENSIONS/INCHES		
			Gr1	Gr2	H	W	D
	Airflow Light Panel - 30” High	EVPLFAF3024	470		30	18	2 7/8
		EVPLFAF3030	556		30	30	2 7/8
		EVPLFAF3036	616		30	36	2 7/8
		EVPLFAF3042	684		30	42	2 7/8
		EVPLFAF3048	770		30	48	2 7/8
		EVPLFAF3054	886		30	54	2 7/8
		EVPLFAF3060	1001		30	60	2 7/8
	Airflow Light Panel - 42” High	EVPLFAF4224	598	605	42	18	2 7/8
		EVPLFAF4230	706	718	42	30	2 7/8
		EVPLFAF4236	785	801	42	36	2 7/8
		EVPLFAF4242	871	887	42	42	2 7/8
		EVPLFAF4248	984	1004	42	48	2 7/8
		EVPLFAF4254	1121	1141	42	54	2 7/8
		EVPLFAF4260	1139	1161	42	60	2 7/8
	Airflow Light Panel - 54” High	EVPLFAF5424	671	687	54	18	2 7/8
		EVPLFAF5430	769	795	54	30	2 7/8
		EVPLFAF5436	864	888	54	36	2 7/8
		EVPLFAF5442	961	992	54	42	2 7/8
		EVPLFAF5448	1078	1115	54	48	2 7/8
		EVPLFAF5454	1257	1293	54	54	2 7/8
		EVPLFAF5460	1371	1413	54	60	2 7/8
	Airflow Light Panel - 66” High	EVPLFAF6624	779	808	66	18	2 7/8
		EVPLFAF6630	920	956	66	30	2 7/8
		EVPLFAF6636	1032	1072	66	36	2 7/8
		EVPLFAF6642	1152	1194	66	42	2 7/8
		EVPLFAF6648	1294	1346	66	48	2 7/8
		EVPLFAF6654	1465	1518	66	54	2 7/8
		EVPLFAF6660	1630	1691	30	60	2 7/8

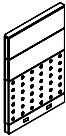
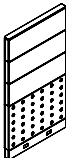

EVPPPAF - AIRFLOW PREMIUM PANEL

- Airflow Premium Panel incorporates bottom 24”H airflow module with individual fabric modules, within a steel frame.
- The 24”H Metal airflow module is positioned in the base section to provide air circulation.
- Premium panels incorporate 12”H acoustic modules above 30”H base section.
- Opposite sides of each panel may have a different fabric within the same grade at no upcharge.
- If different grades of fabric are used on one panel, the entire panel must be priced at highest grade.
- An aluminum low profile top cap is included.
- Stackability: Evolve panels can be increased in height in 6”H, 12”H, 18”H or 24”H increments. See Extension Module (pages 82-90) for part numbers.

	DESCRIPTION	PRODUCT CODE	LIST PRICE		DIMENSIONS/INCHES		
			Gr1	Gr2	H	W	D
	Airflow Premium Panel - 54” High	EVPPPAF5424	767	785	54	24	2 7/8
		EVPPPAF5430	878	905	54	30	2 7/8
		EVPPPAF5436	982	1011	54	36	2 7/8
		EVPPPAF5442	1091	1124	54	42	2 7/8
		EVPPPAF5448	1235	1273	54	48	2 7/8
		EVPPPAF5454	1396	1439	54	54	2 7/8
	Airflow Premium Panel - 66” High	EVPPPAF6624	879	910	66	24	2 7/8
		EVPPPAF6630	1032	1070	66	30	2 7/8
		EVPPPAF6636	1155	1198	66	36	2 7/8
		EVPPPAF6642	1282	1331	66	42	2 7/8
		EVPPPAF6648	1456	1513	66	48	2 7/8
		EVPPPAF6654	1639	1701	66	54	2 7/8
EVPPPAF6660	1829	1895	66	60	2 7/8		

EVPLPPAF - AIRFLOW PREMIUM LIGHT PANEL

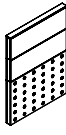



- Airflow Premium Light Panel incorporates bottom 24”H airflow module with individual 12”H fabric modules, within a steel frame.
- The 24”H Metal airflow module is positioned in the base section to provide air circulation.
- Premium panels incorporate 12”H acoustic modules above 30”H base section.
- There is no base raceway in Light Panels to accommodate electrical.
- Light Panel Connectors must be used in conjunction with Light Panels.
- Opposite sides of each panel may have a different fabric within the same grade at no upcharge.
- If different grades of fabric are used on one panel, the entire panel must be priced at highest grade.
- An aluminum low profile top cap is included.
- Stackability: Evolve panels can be increased in height in 6”H, 12”H, 18”H or 24”H increments. See Extension Module (pages 82-90) for part numbers.

	DESCRIPTION	PRODUCT CODE	LIST PRICE		DIMENSIONS/INCHES		
			Gr1	Gr2	H	W	D
	Airflow Premium Light Panel - 54” High	EVPLPPAF5424	744	764	54	18	2 7/8
		EVPLPPAF5430	854	874	54	30	2 7/8
		EVPLPPAF5436	954	978	54	36	2 7/8
		EVPLPPAF5442	1059	1088	54	42	2 7/8
		EVPLPPAF5448	1196	1231	54	48	2 7/8
		EVPLPPAF5454	1356	1391	54	54	2 7/8
	Airflow Premium Light Panel - 66” High	EVPLPPAF6624	855	880	66	18	2 7/8
		EVPLPPAF6630	1003	1034	66	30	2 7/8
		EVPLPPAF6636	1120	1161	66	36	2 7/8
		EVPLPPAF6642	1243	1287	66	42	2 7/8
		EVPLPPAF6648	1414	1466	66	48	2 7/8
		EVPLPPAF6654	1591	1643	66	54	2 7/8
EVPLPPAF6660	1773	1834	66	60	2 7/8		



EVPM1S - METAL SKIN PANEL - SINGLE SIDED



- Metal Skin Panel incorporates single sided metal skin modules, into a solid steel frame.
- Opposite side is fabric covered.
- Metal faces on all modules provide durable, washable and magnetic surfaces on Single Sided of the panel.
- If different grades of fabric are used on one panel, the entire panel must be priced at highest grade.
- An aluminum low profile top cap is included.
- Stackability: Evolve panels can be increased in height in 6”H, 12”H, 18”H or 24”H increments. See Extension Module (pages 82-90) for part numbers.

	DESCRIPTION	PRODUCT CODE	LIST PRICE		DIMENSIONS/INCHES		
			Gr1	Gr2	H	W	D
	Metal Skin Panel - Single Sided 30" High	EVPM1S3018	547	557	30	18	2 7/8
		EVPM1S3024	655	669	30	24	2 7/8
		EVPM1S3030	763	776	30	30	2 7/8
		EVPM1S3036	867	883	30	36	2 7/8
		EVPM1S3042	983	1002	30	42	2 7/8
		EVPM1S3048	1071	1090	30	48	2 7/8
		EVPM1S3054	1183	1202	30	54	2 7/8
		EVPM1S3060	1295	1319	30	60	2 7/8
	Metal Skin Panel - Single Sided 42" High	EVPM1S4218	649	662	42	18	2 7/8
		EVPM1S4224	773	788	42	24	2 7/8
		EVPM1S4230	908	926	42	30	2 7/8
		EVPM1S4236	1038	1065	42	36	2 7/8
		EVPM1S4242	1179	1205	42	42	2 7/8
		EVPM1S4248	1281	1310	42	48	2 7/8
		EVPM1S4254	1423	1452	42	54	2 7/8
		EVPM1S4260	1561	1594	42	60	2 7/8
	Metal Skin Panel - Single Sided 54" High	EVPM1S5418	765	780	54	18	2 7/8
		EVPM1S5424	920	939	54	24	2 7/8
		EVPM1S5430	1077	1103	54	30	2 7/8
		EVPM1S5436	1231	1261	54	36	2 7/8
		EVPM1S5442	1397	1432	54	42	2 7/8
		EVPM1S5448	1526	1565	54	48	2 7/8
		EVPM1S5454	1697	1741	54	54	2 7/8
		EVPM1S5460	1865	1909	54	60	2 7/8
	Metal Skin Panel - Single Sided 66" High	EVPM1S6618	942	966	66	18	2 7/8
		EVPM1S6624	1136	1163	66	24	2 7/8
		EVPM1S6630	1327	1358	66	30	2 7/8
		EVPM1S6636	1531	1569	66	36	2 7/8
		EVPM1S6642	1740	1781	66	42	2 7/8
		EVPM1S6648	1894	1941	66	48	2 7/8
		EVPM1S6654	2106	2157	66	54	2 7/8
		EVPM1S6660	2320	2377	66	60	2 7/8





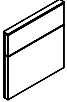
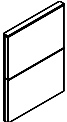

EVPLM1S - METAL SKIN LIGHT PANEL - SINGLE SIDED

- Metal Skin Light Panel incorporates single sided metal skin modules, into a solid steel frame.
- Opposite side is fabric covered.
- Metal faces on all modules provide durable, washable and magnetic surfaces on Single Sided of the panel.
- There is no base raceway in Light Panels to accommodate electrical.
- Light Panel Connectors must be used in conjunction with Light Panels.
- If different grades of fabric are used on one panel, the entire panel must be priced at highest grade.
- An aluminum low profile top cap is included.
- Stackability: Evolve panels can be increased in height in 6”H, 12”H, 18”H or 24”H increments. See Extension Module (pages 82-90) for part numbers.

	DESCRIPTION	PRODUCT CODE	LIST PRICE		DIMENSIONS/INCHES		
			Gr1	Gr2	H	W	D
	Metal Skin Light Panel - Single Sided - 30" High	EVPLM1S3018	533	541	30	18	2 7/8
		EVPLM1S3024	635	646	30	24	2 7/8
		EVPLM1S3030	736	747	30	30	2 7/8
		EVPLM1S3036	840	857	30	36	2 7/8
		EVPLM1S3042	956	970	30	42	2 7/8
		EVPLM1S3048	1038	1055	30	48	2 7/8
		EVPLM1S3054	1150	1164	30	54	2 7/8
		EVPLM1S3060	1257	1278	30	60	2 7/8
	Metal Skin Light Panel - Single Sided - 42" High	EVPLM1S4218	632	642	42	18	2 7/8
		EVPLM1S4224	748	765	42	24	2 7/8
		EVPLM1S4230	879	899	42	30	2 7/8
		EVPLM1S4236	1008	1028	42	36	2 7/8
		EVPLM1S4242	1142	1164	42	42	2 7/8
		EVPLM1S4248	1242	1270	42	48	2 7/8
		EVPLM1S4254	1378	1406	42	54	2 7/8
		EVPLM1S4260	1514	1544	42	60	2 7/8
	Metal Skin Light Panel - Single Sided - 54" High	EVPLM1S5418	739	753	54	18	2 7/8
		EVPLM1S5424	890	910	54	24	2 7/8
		EVPLM1S5430	1044	1066	54	30	2 7/8
		EVPLM1S5436	1194	1221	54	36	2 7/8
		EVPLM1S5442	1357	1388	54	42	2 7/8
		EVPLM1S5448	1481	1515	54	48	2 7/8
		EVPLM1S5454	1643	1687	54	54	2 7/8
		EVPLM1S5460	1808	1851	54	60	2 7/8
	Metal Skin Light Panel - Single Sided - 66" High	EVPLM1S6618	916	932	66	18	2 7/8
		EVPLM1S6624	1103	1124	66	24	2 7/8
		EVPLM1S6630	1286	1316	66	30	2 7/8
		EVPLM1S6636	1484	1520	66	36	2 7/8
		EVPLM1S6642	1688	1726	66	42	2 7/8
		EVPLM1S6648	1835	1879	66	48	2 7/8
		EVPLM1S6654	2044	2090	66	54	2 7/8
		EVPLM1S6660	2250	2305	66	60	2 7/8

EVPM2S - METAL SKIN PANEL - DOUBLE SIDED



- Metal Skin Panel incorporates double sided metal skin modules, into a solid steel frame.
- Metal faces on all modules provide durable, washable and magnetic surfaces on Single Sided of the panel.
- If different grades of fabric are used on one panel, the entire panel must be priced at highest grade.
- An aluminum low profile top cap is included.
- Stackability: Evolve panels can be increased in height in 6”H, 12”H, 18”H or 24”H increments. See Extension Module (pages 82-90) for part numbers.

	DESCRIPTION	PRODUCT CODE	LIST PRICE	DIMENSIONS/INCHES		
				H	W	D
	Metal Skin Panel - Double Sided - 30” High	EVPM2S3018	806	30	18	2 7/8
		EVPM2S3024	806	30	24	2 7/8
		EVPM2S3030	948	30	30	2 7/8
		EVPM2S3036	1085	30	36	2 7/8
		EVPM2S3042	1085	30	42	2 7/8
		EVPM2S3048	1231	30	48	2 7/8
		EVPM2S3054	1377	30	54	2 7/8
	EVPM2S3060	1645	30	60	2 7/8	
	Metal Skin Panel - Double Sided - 42” High	EVPM2S4218	779	42	18	2 7/8
		EVPM2S4224	948	42	24	2 7/8
		EVPM2S4230	1116	42	30	2 7/8
		EVPM2S4236	1297	42	36	2 7/8
		EVPM2S4242	1479	42	42	2 7/8
		EVPM2S4248	1659	42	48	2 7/8
		EVPM2S4254	1822	42	54	2 7/8
	EVPM2S4260	1983	42	60	2 7/8	
	Metal Skin Panel - Double Sided - 54” High	EVPM2S5418	916	54	18	2 7/8
		EVPM2S5424	1120	54	24	2 7/8
		EVPM2S5430	1326	54	30	2 7/8
		EVPM2S5436	1540	54	36	2 7/8
		EVPM2S5442	1762	54	42	2 7/8
		EVPM2S5448	1980	54	48	2 7/8
		EVPM2S5454	2178	54	54	2 7/8
	EVPM2S5460	2375	54	60	2 7/8	
	Metal Skin Panel - Double Sided - 66” High	EVPM2S6618	1153	66	18	2 7/8
		EVPM2S6624	1417	66	24	2 7/8
		EVPM2S6630	1678	66	30	2 7/8
		EVPM2S6636	1949	66	36	2 7/8
		EVPM2S6642	2227	66	42	2 7/8
		EVPM2S6648	2499	66	48	2 7/8
		EVPM2S6654	2756	66	54	2 7/8
	EVPM2S6660	3016	66	60	2 7/8	

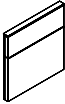
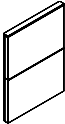

EVPLM2S - METAL SKIN LIGHT PANEL - DOUBLE SIDED

- Metal Skin Light Panel incorporates double sided metal skin modules, into a solid steel frame.
- Metal faces on all modules provide durable, washable and magnetic surfaces on Single Sided of the panel.
- There is no base raceway in Light Panels to accommodate electrical.
- Light Panel Connectors must be used in conjunction with Light Panels.
- If different grades of fabric are used on one panel, the entire panel must be priced at highest grade.
- An aluminum low profile top cap is included.
- Stackability: Evolve panels can be increased in height in 6”H, 12”H, 18”H or 24”H increments. See Extension Module (pages 82-90) for part numbers.

	DESCRIPTION	PRODUCT CODE	LIST PRICE	DIMENSIONS/INCHES		
				H	W	D
	Metal Skin Light Panel - Double Sided - 30" High	EVPLM2S3018	779	30	18	2 7/8
		EVPLM2S3024	779	30	24	2 7/8
		EVPLM2S3030	919	30	30	2 7/8
		EVPLM2S3036	1053	30	36	2 7/8
		EVPLM2S3042	1053	30	42	2 7/8
		EVPLM2S3048	1194	30	48	2 7/8
		EVPLM2S3054	1335	30	54	2 7/8
		EVPLM2S3060	1598	30	60	2 7/8
	Metal Skin Light Panel - Double Sided - 42" High	EVPLM2S4218	757	42	18	2 7/8
		EVPLM2S4224	919	42	24	2 7/8
		EVPLM2S4230	1081	42	30	2 7/8
		EVPLM2S4236	1260	42	36	2 7/8
		EVPLM2S4242	1433	42	42	2 7/8
		EVPLM2S4248	1608	42	48	2 7/8
		EVPLM2S4254	1768	42	54	2 7/8
		EVPLM2S4260	1923	42	60	2 7/8
	Metal Skin Light Panel - Double Sided - 54" High	EVPLM2S5418	887	54	18	2 7/8
		EVPLM2S5424	1087	54	24	2 7/8
		EVPLM2S5430	1285	54	30	2 7/8
		EVPLM2S5436	1494	54	36	2 7/8
		EVPLM2S5442	1709	54	42	2 7/8
		EVPLM2S5448	1920	54	48	2 7/8
		EVPLM2S5454	2111	54	54	2 7/8
		EVPLM2S5460	2304	54	60	2 7/8
	Metal Skin Light Panel - Double Sided - 66" High	EVPLM2S6618	1118	66	18	2 7/8
		EVPLM2S6624	1375	66	24	2 7/8
		EVPLM2S6630	1628	66	30	2 7/8
		EVPLM2S6636	1891	66	36	2 7/8
		EVPLM2S6642	2158	66	42	2 7/8
		EVPLM2S6648	2425	66	48	2 7/8
		EVPLM2S6654	2671	66	54	2 7/8
		EVPLM2S6660	2953	66	60	2 7/8

EVPFOL - OPEN BOTTOM PANEL

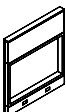
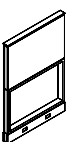
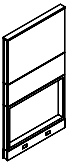

- Open Bottom Panel incorporates bottom 24”H open module with individual fabric modules, within a steel frame.
- The 24”H open bottom module in the base section is to provide air circulation and access to electrical or data.
- Opposite sides of each panel may have a different fabric within the same grade at no upcharge.
- If different grades of fabric are used on one panel, the entire panel must be priced at highest grade.
- An aluminum low profile top cap is included.
- Stackability: Evolve panels can be increased in height in 6”H, 12”H, 18”H or 24”H increments. See Extension Module (pages 82-90) for part numbers.

	DESCRIPTION	PRODUCT CODE	LIST PRICE		DIMENSIONS/INCHES		
			Gr1	Gr2	H	W	D
	Open Bottom Panel - 30" High	EVPFOL3018	279		30	18	2 7/8
		EVPFOL3024	317		30	24	2 7/8
		EVPFOL3030	358		30	30	2 7/8
		EVPFOL3036	393		30	36	2 7/8
		EVPFOL3042	431		30	42	2 7/8
		EVPFOL3048	465		30	48	2 7/8
		EVPFOL3054	503		30	54	2 7/8
EVPFOL3060	539		30	60	2 7/8		
	Open Bottom Panel - 42" High	EVPFOL4218	415	423	42	18	2 7/8
		EVPFOL4224	477	490	42	24	2 7/8
		EVPFOL4230	539	554	42	30	2 7/8
		EVPFOL4236	604	622	42	36	2 7/8
		EVPFOL4242	671	688	42	42	2 7/8
		EVPFOL4248	721	739	42	48	2 7/8
		EVPFOL4254	795	813	42	54	2 7/8
EVPFOL4260	862	883	42	60	2 7/8		
	Open Bottom Panel - 54" High	EVPFOL5418	469	486	54	18	2 7/8
		EVPFOL5424	534	558	54	24	2 7/8
		EVPFOL5430	612	636	54	30	2 7/8
		EVPFOL5436	685	716	54	36	2 7/8
		EVPFOL5442	764	797	54	42	2 7/8
		EVPFOL5448	827	865	54	48	2 7/8
		EVPFOL5454	905	941	54	54	2 7/8
EVPFOL5460	978	1026	54	60	2 7/8		
	Open Bottom Panel - 66" High	EVPFOL6618	608	634	66	18	2 7/8
		EVPFOL6624	699	730	66	24	2 7/8
		EVPFOL6630	799	835	66	30	2 7/8
		EVPFOL6636	897	938	66	36	2 7/8
		EVPFOL6642	1007	1058	66	42	2 7/8
		EVPFOL6648	1078	1132	66	48	2 7/8
		EVPFOL6654	1191	1250	66	54	2 7/8
EVPFOL6660	1297	1366	66	60	2 7/8		



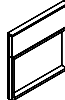

EVPLFOL - OPEN BOTTOM LIGHT PANEL

- Open Bottom Light Panel incorporates bottom 24”H open module with individual fabric modules, within a steel frame.
- The 24”H open bottom module in the base section is to provide air circulation and access to electrical or data.
- There is no base raceway in Light Panels to accommodate electrical.
- Light Panel Connectors must be used in conjunction with Light Panels.
- Opposite sides of each panel may have a different fabric within the same grade at no upcharge.
- If different grades of fabric are used on one panel, the entire panel must be priced at highest grade.
- An aluminum low profile top cap is included.
- Stackability: Evolve panels can be increased in height in 6”H, 12”H, 18”H or 24”H increments. See Extension Module (pages 82-90) for part numbers.

	DESCRIPTION	PRODUCT CODE	LIST PRICE		DIMENSIONS/INCHES		
			Gr1	Gr2	H	W	D
	Open Bottom Light Panel - 30” High	EVPLFOL3018	269		30	18	2 7/8
		EVPLFOL3024	304		30	24	2 7/8
		EVPLFOL3030	348		30	30	2 7/8
		EVPLFOL3036	382		30	36	2 7/8
		EVPLFOL3042	418		30	42	2 7/8
		EVPLFOL3048	445		30	48	2 7/8
		EVPLFOL3054	490		30	54	2 7/8
		EVPLFOL3060	523		30	60	2 7/8
	Open Bottom Light Panel - 42” High	EVPLFOL4218	401	409	42	18	2 7/8
		EVPLFOL4224	462	472	42	24	2 7/8
		EVPLFOL4230	523	535	42	30	2 7/8
		EVPLFOL4236	587	601	42	36	2 7/8
		EVPLFOL4242	649	667	42	42	2 7/8
		EVPLFOL4248	703	715	42	48	2 7/8
		EVPLFOL4254	769	785	42	54	2 7/8
		EVPLFOL4260	834	857	42	60	2 7/8
	Open Bottom Light Panel - 54” High	EVPLFOL5418	450	464	54	18	2 7/8
		EVPLFOL5424	512	533	54	24	2 7/8
		EVPLFOL5430	588	607	54	30	2 7/8
		EVPLFOL5436	657	685	54	36	2 7/8
		EVPLFOL5442	732	764	54	42	2 7/8
		EVPLFOL5448	794	828	54	48	2 7/8
		EVPLFOL5454	868	906	54	54	2 7/8
		EVPLFOL5460	940	983	54	60	2 7/8
	Open Bottom Premium Panel - 66” High	EVPLFOL6618	583	605	60	18	2 7/8
		EVPLFOL6624	673	702	60	24	2 7/8
		EVPLFOL6630	767	800	60	30	2 7/8
		EVPLFOL6636	862	900	60	36	2 7/8
		EVPLFOL6642	967	1014	60	42	2 7/8
		EVPLFOL6648	1034	1087	60	48	2 7/8
		EVPLFOL6654	1142	1196	60	54	2 7/8
		EVPLFOL6660	1248	1312	60	60	2 7/8

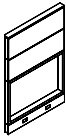

EVFPOL - OPEN BOTTOM PREMIUM PANEL

- Open Bottom Premium Panel incorporates bottom 24”H open module with individual fabric modules, within a steel frame.
- The 24”H open bottom module in the base section is to provide air circulation and access to electrical or data.
- Premium panels incorporate 12”H fabric modules above 30”H base section.
- Opposite sides of each panel may have a different fabric within the same grade at no upcharge.
- If different grades of fabric are used on one panel, the entire panel must be priced at highest grade.
- An aluminum low profile top cap is included.
- Stackability: Evolve panels can be increased in height in 6”H, 12”H, 18”H or 24”H increments. See Extension Module (pages 82-90) for part numbers.

	DESCRIPTION	PRODUCT CODE	LIST PRICE		DIMENSIONS/INCHES		
			Gr1	Gr2	H	W	D
	Open Bottom Premium Panel - 54” High	EVFPOL5418	554	570	54	18	2 7/8
		EVFPOL5424	634	658	54	24	2 7/8
		EVFPOL5430	725	750	54	30	2 7/8
		EVFPOL5436	813	841	54	36	2 7/8
		EVFPOL5442	916	949	54	42	2 7/8
		EVFPOL5448	982	1020	54	48	2 7/8
		EVFPOL5454	1080	1120	54	54	2 7/8
	Open Bottom Premium Panel - 66” High	EVFPOL6618	693	719	66	18	2 7/8
		EVFPOL6624	800	831	66	24	2 7/8
		EVFPOL6630	909	944	66	30	2 7/8
		EVFPOL6636	1026	1070	66	36	2 7/8
		EVFPOL6642	1158	1207	66	42	2 7/8
		EVFPOL6648	1240	1295	66	48	2 7/8
		EVFPOL6654	1374	1435	66	54	2 7/8
		EVFPOL6660	1506	1574	66	60	2 7/8

EVPLPOL - OPEN BOTTOM PREMIUM LIGHT PANEL

- Open Bottom Premium Light Panel incorporates bottom 24”H open module with individual fabric modules, within a steel frame.
- The 24”H open bottom module in the base section is to provide air circulation and access to electrical or data.
- Premium panels incorporate 12”H fabric modules above 30”H base section.
- There is no base raceway in Light Panels to accommodate electrical.
- Light Panel Connectors must be used in conjunction with Light Panels.
- Opposite sides of each panel may have a different fabric within the same grade at no upcharge.
- If different grades of fabric are used on one panel, the entire panel must be priced at highest grade.
- An aluminum low profile top cap is included.
- Stackability: Evolve panels can be increased in height in 6”H, 12”H, 18”H or 24”H increments. See Extension Module (pages 82-90) for part numbers.

	DESCRIPTION	PRODUCT CODE	LIST PRICE		DIMENSIONS/INCHES		
			Gr1	Gr2	H	W	D
	Open Bottom Premium Light Panel - 54” High	EVPLPOL5418	531	544	54	18	2 7/8
		EVPLPOL5424	608	631	54	24	2 7/8
		EVPLPOL5430	696	715	54	30	2 7/8
		EVPLPOL5436	780	808	54	36	2 7/8
		EVPLPOL5442	878	908	54	42	2 7/8
		EVPLPOL5448	942	977	54	48	2 7/8
		EVPLPOL5454	1037	1074	54	54	2 7/8
	Open Bottom Premium Light Panel - 66” High	EVPLPOL6618	666	686	60	18	2 7/8
		EVPLPOL6624	768	797	60	24	2 7/8
		EVPLPOL6630	871	908	60	30	2 7/8
		EVPLPOL6636	983	1022	60	36	2 7/8
		EVPLPOL6642	1111	1155	60	42	2 7/8
		EVPLPOL6648	1190	1242	60	48	2 7/8
		EVPLPOL6654	1317	1375	60	54	2 7/8
		EVPLPOL6660	1446	1511	60	60	2 7/8



EVVFO - OPEN MIDDLE PANEL - 12”H OPENING

- Open Middle Panel incorporates a 12”H middle position open module with fabric modules, within a steel frame.
- Open Middle Panel Incorporates a 12”H opening above 30”H base module to provide pass-through convenience.
- Opposite sides of each panel may have a different fabric within the same grade at no upcharge.
- If different grades of fabric are used on one panel, the entire panel must be priced at highest grade.
- An aluminum low profile top cap is included.
- Stackability: Evolve panels can be increased in height in 6”H, 12”H, 18”H or 24”H increments. See Extension Module (pages 82-90) for part numbers.

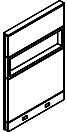
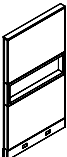
	DESCRIPTION	PRODUCT CODE	LIST PRICE		DIMENSIONS/INCHES		
			Gr1	Gr2	H	W	D
	Open Middle Panel - 12”H Opening - 54” High	EVVFO5418	560	587	54	18	2 7/8
		EVVFO5424	652	683	54	24	2 7/8
		EVVFO5430	750	786	54	30	2 7/8
		EVVFO5436	854	897	54	36	2 7/8
		EVVFO5442	961	1010	54	42	2 7/8
		EVVFO5448	1037	1094	54	48	2 7/8
		EVVFO5454	1150	1207	54	54	2 7/8
		EVVFO5460	1257	1326	54	60	2 7/8
	Open Middle Panel - 12”H Opening - 66” High	EVVFO6618	618	649	66	18	2 7/8
		EVVFO6624	714	753	66	24	2 7/8
		EVVFO6630	822	869	66	30	2 7/8
		EVVFO6636	932	989	66	36	2 7/8
		EVVFO6642	1052	1114	66	42	2 7/8
		EVVFO6648	1135	1210	66	48	2 7/8
		EVVFO6654	1259	1336	66	54	2 7/8
		EVVFO6660	1375	1466	66	60	2 7/8

EVPLFO - OPEN MIDDLE LIGHT PANEL - 12”H OPENING

- Open Middle Light Panel incorporates a 12”H middle position open module with fabric modules, within a steel frame.
- Open Middle Light Panel Incorporates a 12”H opening above 30”H base module to provide pass-through convenience.
- There is no base raceway in Light Panels to accommodate electrical.
- Light Panel Connectors must be used in conjunction with Light Panels.
- Opposite sides of each panel may have a different fabric within the same grade at no upcharge.
- If different grades of fabric are used on one panel, the entire panel must be priced at highest grade.
- An aluminum low profile top cap is included.
- Stackability: Evolve panels can be increased in height in 6”H, 12”H, 18”H or 24”H increments. See Extension Module (pages 82-90) for part numbers.

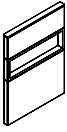
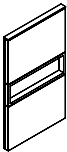
	DESCRIPTION	PRODUCT CODE	LIST PRICE		DIMENSIONS/INCHES		
			Gr1	Gr2	H	W	D
	Open Middle Light Panel - 12”H Opening - 54” High	EVPLFO5418	534	556	54	18	2 7/8
		EVPLFO5424	621	648	54	24	2 7/8
		EVPLFO5430	714	747	54	30	2 7/8
		EVPLFO5436	810	849	54	36	2 7/8
		EVPLFO5442	912	959	54	42	2 7/8
		EVPLFO5448	984	1034	54	48	2 7/8
		EVPLFO5454	1091	1146	54	54	2 7/8
		EVPLFO5460	1194	1257	54	60	2 7/8
	Open Middle Light Panel - 12”H Opening - 66” High	EVPLFO6618	588	616	60	18	2 7/8
		EVPLFO6624	678	715	60	24	2 7/8
		EVPLFO6630	779	824	60	30	2 7/8
		EVPLFO6636	887	939	60	36	2 7/8
		EVPLFO6642	1000	1058	60	42	2 7/8
		EVPLFO6648	1078	1146	60	48	2 7/8
		EVPLFO6654	1195	1270	60	54	2 7/8
		EVPLFO6660	1307	1389	60	60	2 7/8

EVFPFO - OPEN MIDDLE PREMIUM PANEL - 12”H OPENING

- Open Middle Premium Panel incorporates a 12”H middle position open module with fabric modules, within a steel frame.
- Open Middle Premium Panel Incorporates a 12”H opening above 30”H base module to provide pass-through convenience.
- Premium panels incorporate 12”H modules above 30”H base section.
- Opposite sides of each panel may have a different fabric within the same grade at no upcharge.
- If different grades of fabric are used on one panel, the entire panel must be priced at highest grade.
- An aluminum low profile top cap is included.
- Stackability: Evolve panels can be increased in height in 6”H, 12”H, 18”H or 24”H increments. See Extension Module (pages 82-90) for part numbers.

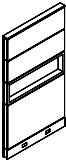
	DESCRIPTION	PRODUCT CODE	LIST PRICE		DIMENSIONS/INCHES		
			Gr1	Gr2	H	W	D
	Open Middle Premium Panel - 12”H Opening - 66” High	EVFPFO6618	703	734	66	18	2 7/8
		EVFPFO6624	813	857	66	24	2 7/8
		EVFPFO6630	935	985	66	30	2 7/8
		EVFPFO6636	1059	1113	66	36	2 7/8
		EVFPFO6642	1204	1268	66	42	2 7/8
		EVFPFO6648	1294	1368	66	48	2 7/8
		EVFPFO6654	1435	1514	66	54	2 7/8
		EVFPFO6660	1580	1671	66	60	2 7/8

EVPLFPO - OPEN MIDDLE PREMIUM LIGHT PANEL - 12” OPENING

- Open Middle Premium Light Panel incorporates a 12”H middle position open module with fabric modules, within a steel frame.
- Open Middle Premium Light Panel Incorporates a 12”H opening above 30”H base module to provide pass-through convenience.
- Premium panels incorporate 12”H modules above 30”H base section.
- There is no base raceway in Light Panels to accommodate electrical.
- Light Panel Connectors must be used in conjunction with Light Panels.
- Opposite sides of each panel may have a different fabric within the same grade at no upcharge.
- If different grades of fabric are used on one panel, the entire panel must be priced at highest grade.
- An aluminum low profile top cap is included.
- Stackability: Evolve panels can be increased in height in 6”H, 12”H, 18”H or 24”H increments. See Extension Module (pages 82-90) for part numbers.

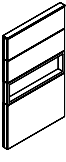
	DESCRIPTION	PRODUCT CODE	LIST PRICE		DIMENSIONS/INCHES		
			Gr1	Gr2	H	W	D
	Open Middle Premium Light Panel - 12”H Opening - 66” High	EVPLFPO6618	667	696	66	18	2 7/8
		EVPLFPO6624	774	810	66	24	2 7/8
		EVPLFPO6630	888	931	66	30	2 7/8
		EVPLFPO6636	1006	1055	66	36	2 7/8
		EVPLFPO6642	1144	1204	66	42	2 7/8
		EVPLFPO6648	1230	1296	66	48	2 7/8
		EVPLFPO6654	1363	1436	66	54	2 7/8
		EVPLFPO6660	1501	1584	66	60	2 7/8



EVFOX - OPEN MIDDLE PANEL - 24”H OPENING

- Open Middle Panel incorporates a 24”H middle position open module with fabric modules, within a steel frame.
- Open Middle Panel Incorporates a 24”H opening above 30”H base module to provide pass-through convenience.
- Opposite sides of each panel may have a different fabric within the same grade at no upcharge.
- If different grades of fabric are used on one panel, the entire panel must be priced at highest grade.
- An aluminum low profile top cap is included.
- Stackability: Evolve panels can be increased in height in 6”H, 12”H, 18”H or 24”H increments. See Extension Module (pages 82-90) for part numbers.

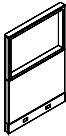
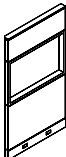
	DESCRIPTION	PRODUCT CODE	LIST PRICE		DIMENSIONS/INCHES		
			Gr1	Gr2	H	W	D
	Open Middle Panel - 24”H Opening - 54” High	EVFOX5418	469	486	54	18	2 7/8
		EVFOX5424	534	558	54	24	2 7/8
		EVFOX5430	612	636	54	30	2 7/8
		EVFOX5436	685	716	54	36	2 7/8
		EVFOX5442	763	796	54	42	2 7/8
		EVFOX5448	822	860	54	48	2 7/8
		EVFOX5454	902	940	54	54	2 7/8
		EVFOX5460	978	1026	54	60	2 7/8
	Open Middle Panel - 24”H Opening - 66” High	EVFOX6618	608	634	66	18	2 7/8
		EVFOX6624	699	730	66	24	2 7/8
		EVFOX6630	822	860	66	30	2 7/8
		EVFOX6636	897	938	66	36	2 7/8
		EVFOX6642	1007	1058	66	42	2 7/8
		EVFOX6648	1078	1132	66	48	2 7/8
		EVFOX6654	1191	1250	66	54	2 7/8
		EVFOX6660	1297	1366	66	60	2 7/8

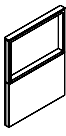
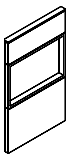

EVPLFOX - OPEN MIDDLE LIGHT PANEL - 24”H OPENING

- Open Middle Panel incorporates a 24”H middle position open module with fabric modules, within a steel frame.
- Open Middle Panel Incorporates a 24”H opening above 30”H base module to provide pass-through convenience.
- There is no base raceway in Light Panels to accommodate electrical.
- Light Panel Connectors must be used in conjunction with Light Panels.
- Opposite sides of each panel may have a different fabric within the same grade at no upcharge.
- If different grades of fabric are used on one panel, the entire panel must be priced at highest grade.
- An aluminum low profile top cap is included.
- Stackability: Evolve panels can be increased in height in 6”H, 12”H, 18”H or 24”H increments. See Extension Module (pages 82-90) for part numbers.

	DESCRIPTION	PRODUCT CODE	LIST PRICE		DIMENSIONS/INCHES		
			Gr1	Gr2	H	W	D
	Open Middle Light Panel - 24”H Opening - 54” High	EVPLFOX5418	445	459	54	18	2 7/8
		EVPLFOX5424	505	527	54	24	2 7/8
		EVPLFOX5430	581	601	54	30	2 7/8
		EVPLFOX5436	652	678	54	36	2 7/8
		EVPLFOX5442	719	750	54	42	2 7/8
		EVPLFOX5448	779	813	54	48	2 7/8
		EVPLFOX5454	858	896	54	54	2 7/8
		EVPLFOX5460	930	972	54	60	2 7/8
	Open Middle Light Panel - 24”H Opening - 66” High	EVPLFOX6618	577	600	66	18	2 7/8
		EVPLFOX6624	665	693	66	24	2 7/8
		EVPLFOX6630	779	813	66	30	2 7/8
		EVPLFOX6636	851	888	66	36	2 7/8
		EVPLFOX6642	957	1003	66	42	2 7/8
		EVPLFOX6648	1022	1074	66	48	2 7/8
		EVPLFOX6654	1130	1185	66	54	2 7/8
		EVPLFOX6660	1235	1296	66	60	2 7/8

EVPFANR - SEGMENTED NO RACEWAY PANEL

- Segmented No Raceway panel incorporates fabric modules within steel frame.
- There is no base raceway in No Raceway Panels to accommodate electric.
- No Raceway connectors to be used.
- Fabric covered modules are tackable and acoustical.
- Each side of fabric module may have different fabric within the same grade at no charge.
- If different grades of fabric are used, the entire module must be price at highest grade.
- Aluminum low profile top and bottom cap is included.
- Stackability: Evolve panels can be increased in height in 6”H, 12”H, 18”H, 24”H increments. See module listing for part numbers See Extension Module (pages 82-90) for part numbers.

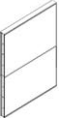
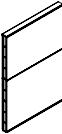
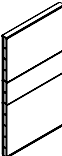
	DESCRIPTION	PRODUCT CODE	LIST PRICE		DIMENSIONS/INCHES		
			Gr1	Gr2	H	W	D
	Segmented NR Panel - 30" High	EVPPFA3018NR	371	385	30	18	2 7/8
		EVPPFA3024NR	385	407	30	24	2 7/8
		EVPPFA3030NR	432	453	30	30	2 7/8
		EVPPFA3036NR	466	494	30	36	2 7/8
		EVPPFA3042NR	499	533	30	42	2 7/8
		EVPPFA3048NR	548	588	30	48	2 7/8
		EVPPFA3054NR	594	634	30	54	2 7/8
	Segmented NR Panel - 42" High	EVPPFA4218NR	411	435	42	18	2 7/8
		EVPPFA4224NR	436	466	42	24	2 7/8
		EVPPFA4230NR	504	542	42	30	2 7/8
		EVPPFA4236NR	542	587	42	36	2 7/8
		EVPPFA4242NR	621	666	42	42	2 7/8
		EVPPFA4248NR	666	721	42	48	2 7/8
		EVPPFA4254NR	737	800	42	54	2 7/8
	Segmented NR Panel - 48" High	EVPPFA4818NR	442	475	48	18	2 7/8
		EVPPFA4824NR	481	523	48	24	2 7/8
		EVPPFA4830NR	553	600	48	30	2 7/8
		EVPPFA4836NR	615	674	48	36	2 7/8
		EVPPFA4842NR	695	763	48	42	2 7/8
		EVPPFA4848NR	774	847	48	48	2 7/8
		EVPPFA4854NR	839	918	48	54	2 7/8
	Segmented NR Panel - 54" High	EVPPFA5418NR	442	475	54	18	2 7/8
		EVPPFA5424NR	481	523	54	24	2 7/8
		EVPPFA5430NR	553	600	54	30	2 7/8
		EVPPFA5436NR	615	674	54	36	2 7/8
		EVPPFA5442NR	695	763	54	42	2 7/8
		EVPPFA5448NR	774	847	54	48	2 7/8
		EVPPFA5454NR	839	918	54	54	2 7/8
	Segmented NR Panel - 66" High	EVPPFA6618NR	556	596	66	18	2 7/8
		EVPPFA6624NR	597	648	66	24	2 7/8
		EVPPFA6630NR	664	721	66	30	2 7/8
		EVPPFA6636NR	776	849	66	36	2 7/8
		EVPPFA6642NR	874	956	66	42	2 7/8
		EVPPFA6648NR	940	1032	66	48	2 7/8
		EVPPFA6654NR	1019	1121	66	54	2 7/8
EVPPFA6660NR	1104	1216	66	60	2 7/8		





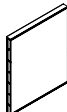
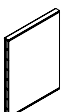
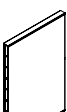
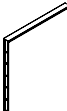
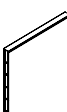

EVPFAMNR - MONOLITHIC NO RACEWAY PANEL

- Monolithic No Raceway panel incorporates fabric modules within steel frame.
- There is no base raceway in No Raceway Panels to accommodate electric.
- No Raceway connectors to be used.
- Fabric covered modules are tackable and acoustical.
- Each side of fabric module may have different fabric within the same grade at no charge.
- If different grades of fabric are used, the entire module must be price at highest grade.
- Aluminum low profile top and bottom cap is included.
- Stackability: Evolve panels can be increased in height in 6”H, 12”H, 18”H, 24”H increments. See module listing for part numbers See Extension Module (pages 82-90) for part numbers.

	DESCRIPTION	PRODUCT CODE	LIST PRICE		DIMENSIONS/INCHES		
			Gr1	Gr2	H	W	D
	Monolithic NR Panel 42" High	EVPFAM4218NR	383	416	42	18	2 7/8
		EVPFAM4224NR	407	446	42	24	2 7/8
		EVPFAM4230NR	469	517	42	30	2 7/8
		EVPFAM4236NR	499	556	42	36	2 7/8
		EVPFAM4242NR	553	622	42	42	2 7/8
		EVPFAM4248NR	600	678	42	48	2 7/8
		EVPFAM4254NR	658	744	42	54	2 7/8
		EVPFAM4260NR	714	807	42	60	2 7/8
	Monolithic NR Panel - 48" High	EVPFAM4818NR	388	421	48	18	2 7/8
		EVPFAM4824NR	425	470	48	24	2 7/8
		EVPFAM4830NR	493	542	48	30	2 7/8
		EVPFAM4836NR	536	594	48	36	2 7/8
		EVPFAM4842NR	597	666	48	42	2 7/8
		EVPFAM4848NR	648	725	48	48	2 7/8
		EVPFAM4854NR	717	805	48	54	2 7/8
		EVPFAM4860NR	779	872	48	60	2 7/8
	Monolithic NR Panel - 54" High	EVPFAM5418NR	393	425	54	18	2 7/8
		EVPFAM5424NR	432	472	54	24	2 7/8
		EVPFAM5430NR	501	553	54	30	2 7/8
		EVPFAM5436NR	556	616	54	36	2 7/8
		EVPFAM5442NR	622	689	54	42	2 7/8
		EVPFAM5448NR	676	750	54	48	2 7/8
		EVPFAM5454NR	737	829	54	54	2 7/8
		EVPFAM5460NR	810	906	54	60	2 7/8
	Monolithic NR Panel - 66" High	EVPFAM6618NR	483	517	66	18	2 7/8
		EVPFAM6624NR	532	574	66	24	2 7/8
		EVPFAM6630NR	597	649	66	30	2 7/8
		EVPFAM6636NR	695	753	66	36	2 7/8
		EVPFAM6642NR	779	847	66	42	2 7/8
		EVPFAM6648NR	844	919	66	48	2 7/8
		EVPFAM6654NR	940	1021	66	54	2 7/8
		EVPFAM6660NR	1033	1124	66	60	2 7/8
	Monolithic NR Panel - 90" High	EVPFAM9018NR	849	911	90	18	2 7/8
		EVPFAM9024NR	919	994	90	24	2 7/8
		EVPFAM9030NR	1022	1118	90	30	2 7/8
		EVPFAM9036NR	1190	1295	90	36	2 7/8

EVPH1SNR - LAMINATE NO RACEWAY - PANEL SINGLE SIDED



- Laminate No Raceway panel incorporates single sided laminate modules within steel frame.
- Opposite side is fabric covered.
- Laminate faces on all modules provide durable, washable surfaces on One Side of the panel.
- Available in high pressure laminate only.
- If wood grain is selected, grain runs horizontally.
- There is no base raceway in No Raceway Panels to accommodate electric.
- No Raceway connectors to be used.
- If different grades of fabric are used, the entire module must be priced at highest grade.
- An aluminum low profile top and bottom cap is included.
- Stackability: Evolve panels can be increased in height in 6”H, 12”H, 18”H, 24”H increments. See module listing for part numbers.

	DESCRIPTION	PRODUCT CODE	LIST PRICE		DIMENSIONS/INCHES		
			Gr1	Gr2	H	W	D
	Laminate NR Panel - Single Sided - 30" High	EVPH1S3018NR	456	464	30	18	2 7/8
		EVPH1S3024NR	546	557	30	24	2 7/8
		EVPH1S3030NR	634	646	30	30	2 7/8
		EVPH1S3036NR	721	737	30	36	2 7/8
		EVPH1S3042NR	821	834	30	42	2 7/8
		EVPH1S3048NR	891	908	30	48	2 7/8
		EVPH1S3054NR	983	1007	30	54	2 7/8
		EVPH1S3060NR	1081	1103	30	60	2 7/8
	Laminate NR Panel - Single Sided - 42" High	EVPH1S4218NR	543	554	42	18	2 7/8
		EVPH1S4224NR	645	664	42	24	2 7/8
		EVPH1S4230NR	757	775	42	30	2 7/8
		EVPH1S4236NR	866	888	42	36	2 7/8
		EVPH1S4242NR	981	1007	42	42	2 7/8
		EVPH1S4248NR	1067	1095	42	48	2 7/8
		EVPH1S4254NR	1183	1216	42	54	2 7/8
		EVPH1S4260NR	1296	1334	42	60	2 7/8
	Laminate NR Panel - Single Sided - 54" High	EVPH1S5418NR	635	646	54	18	2 7/8
		EVPH1S5424NR	767	788	54	24	2 7/8
		EVPH1S5430NR	899	922	54	30	2 7/8
		EVPH1S5436NR	1028	1055	54	36	2 7/8
		EVPH1S5442NR	1163	1199	54	42	2 7/8
		EVPH1S5448NR	1272	1311	54	48	2 7/8
		EVPH1S5454NR	1413	1452	54	54	2 7/8
		EVPH1S5460NR	1553	1599	54	60	2 7/8
	Laminate NR Panel - Single Sided - 66" High	EVPH1S6618NR	786	808	66	18	2 7/8
		EVPH1S6624NR	945	974	66	24	2 7/8
		EVPH1S6630NR	1105	1140	66	30	2 7/8
		EVPH1S6636NR	1275	1313	66	36	2 7/8
		EVPH1S6642NR	1448	1489	66	42	2 7/8
		EVPH1S6648NR	1448	1489	66	48	2 7/8
		EVPH1S6654NR	1757	1807	66	54	2 7/8
		EVPH1S6660NR	1931	1989	66	60	2 7/8

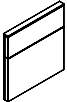
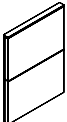

EVPH2SNR - LAMINATE NO RACEWAY - PANEL DOUBLE SIDED

- Laminate No Raceway panel incorporates double sided laminate modules, within steel frame.
- Laminate faces on all modules provide durable, washable surfaces on both sides of the panel.
- Available in high pressure laminate only.
- If wood grain is selected, grain runs horizontally.
- There is no base raceway in No Raceway Panels to accommodate electric.
- No Raceway connectors to be used.
- If different grades of fabric are used, the entire module must be priced at highest grade.
- An aluminum low profile top and bottom cap is included.
- Stackability: Evolve panels can be increased in height in 6”H, 12”H, 18”H, 24”H increments. See module listing for part numbers.

	DESCRIPTION	PRODUCT CODE	LIST PRICE	DIMENSIONS/INCHES		
				H	W	D
	Laminate NR Panel - Double Sided - 30" High	EVPH2S3018NR	622	30	18	2 7/8
		EVPH2S3024NR	622	30	24	2 7/8
		EVPH2S3030NR	734	30	30	2 7/8
		EVPH2S3036NR	839	30	36	2 7/8
		EVPH2S3042NR	954	30	42	2 7/8
		EVPH2S3048NR	1066	30	48	2 7/8
		EVPH2S3054NR	1181	30	54	2 7/8
EVPH2S3060NR	1275	30	60	2 7/8		
	Laminate NR Panel - Double Sided - 42" High	EVPH2S4218NR	604	42	18	2 7/8
		EVPH2S4224NR	734	42	24	2 7/8
		EVPH2S4230NR	865	42	30	2 7/8
		EVPH2S4236NR	1004	42	36	2 7/8
		EVPH2S4242NR	1144	42	42	2 7/8
		EVPH2S4248NR	1282	42	48	2 7/8
		EVPH2S4254NR	1410	42	54	2 7/8
EVPH2S4260NR	1533	42	60	2 7/8		
	Laminate NR Panel - Double Sided - 54" High	EVPH2S5418NR	708	54	18	2 7/8
		EVPH2S5424NR	867	54	24	2 7/8
		EVPH2S5430NR	1027	54	30	2 7/8
		EVPH2S5436NR	1192	54	36	2 7/8
		EVPH2S5442NR	1362	54	42	2 7/8
		EVPH2S5448NR	1531	54	48	2 7/8
		EVPH2S5454NR	1687	54	54	2 7/8
EVPH2S5460NR	1834	54	60	2 7/8		
	Laminate NR Panel - Double Sided - 66" High	EVPH2S6618NR	891	66	18	2 7/8
		EVPH2S6624NR	1095	66	24	2 7/8
		EVPH2S6630NR	1296	66	30	2 7/8
		EVPH2S6636NR	1504	66	36	2 7/8
		EVPH2S6642NR	1723	66	42	2 7/8
		EVPH2S6648NR	1931	66	48	2 7/8
		EVPH2S6654NR	2132	66	54	2 7/8
EVPH2S6660NR	2328	66	60	2 7/8		

EVPGTNR - FULLY GLAZED SEGMENTED NO RACEWAY PANEL

PANELS

FULLY GLAZED MONOLITHIC - NO RACEWAY

- Fully Glazed Segmented No Raceway Panels are incorporated in solid steel frame
- There is no base raceway in No Raceway Panels to accommodate electric
- No Raceway connectors to be used
- Standard in clear (CLR) glass.
- Frosted glass (FRST) 40% upcharge
- Aluminum low profile top and bottom cap is included
- Stackability: Evolve panels can be increased in height in 6"H, 12"H, 18"H, 24"H increments. See module listing for part numbers.

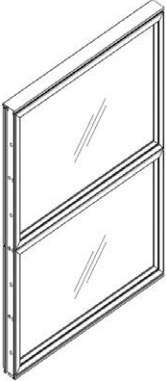
DESCRIPTION	PRODUCT CODE	LIST PRICE	DIMENSIONS/INCHES		
			H	W	D
 Glazed Segmented NR Panel 48" H	EVPGT4818NR	748	48	18	2 7/8
	EVPGT4824NR	919	48	24	2 7/8
	EVPGT4830NR	1017	48	30	2 7/8
	EVPGT4836NR	1110	48	36	2 7/8
	EVPGT4842NR	1229	48	42	2 7/8
	EVPGT4848NR	1371	48	48	2 7/8
	EVPGT4854NR	1509	48	54	2 7/8
	EVPGT4860NR	1646	48	60	2 7/8

EVPXGTNR - FULLY GLAZED MONOLITHIC NO RACEWAY PANEL

- Fully Glazed Monolithic No Raceway Panels are incorporated in solid steel frame.
- There is no base raceway in No Raceway Panels to accommodate electric.
- No Raceway connectors to be used.
- Standard in clear (CLR) glass.
- Frosted glass (FRST) 40% upcharge.
- Size 90"x36"W is maximum size allowed.
- Panel height to align with standard door height.
- Aluminum low profile top and bottom cap is included.
- Stackability: Evolve panels can be increased in height in 6"H, 12"H, 18"H, 24"H increments. See module listing for part numbers.

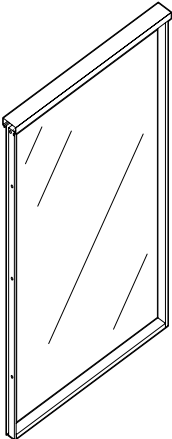
DESCRIPTION	PRODUCT CODE	LIST PRICE	DIMENSIONS/INCHES		
			H	W	D
 Glazed Monolithic NR Panel 90" High	EVPXGT9018NR	951	90	18	2 7/8
	EVPXGT9024NR	1085	90	24	2 7/8
	EVPXGT9030NR	1230	90	30	2 7/8
	EVPXGT9036NR	1330	90	36	2 7/8



EVPICNR - INLINE CONNECTOR NO RACEWAY PANEL

- Connects two No Raceway Panels in a straight run.
- Provides slotted support for worksurfaces and hang on components.
- Includes one slotted connector with leveling glide and connecting hardware.
- Connectors are available without slots, as a special at no extra charge. Contact Customer Support.

	DESCRIPTION	PRODUCT CODE	LIST PRICE	DIMENSIONS/INCHES		
				H	W	D
	Inline Connector No Raceway Panel	EVPIC30NR	77	30	2	
	To be used only with 90" H NR Glazed Panels	EVPIC42NR	90	42	2	
		EVPIC48NR	94	48	2	
		EVPIC54NR	97	54	2	
		EVPIC66NR	108	66	2	

EVPICPNR - INLINE CONNECTOR PANEL - NO RACEWAY PANEL

- Connects Panel to No Raceway panel in straight run.
- Provides slotted support for worksurfaces and hang on components.
- Includes one slotted connector with leveling glide and connecting hardware.
- Connectors are available without slots, as a special at no extra charge. Contact Customer Support.
- Note: Allows to connect panel to NR panel in straight run.

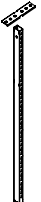
	DESCRIPTION	PRODUCT CODE	LIST PRICE	DIMENSIONS/INCHES		
				H	W	D
	Inline Connector Panel - No Raceway Panel	EVPIC30PNR	74	30	2	
		EVPIC42PNR	86	42	2	
		EVPIC48PNR	90	48	2	
		EVPIC54PNR	92	54	2	
		EVPIC66PNR	102	66	2	

EVPIC90NR - INLINE CONNECTOR NO RACEWAY PANEL

- Connects two 90" H No Raceway panel in straight run.
- Includes one slotted connector with leveling glide and connecting hardware.
- Connectors are without slots
- To be used only with 90" H NR Glazed Panels.

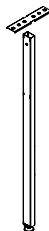
	DESCRIPTION	PRODUCT CODE	LIST PRICE	DIMENSIONS/INCHES		
				H	W	D
	Inline Connector No Raceway Panel	EVPIC90NR	162	90	2	

EVVIC90PNR - INLINE CONNECTOR PANEL - NO RACEWAY PANEL

- Connects 90" H No Raceway panel to 90" H door in straight run.
- Includes one non slotted connector with leveling glide and connecting hardware
- Connectors are without slots.
- Note: To be used only with 90" H NR Glazed Panels and 90" H door

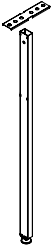
	DESCRIPTION	PRODUCT CODE	LIST PRICE	DIMENSIONS/INCHES		
				H	W	D
	Inline Connector Panel - No Raceway Panel	EVVIC90PNR	162	90	2	

EVVVCNR - INLINE VARIABLE HEIGHT CONNECTOR NO RACEWAY PANEL

- Connects two No Raceway panels of differing height in straight run.
- Connector must reference taller panel.
- Can be used for any variation of panel height.
- Variable height trim must be ordered separately (see EVPTVA).
- Provides slotted support for worksurfaces and hang on components.
- Includes one slotted connector with leveling glide and connecting hardware.
- Connectors are available without slots, as a special at no extra charge. Contact customer support..

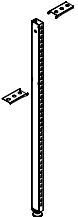
	DESCRIPTION	PRODUCT CODE	LIST PRICE	DIMENSIONS/INCHES		
				H	W	D
	Inline Variable Height Connector No Raceway Panel	EVVVC42NR	97	42	2	
		EVVVC48NR	99	48	2	
		EVVVC54NR	101	54	2	
		EVVVC66NR	109	66	2	

EVVVC66PNR - INLINE VARIABLE HEIGHT CONNECTOR PANEL - NO RACEWAY PANEL

- Connects Panel to No Raceway panels of differing height in straight run.
- Connector must reference taller panel.
- Can be used for any variation of panel height.
- Variable height trim must be ordered separately (see EVPTVA).
- Provides slotted support for worksurfaces and hang on components.
- Includes one slotted connector with leveling glide and connecting hardware.
- Connectors are available without slots, as a special at no extra charge. Contact customer support.
- Note: Allows to connect panel to NR panel in straight run

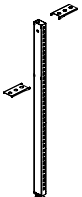
	DESCRIPTION	PRODUCT CODE	LIST PRICE	DIMENSIONS/INCHES		
				H	W	D
	Inline Variable Height Connector Panel - No Raceway Panel	EVVVC42PNR	102	42	2	
		EVVVC48PNR	109	48	2	
		EVVVC54PNR	123	54	2	
		EVVVC66PNR	136	66	2	



EVPERANR - END OF RUN POST KIT FOR NO RACEWAY PANEL

- Connects at end of No Raceway panel and can attach to a panel to fixed wall.
- Adds 1" to width of panel run.
- Provides slotted support for worksurfaces and hang on components.
- Includes one slotted connector with leveling glide and connecting hardware and glide and connecting hardware and trim kit.
- Can be attached to face of another panel to provide off modular connection.
- Connectors are available without slots, as a special at no extra charge. Contact customer support.

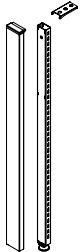
DESCRIPTION	PRODUCT CODE	LIST PRICE	DIMENSIONS/INCHES		
			H	W	D
 End End of Run Post Kit No Raceway Panel	EVPERA30NR	94	30	2	
	EVPERA42NR	108	42	2	
	EVPERA48NR	114	48	2	
	EVPERA54NR	128	54	2	
	EVPERA66NR	142	66	2	

EVPERA90NR - END OF RUN POST KIT FOR NO RACEWAY PANEL

- Connects two 90" H No Raceway panel and can attach to a panel to fixed wall.
- Adds 1" to width of panel run.
- Includes Non-Slotted connector with leveling glide and connecting hardware and trim kit.
- Can be attached to face of another panel to provide off modular connection.
- Connectors are without slots.
- To be used only with 90" H NR Glazed Panels.

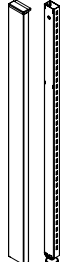
DESCRIPTION	PRODUCT CODE	LIST PRICE	DIMENSIONS/INCHES		
			H	W	D
 End End of Run Post Kit To be used only with 90" H NR Glazed Panels	EVPERA90NR	203	66	2	

EVPCPA1NR - ONE WAY CORNER POST NO RACEWAY PANEL

- Connects at end of No Raceway panel run in place of EVPERA- End of run post kit.
- Should not be used to attach panel to fixed wall.
- Post and connecting hardware add 3.25" to power beam run.
- Provides slotted support for worksurfaces and hang on components.
- Includes post, panel connectors and power beam connectors, post with trim all around, levelling glide, hardware and trim kit.
- Connectors are available without slots, as a special at no extra charge. Contact customer support.

	DESCRIPTION	PRODUCT CODE	LIST PRICE	DIMENSIONS/INCHES		
				H	W	D
	One Way Corner Post	EVPCPA130NR	125	30	2 7/8	
	No Raceway Panel	EVPCPA142NR	142	42	2 7/8	
		EVPCPA148NR	167	48	2 7/8	
		EVPCPA154NR	190	54	2 7/8	
		EVPCPA166NR	233	66	2 7/8	

EVPCPA190NR - ONE WAY CORNER POST NO RACEWAY PANEL

- Connects at end of 90" H No Raceway panel run in place of EVPERA - End of run post kit.
- Should not be used to attach panel to fixed wall.
- Post and connecting hardware add 3.25" to power beam run.
- Includes post, panel connectors and power beam connectors, post with trim all around, levelling glide, hardware and trim kit.
- Connectors are without slots.
- To be used only with 90" H NR Glazed Panels.

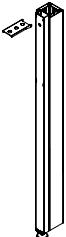
	DESCRIPTION	PRODUCT CODE	LIST PRICE	DIMENSIONS/INCHES		
				H	W	D
	One Way Corner Post No Raceway Panel To be used only with 90" H NR Glazed Panels	EVPCPA190NR	344	90	2 7/8	



EVPIPA2NR - INLINE TWO WAY CORNER POST NO RACEWAY PANEL

- Connects two No Raceway panel of equal height in straight run.
- Post and connecting hardware add 3.25" to power beam run.
- Provides slotted support for worksurfaces and hang on components.
- Includes post, panel connectors and power beam connectors, post with trim all around, levelling glide, hardware and trim kit.
- Connectors are available without slots, as a special at no extra charge. Contact customer support.

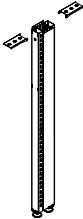
	DESCRIPTION	PRODUCT CODE	LIST PRICE	DIMENSIONS/INCHES		
				H	W	D
	Inline Two Way Corner Post	EVPIPA230NR	171	30	2 7/8	
	No Raceway Panel	EVPIPA242NR	216	42	2 7/8	
		EVPIPA248NR	236	48	2 7/8	
		EVPIPA254NR	258	54	2 7/8	
		EVPIPA266NR	306	66	2 7/8	

EVPIPA290NR - INLINE TWO WAY CORNER POST NO RACEWAY PANEL

- Connects two No Raceway panel of equal height in a straight run.
- Post and connecting hardware add 3.25" to power beam run.
- Includes post, panel connectors and power beam connectors, post with trim all around, levelling glide, hardware and trim kit.
- Connectors are without slots.
- To be used only with 90" H NR Glazed Panels.

	DESCRIPTION	PRODUCT CODE	LIST PRICE	DIMENSIONS/INCHES		
				H	W	D
	Inline Two Way Corner Post	EVPIPA290NR	460	90	2 7/8	
	No Raceway Panel					
	To be used only with 90" H NR Glazed Panels					

EVPCPA2PNR - TWO WAY CORNER POST NO RACEWAY PANEL-PANEL

- Connects No Raceway panel and Raceway Panel of equal height in 90 degree configuration.
- Post and connecting hardware add 3.25" to power beam run.
- Provides slotted support for worksurfaces and hang on components.
- Includes post, panel connectors and power beam connectors, post with trim all around, levelling glide, hardware and trim kit.
- Connectors are available without slots, as a special at no extra charge. Contact customer support.

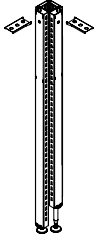
	DESCRIPTION	PRODUCT CODE	LIST PRICE	DIMENSIONS/INCHES		
				H	W	D
	Two Way Corner Post	EVPCPA230PNR	175	30	2 7/8	
	No Raceway Panel	EVPCPA242PNR	219	42	2 7/8	
		EVPCPA248PNR	233	48	2 7/8	
		EVPCPA254PNR	270	54	2 7/8	
		EVPCPA266PNR	321	66	2 7/8	

EVPCPA290NR - TWO WAY CORNER POST NO RACEWAY PANEL

- Connects two 90" H No Raceway panels of equal height in "T" configuration.
- Post and connecting hardware add 3.25" to power beam run.
- Includes post, panel connectors and power beam connectors, post with trim all around, levelling glide, hardware and trim kit.
- Connectors are without slots.
- To be used only with 90" H NR Glazed Panels.

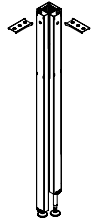
	DESCRIPTION	PRODUCT CODE	LIST PRICE	DIMENSIONS/INCHES		
				H	W	D
	Two Way Corner Post No Raceway Panel To be used only with 90" H NR Glazed Panels	EVPCPA290NR	461	90	2 7/8	



EVPCPA3PNR - THREE WAY CORNER POST NO RACEWAY PANEL-PANEL-NO RACEWAY PANEL

- Connects two No Raceway panels and Raceway Panels of equal height in "T" configuration.
- Post and connecting hardware add 3.25" to power beam run.
- Provides slotted support for worksurfaces and hang on components.
- Includes post, panel connectors and power beam connectors, post with trim all around, levelling glide, hardware and trim kit.
- Connectors are available without slots, as a special at no extra charge. Contact customer support.

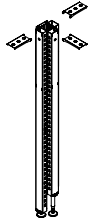

DESCRIPTION	PRODUCT CODE	LIST PRICE	DIMENSIONS/INCHES		
			H	W	D
Three Way Corner Post	EVPCPA330PNR	218	30	2 7/8	
No Raceway Panel	EVPCPA342PNR	291	42	2 7/8	
	EVPCPA348PNR	321	48	2 7/8	
	EVPCPA354PNR	352	54	2 7/8	
	EVPCPA366PNR	415	66	2 7/8	

EVPCPA3PNRP - THREE WAY CORNER POST PANEL-NO RACEWAY PANEL-PANEL

- Connects two panels and No raceway Panel of equal height in "T" configuration.
- Post and connecting hardware add 3.25" to power beam run.
- Provides slotted support for worksurfaces and hang on components.
- Includes post, panel connectors and power beam connectors, post with trim all around, levelling glide, hardware and trim kit.
- Connectors available without slots, as a special at no extra charge. Contact CustomerCare

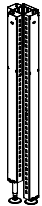

DESCRIPTION	PRODUCT CODE	LIST PRICE	DIMENSIONS/INCHES		
			H	W	D
Three Way Corner Post	EVPCPA330PNRP	218	30	2 7/8	
No Raceway Panel	EVPCPA342PNRP	291	42	2 7/8	
	EVPCPA348PNRP	321	48	2 7/8	
	EVPCPA354PNRP	352	54	2 7/8	
	EVPCPA366PNRP	415	66	2 7/8	

EVPCPA390NR - THREE WAY CORNER POST NO RACEWAY PANEL

- Connects two 90" H No Raceway panels of equal height in "T" configuration.
- Post and connecting hardware add 3.25" to power beam run.
- Includes post, panel connectors and power beam connectors, post with trim all around, levelling glide, hardware and trim kit.
- Connectors are without slots.
- To be used only with 90" H NR Glazed Panels.

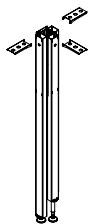

DESCRIPTION	PRODUCT CODE	LIST PRICE	DIMENSIONS/INCHES		
			H	W	D
Three Way Corner Post	EVPCPA390NR	582	90	2 7/8	
No Raceway Panel					
To be used only with 90" H NR Glazed Panels					

EVPCPA4PNR - FOUR WAY CORNER POST NO RACEWAY PANEL-PANEL-NO RACEWAY PANEL-PANEL

- Connects two No Raceway panels and two Raceway panels of equal height in "+" configuration.
- Post and connecting hardware add 3.25" to power beam run.
- Provides slotted support for worksurfaces and hang on components.
- Includes post, panel connectors and power beam connectors, post with trim all around, levelling glide, hardware and trim kit.
- Connectors are available without slots, as a special at no extra charge. Contact customer support.

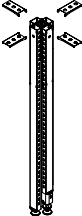
	DESCRIPTION	PRODUCT CODE	LIST PRICE	DIMENSIONS/INCHES		
				H	W	D
	Four Way Corner Post	EVPCPA430PNR	267	30	2 7/8	
	No Raceway Panel	EVPCPA442PNR	341	42	2 7/8	
		EVPCPA448PNR	378	48	2 7/8	
		EVPCPA454PNR	412	54	2 7/8	
		EVPCPA466PNR	483	66	2 7/8	

EVPCPA490NR - FOUR WAY CORNER POST NO RACEWAY PANEL

- Connects four 90" H No Raceway panels of equal height in "+" configuration.
- Post and connecting hardware add 3.25" to power beam run.
- Includes post, panel connectors and power beam connectors, post with trim all around, levelling glide, hardware and trim kit.
- Connectors are without slots.
- To be used only with 90" H NR Glazed Panels.

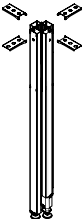
	DESCRIPTION	PRODUCT CODE	LIST PRICE	DIMENSIONS/INCHES		
				H	W	D
	Four Way Corner Post No Raceway Panel To be used only with 90" H NR Glazed Panels	EVPCPA490NR	668	90	2 7/8	



EVLEPDSNC - LAMINATE DOUBLE SIDED GALLERY PANEL, FINISHED ENDS

- Attaches to end of run connector with "U" channel.
- To be installed at end of panel run.
- Finished in thermally fused laminate.
- No connection on both sides.
- Laminate Gallery Panel height is inclusive of panel glides extended to their full height.
- If wood grain is selected, grain runs horizontally.
- End of run connector with "U" channel and bottom connecting brackets to be ordered separately.

	DESCRIPTION	PRODUCT CODE	LIST PRICE	DIMENSIONS/INCHES		
			LP	H	W	D
	Laminate Double Sided Gallery Panel	EVLEPDS4251NC	692	42	51	1
	Finished Ends - 42" High	EVLEPDS4263NC	901	42	63	1
		EVLEPDS4275NC	1110	42	75	1
	Laminate Double Sided Gallery Panel	EVLEPDS4851NC	754	48	51	1
	Finished Ends - 48" High	EVLEPDS4863NC	999	48	63	1
		EVLEPDS4875NC	1214	48	75	1
	Laminate Double Sided Gallery Panel	EVLEPDS5451NC	875	54	51	1
	Finished Ends - 54" High	EVLEPDS5463NC	1143	54	63	1
		EVLEPDS5475NC	1322	54	75	1





EVLEPDS - LAMINATE DOUBLE SIDED GALLERY PANEL, CONNECTOR ENDS

- Attaches to end of run connector with "U" channel.
- To be installed at end of panel run.
- Finished in thermally fused laminate.
- Locking connection both sides.
- Laminate Gallery Extension Panel height is inclusive of panel glides extended to their full height.
- If wood grain is selected, grain runs horizontally.
- End of run connector with "U" channel and bottom connecting brackets to be ordered separately.

	DESCRIPTION	PRODUCT CODE	LIST PRICE	DIMENSIONS/INCHES		
			LP	H	W	D
	Laminate Double Sided Gallery	EVLEPDS4251	692	42	51	1
	Panel - Connector Ends - 42" High	EVLEPDS4263	901	42	63	1
		EVLEPDS4275	1110	42	75	1
	Laminate Double Sided Gallery	EVLEPDS4851	754	48	51	1
	Panel - Connector Ends - 48" High	EVLEPDS4863	999	48	63	1
		EVLEPDS4875	1214	48	75	1
	Laminate Double Sided Gallery	EVLEPDS5451	875	54	51	1
	Panel - Connector Ends - 54" High	EVLEPDS5463	1143	54	63	1
		EVLEPDS5475	1322	54	75	1

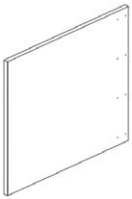
EVLEPSSNC - LAMINATE SINGLE SIDED GALLERY PANEL, FINISHED ENDS

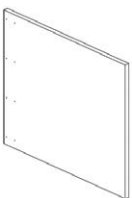

- Attaches to end of run connector with "U" channel.
- To be installed at end of panel run on one side.
- Finished in thermally fused laminate.
- No connection both sides.
- Laminate Gallery Extension Panel height is inclusive of panel glides extended to their full height.
- If wood grain is selected, grain runs horizontally.
- End of run connector with "U" channel and bottom connecting brackets to be ordered separately.

	DESCRIPTION	PRODUCT CODE	LIST PRICE LP	DIMENSIONS/INCHES		
				H	W	D
	Laminate Single Sided Gallery Panel - Finished Ends - 42" High	EVLEPSSL4227NC	450	42	27	1
		EVLEPSSL4233NC	502	42	33	1
		EVLEPSSL4239NC	564	42	39	1
		EVLEPSSL4245NC	646	42	45	1
		EVLEPSSL4251NC	692	42	51	1
	Laminate Single Sided Gallery Panel - Finished Ends - 48" High	EVLEPSSL4827NC	492	48	27	1
		EVLEPSSL4833NC	558	48	33	1
		EVLEPSSL4839NC	625	48	39	1
		EVLEPSSL4845NC	692	48	45	1
		EVLEPSSL4851NC	784	48	51	1
	Laminate Single Sided Gallery Panel - Finished Ends - 54" High	EVLEPSSL5427NC	541	54	27	1
		EVLEPSSL5433NC	618	54	33	1
		EVLEPSSL5439NC	704	54	39	1
		EVLEPSSL5445NC	824	54	45	1
		EVLEPSSL5451NC	875	54	51	1
	Laminate Single Sided Gallery Panel - Finished Ends - 42" High	EVLEPSSR4227NC	450	42	27	1
		EVLEPSSR4233NC	502	42	33	1
		EVLEPSSR4239NC	564	42	39	1
		EVLEPSSR4245NC	646	42	45	1
		EVLEPSSR4251NC	692	42	51	1
	Laminate Single Sided Gallery Panel - Finished Ends - 48" High	EVLEPSSR4827NC	492	48	27	1
		EVLEPSSR4833NC	558	48	33	1
		EVLEPSSR4839NC	625	48	39	1
		EVLEPSSR4845NC	692	48	45	1
		EVLEPSSR4851NC	784	48	51	1
	Laminate Single Sided Gallery Panel - Finished Ends - 54" High	EVLEPSSR5427NC	754	54	27	1
		EVLEPSSR5433NC	618	54	33	1
		EVLEPSSR5439NC	704	54	39	1
		EVLEPSSR5445NC	824	54	45	1
		EVLEPSSR5451NC	875	54	51	1

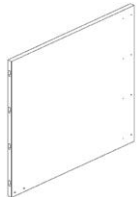
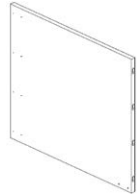

EVLEPSS - LAMINATE SINGLE SIDED GALLERY PANEL, CONNECTOR END

- Attaches to end of run connector with "U" channel.
- To be installed at end of panel run on one side.
- Finished in thermally fused laminate.
- Locking connection on one side.
- Laminate Gallery Extension Panel height is inclusive of panel glides extended to their full height.
- If wood grain is selected, grain runs horizontally.
- End of run connector with "U" channel and bottom connecting brackets to be ordered separately

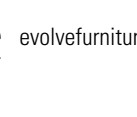
	DESCRIPTION	PRODUCT CODE	LIST PRICE	DIMENSIONS/INCHES		
			LP	H	W	D
	Laminate Single Sided Gallery Panel - Connector Ends - 42" High	EVLEPSSL4227	450	42	27	1
		EVLEPSSL4233	502	42	33	1
		EVLEPSSL4239	564	42	39	1
		EVLEPSSL4245	646	42	45	1
		EVLEPSSL4251	692	42	51	1
	Laminate Single Sided Gallery Pannel - Connector Ends - 48" High	EVLEPSSL4827	492	48	27	1
		EVLEPSSL4833	558	48	33	1
		EVLEPSSL4839	625	48	39	1
		EVLEPSSL4845	692	42	45	1
		EVLEPSSL4851	784	42	51	1
	Laminate Single Sided Gallery Pannel - Connector Ends - 54" High	EVLEPSSL5427	541	54	27	1
		EVLEPSSL5433	618	54	33	1
		EVLEPSSL5439	704	42	39	1
		EVLEPSSL5445	824	54	45	1
		EVLEPSSL5451	875	42	51	1
	Laminate Single Sided Gallery Pannel - Connector Ends - 42" High	EVLEPSSR4227	450	42	27	1
		EVLEPSSR4233	502	42	33	1
		EVLEPSSR4239	564	42	39	1
		EVLEPSSR4245	646	42	45	1
		EVLEPSSR4251	692	42	51	1
	Laminate Single Sided Gallery Pannel - Connector Ends - 48" High	EVLEPSSR4827	492	48	27	1
		EVLEPSSR4833	558	48	33	1
		EVLEPSSR4839	625	48	39	1
		EVLEPSSR4845	692	42	45	1
		EVLEPSSR4851	784	42	51	1
	Laminate Single Sided Gallery Pannel - Connector Ends - 54" High	EVLEPSSR5427	541	54	27	1
		EVLEPSSR5433	618	54	33	1
		EVLEPSSR5439	704	54	39	1
		EVLEPSSR5445	824	42	45	1
		EVLEPSSR5451	875	42	51	1

EVLEPDCNC - LAMINATE DOUBLE SIDED MIDDLE GALLERY PANEL, BASE POWER, FINISHED ENDS

- Attaches in middle of panel run with connector with "U" channel.
- To be installed in middle between two panels in straight run.
- Finished in thermally fused laminate.
- Locking connection on both side.
- Laminate Gallery Panel height is inclusive of panel glides extended to their full height.
- If wood grain is selected, grain runs horizontally.
- End of run connector with "U" channel and bottom connecting brackets to be ordered separately.

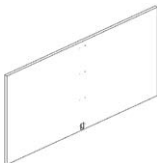
	DESCRIPTION	PRODUCT CODE	LIST PRICE LP	DIMENSIONS/INCHES		
				H	W	D
	Laminate Double Sided Gallery Panel Finished Ends - 42" High	EVLEPDC4251NC	875	42	51	1
		EVLEPDC4263NC	901	42	63	1
		EVLEPDC4275NC	1110	42	75	1
	Laminate Double Sided Gallery Panel Finished Ends - 48" High	EVLEPDC4851NC	754	48	51	1
		EVLEPDC4863NC	999	48	63	1
		EVLEPDC4875NC	1214	48	75	1
	Laminate Double Sided Gallery Panel Finished Ends - 54" High	EVLEPDC4851NC	754	54	51	1
		EVLEPDC4863NC	999	54	63	1
		EVLEPDC4875NC	1214	54	75	1

EVICLXPNC - LAMINATE DOUBLE SIDED MIDDLE GALLERY PANEL, BELTLINE POWER, FINISHED ENDS

- Attaches in middle of panel run with connector with "U" channel
- To be installed in middle between two beltline panels in straight run .
- Finished in thermally fused laminate.
- No connection both sides.
- Laminate Gallery Panel height is inclusive of panel glides extended to their full height.
- If wood grain is selected, grain runs horizontally.
- End of run connector with "U" channel and bottom connecting brackets to be ordered separately.

	DESCRIPTION	PRODUCT CODE	LIST PRICE LP	DIMENSIONS/INCHES		
				H	W	D
	Laminate Double Sided Middle Gallery Panel - Finished Ends - 42" High	EVICLXP4251NC	692	42	51	1
		EVICLXP4263NC	901	42	63	1
		EVICLXP4275NC	1110	42	75	1
	Laminate Double Sided Middle Gallery Panel - Finished Ends - 48" High	EVICLXP4851NC	754	48	51	1
		EVICLXP4863NC	999	48	63	1
		EVICLXP4875NC	1214	48	75	1
	Laminate Double Sided Middle Gallery Panel - Finished Ends - 54" High	EVICLXP5451NC	875	54	51	1
		EVICLXP5463NC	1143	54	63	1
		EVICLXP5475NC	1322	54	75	1



EVLEPDC - LAMINATE DOUBLE SIDED MIDDLE GALLERY PANEL, BASE POWER, CONNECTOR ENDS

- Attaches to end of run connector with "U" channel.
- To be installed in middle between two panels in straight run.
- Finished in thermally fused laminate.
- Locking connection both sides.
- Laminate Gallery Extension Panel height is inclusive of panel glides extended to their full height.
- If wood grain is selected, grain runs horizontally.
- End of run connector with "U" channel and bottom connecting brackets to be ordered separately.

	DESCRIPTION	PRODUCT CODE	LIST PRICE	DIMENSIONS/INCHES		
			LP	H	W	D
	Laminate Double Sided Middle Gallery Panel - Connector End - 42" High	EVLEPDC4251	692	42	51	1
		EVLEPDC4263	901	42	63	1
		EVLEPDC4275	1110	42	75	1
	Laminate Single Sided Middle Gallery Panel - Connector End - 48" High	EVLEPDC4851	754	48	51	1
		EVLEPDC4863	999	48	63	1
		EVLEPDC4875	1214	48	75	1
	Laminate Single Sided Middle Gallery Panel - Connector End - 54" High	EVLEPDC5451	875	54	51	1
		EVLEPDC5463	1143	54	63	1
		EVLEPDC5475	1322	54	75	1

EVICLXP - LAMINATE DOUBLE SIDED MIDDLE GALLERY PANEL, BELTLINE POWER, CONNECTOR ENDS

- Attaches in middle of panel run with connector with "U" channel.
- To be installed in middle between two panels in straight run on one side.
- Finished in thermally fused laminate.
- Locking connection on both sides.
- Laminate Gallery Panel height is inclusive of panel glides extended to their full height.
- If wood grain is selected, grain runs horizontally.
- End of run connector with "U" channel and bottom connecting brackets to be ordered separately.

	DESCRIPTION	PRODUCT CODE	LIST PRICE	DIMENSIONS/INCHES		
			LP	H	W	D
	Laminate Double Sided Gallery Panel Connector Ends - 42" High	EVICLXP4251	692	42	51	1
		EVICLXP4263	901	42	63	1
		EVICLXP4275	1110	42	75	1
	Laminate Double Sided Gallery Panel Connector Ends - 42" High	EVICLXP4851	754	48	51	1
		EVICLXP4863	999	48	63	1
		EVICLXP4875	1214	48	75	1
	Laminate Double Sided Gallery Panel Connector Ends - 42" High	EVICLXP5451	875	54	51	1
		EVICLXP5463	1143	54	63	1
		EVICLXP5475	1322	42	75	1

EVLEPSCNC - LAMINATE SINGLE SIDED MIDDLE GALLERY PANEL, BASE POWER, FINISHED ENDS

- Attaches in middle of panel run with connector with "U" channel.
- To be installed in middle between two panels in straight run on one side.
- Cut out for electrics at base height.
- Finished in thermally fused laminate.
- No connection both sides.
- Laminate Gallery Panel height is inclusive of panel glides extended to their full height.
- If wood grain is selected, grain runs horizontally.
- End of run connector with "U" channel and bottom connecting brackets to be ordered separately.

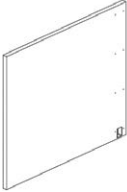
	DESCRIPTION	PRODUCT CODE	LIST PRICE LP	DIMENSIONS/INCHES		
				H	W	D
	Laminate Single Sided Gallery Panel - Finished End - 42" High	EVLEPSC4227NC	450	42	27	1
		EVLEPSC4233NC	502	42	33	1
		EVLEPSC4239NC	564	42	39	1
		EVLEPSC4245NC	646	42	45	1
		EVLEPSC4251NC	692	42	51	1
	Laminate Single Sided Gallery Panel - Finished End - 48" High	EVLEPSC4827NC	492	48	27	1
		EVLEPSC4833NC	558	48	33	1
		EVLEPSC4839NC	625	48	39	1
		EVLEPSC4845NC	692	48	45	1
		EVLEPSC4851NC	784	48	51	1
	Laminate Single Sided Gallery Panel - Finished End - 54" High	EVLEPSC5427NC	541	54	27	1
		EVLEPSC5433NC	618	54	33	1
		EVLEPSC5439NC	704	54	39	1
		EVLEPSC5445NC	824	54	45	1
		EVLEPSC5451NC	875	54	51	1

EVLEPSC - LAMINATE SINGLE SIDED MIDDLE GALLERY PANEL, BASE POWER, CONNECTOR END

- Attaches in middle of panel run with connector with "U" channel.
- To be installed in middle between two panels in straight run on one side.
- Finished in thermally fused laminate.
- Locking connection on one side.
- Laminate Gallery Panel height is inclusive of panel glides extended to their full height.
- If wood grain is selected, grain runs horizontally.
- End of run connector with "U" channel and bottom connecting brackets to be ordered separately.

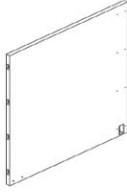
	DESCRIPTION	PRODUCT CODE	LIST PRICE LP	DIMENSIONS/INCHES		
				H	W	D
	Laminate Single Sided Middle Gallery Panel - Connector Ends - 42" High	EVLEPSC4227	450	42	27	1
		EVLEPSC4233	502	42	33	1
		EVLEPSC4239	564	42	39	1
		EVLEPSC4245	646	42	45	1
		EVLEPSC4251	692	42	51	1
	Laminate Single Sided Middle Gallery Panel - Connector Ends - 48" High	EVLEPSC4827	492	48	27	1
		EVLEPSC4833	558	48	33	1
		EVLEPSC4839	625	48	39	1
		EVLEPSC4845	692	42	45	1
		EVLEPSC4851	784	42	51	1
	Laminate Single Sided Middle Gallery Panel - Connector Ends - 54" High	EVLEPSC5427	541	54	27	1
		EVLEPSC5433	618	54	33	1
		EVLEPSC5439	704	42	39	1
		EVLEPSC5445	824	54	45	1
		EVLEPSC5451	875	42	51	1



EVLEPSCNC - LAMINATE SINGLE SIDED MIDDLE GALLERY PANEL, BELTLINE POWER, FINISHED ENDS

- Attaches in middle of panel run with connector with “U” channel.
- To be installed in middle between two beltline panels in straight run.
- Cut out for electrics at beltline height.
- Finished in thermally fused laminate.
- No connection both sides.
- Laminate Gallery Panel height is inclusive of panel glides extended to their full height.
- If wood grain is selected, grain runs horizontally.
- End of run connector with “U” channel and bottom connecting brackets to be ordered separately.

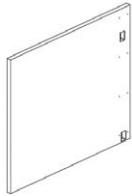
	DESCRIPTION	PRODUCT CODE	LIST PRICE	DIMENSIONS/INCHES		
			LP	H	W	D
	Laminate Single Sided Gallery Panel Finished Ends - 42” High	EVLEPSCB4227NC	450	42	27	1
		EVLEPSCB4233NC	502	42	33	1
		EVLEPSCB4239NC	564	42	39	1
		EVLEPSCB4245NC	692	42	45	1
		EVLEPSCB4251NC	692	42	51	1
	Laminate Single Sided Gallery Panel Finished Ends - 48” High	EVLEPSCB4827NC	492	48	27	1
		EVLEPSCB4833NC	558	48	33	1
		EVLEPSCB4839NC	625	48	39	1
		EVLEPSCB4845NC	692	48	45	1
		EVLEPSCB4851NC	784	48	51	1
	Laminate Single Sided Gallery Panel Finished Ends - 54” High	EVLEPSCB5427NC	541	54	27	1
		EVLEPSCB5433NC	618	54	33	1
		EVLEPSCB5439NC	704	54	39	1
		EVLEPSCB5445NC	824	54	45	1
		EVLEPSCB5451NC	875	54	51	1

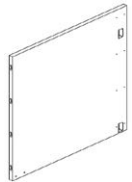

EVLEPSC - LAMINATE SINGLE SIDED MIDDLE GALLERY PANEL, BELTLINE POWER, CONNECTOR END

- Attaches in middle of panel run with connector with “U” channel.
- To be installed in middle between two panels in straight run on one side.
- Finished in thermally fused laminate.
- Locking connection on one side.
- Laminate Gallery Panel height is inclusive of panel glides extended to their full height.
- If wood grain is selected, grain runs horizontally.
- End of run connector with “U” channel and bottom connecting brackets to be ordered separately.

	DESCRIPTION	PRODUCT CODE	LIST PRICE	DIMENSIONS/INCHES		
			LP	H	W	D
	Laminate Single Sided Middle Gallery Panel - Connector Ends - 42” High	EVLEPSCB4227	450	42	27	1
		EVLEPSCB4233	502	42	33	1
		EVLEPSCB4239	564	42	39	1
		EVLEPSCB4245	646	42	45	1
		EVLEPSCB4251	692	42	51	1
	Laminate Single Sided Middle Gallery Panel - Connector Ends - 48” High	EVLEPSCB4827	492	48	27	1
		EVLEPSCB4833	558	48	33	1
		EVLEPSCB4839	625	48	39	1
		EVLEPSCB4845	692	48	45	1
		EVLEPSCB4851	784	48	51	1
	Laminate Single Sided Middle Gallery Panel - Connector Ends - 54” High	EVLEPSCB5427	541	54	27	1
		EVLEPSCB5433	618	54	33	1
		EVLEPSCB5439	704	54	39	1
		EVLEPSCB5445	824	54	45	1
		EVLEPSCB5451	875	42	51	1

EVLXPMNC - LAMINATE GALLERY EXTENSION PANEL, FINISHED END



- Locking connection on one side, no connection at end.
- Finished in thermally fused laminate.
- Laminate Gallery Extension Panel height is inclusive of panel glides extended to their full height.
- If wood grain is selected, grain runs horizontally.
- Bottom connecting brackets to be ordered separately.

	DESCRIPTION	PRODUCT CODE	LIST PRICE LP	DIMENSIONS/INCHES		
				H	W	D
	Laminate Gallery Extension Panel	EVLXPMML4224NC	369	42	24	1
	Finished End - 42" High	EVLXPMML4230NC	450	42	30	1
		EVLXPMML4236NC	502	42	36	1
		EVLXPMML4242NC	563	42	42	1
		EVLXPMML4248NC	645	42	48	1
	Laminate Gallery Extension Panel	EVLXPMML4824NC	424	48	24	1
	Finished End - 48" High	EVLXPMML4830NC	492	48	30	1
		EVLXPMML4836NC	558	48	36	1
		EVLXPMML4842NC	625	48	42	1
		EVLXPMML4848NC	692	48	48	1
	Laminate Gallery Extension Panel	EVLXPMML5424NC	754	54	24	1
	Finished End - 54" High	EVLXPMML5430NC	541	54	30	1
		EVLXPMML5436NC	618	54	36	1
		EVLXPMML5442NC	704	54	42	1
		EVLXPMML5448NC	824	54	48	1
	Laminate Gallery Extension Panel	EVLXPMR4224NC	369	42	24	1
	Finished End - 42" High	EVLXPMR4230NC	450	42	30	1
		EVLXPMR4236NC	502	42	36	1
		EVLXPMR4242NC	563	42	42	1
		EVLXPMR4248NC	645	42	48	1
	Laminate Gallery Extension Panel	EVLXPMR4824NC	424	48	24	1
	Finished End - 48" High	EVLXPMR4830NC	492	48	30	1
		EVLXPMR4836NC	558	48	36	1
		EVLXPMR4842NC	625	48	42	1
		EVLXPMR4848NC	692	48	48	1
	Laminate Gallery Extension Panel	EVLXPMR5424NC	462	54	24	1
	Finished End - 54" High	EVLXPMR5430NC	541	54	30	1
		EVLXPMR5436NC	618	54	36	1
		EVLXPMR5442NC	704	54	42	1
		EVLXPMR5448NC	824	54	48	1





EVLXPM - LAMINATE GALLERY STRAIGHT EXTENSION PANEL, CONNECTOR ENDS

- Locking connection both sides.
- Finished in thermally fused laminate.
- Laminate Gallery Panel height is inclusive of panel glides extended to their full height.
- If wood grain is selected, grain runs horizontally.
- Bottom connecting brackets to be ordered separately.

	DESCRIPTION	PRODUCT CODE	LIST PRICE LP	DIMENSIONS/INCHES		
				H	W	D
	Laminate Gallery Straight Extension	EVLXPML4224	692	42	24	1
	Panel - Connector Ends - Left - 42" High	EVLXPML4230	450	42	30	1
		EVLXPML4236	502	42	36	1
		EVLXPML4242	563	42	42	1
		EVLXPML4248	645	42	48	1
	Laminate Gallery Straight Extension	EVLXPML4824	424	48	24	1
	Panel - Connector Ends - Left - 48" High	EVLXPML4830	492	48	30	1
		EVLXPML4836	558	48	36	1
		EVLXPML4842	625	48	42	1
		EVLXPML4848	692	48	48	1
	Laminate Gallery Straight Extension	EVLXPML5424	462	54	24	1
	Panel - Connector Ends - Left - 54" High	EVLXPML5430	541	54	30	1
		EVLXPML5436	618	54	36	1
		EVLXPML5442	704	54	42	1
		EVLXPML5448	824	54	48	1
	Laminate Gallery Straight Extension	EVLXPMR4224	369	42	24	1
	Panel - Connector Ends - Right - 42" High	EVLXPMR4230	450	42	30	1
		EVLXPMR4236	502	42	36	1
		EVLXPMR4242	563	42	42	1
		EVLXPMR4248	645	42	48	1
	Laminate Gallery Straight Extension	EVLXPMR4824	424	48	24	1
	Panel - Connector Ends - Right - 48" High	EVLXPMR4830	492	48	30	1
		EVLXPMR4836	558	48	36	1
		EVLXPMR4842	625	48	42	1
		EVLXPMR4848	692	48	48	1
	Laminate Gallery Straight Extension	EVLXPMR5424	462	54	24	1
	Panel - Connector Ends - Right - 54" High	EVLXPMR5430	541	54	30	1
		EVLXPMR5436	618	54	36	1
		EVLXPMR5442	704	54	42	1
		EVLXPMR5448	824	54	48	1

EV2LXP - LAMINATE GALLERY TWO-WAY EXTENSION PANEL, FINISHED ENDS

- Panel connects at 90 degree with extension panel.
- Finished in thermally fused laminate.
- Laminate Gallery Extension Panel height is inclusive of panel glides extended to their full height.
- If wood grain is selected, grain runs horizontally.
- Corner connecting brackets to be ordered separately.

	DESCRIPTION	PRODUCT CODE	LIST PRICE LP	DIMENSIONS/INCHES		
				H	W	D
	Laminate Gallery Two-Way Extension Panel - Finished Ends - Left - 42" High	EV2LXPL4225	371	42	25	1
		EV2LXPL4231	450	42	31	1
		EV2LXPL4237	502	42	37	1
		EV2LXPL4243	564	42	43	1
		EV2LXPL4249	646	42	49	1
	Laminate Gallery Two-Way Extension Panel - Finished Ends - Left - 48" High	EV2LXPL4825	424	48	25	1
		EV2LXPL4831	492	48	31	1
		EV2LXPL4837	558	48	37	1
		EV2LXPL4843	625	48	43	1
		EV2LXPL4849	692	48	49	1
	Laminate Gallery Two-Way Extension Panel - Finished Ends - Left - 54" High	EV2LXPL5425	497	54	25	1
		EV2LXPL5431	568	54	31	1
		EV2LXPL5437	638	54	37	1
		EV2LXPL5443	776	54	43	1
		EV2LXPL5449	875	54	49	1
	Laminate Gallery Two-Way Extension Panel - Finished Ends - Right - 42" High	EV2LXPR4225	371	42	25	1
		EV2LXPR4231	450	42	33	1
		EV2LXPR4237	502	42	37	1
		EV2LXPR4243	564	42	43	1
		EV2LXPR4249	646	42	49	1
	Laminate Gallery Two-Way Extension Panel - Finished Ends - Right - 48" High	EV2LXPR4825	424	48	25	1
		EV2LXPR4831	492	48	33	1
		EV2LXPR4837	558	48	37	1
		EV2LXPR4843	625	48	43	1
		EV2LXPR4849	692	48	49	1
	Laminate Gallery Two-Way Extension Panel - Finished Ends - Right - 54" High	EV2LXPR5425	497	54	25	1
		EV2LXPR5431	568	54	31	1
		EV2LXPR5437	638	54	37	1
		EV2LXPR5443	776	54	43	1
		EV2LXPR5449	875	54	49	1



EV3LXP - LAMINATE GALLERY THREE-WAY EXTENSION PANEL, FINISHED ENDS

- Panel connects "T" configuration with extension panel.
- Finished in thermally fused laminate.
- Laminate Gallery Extension Panel height is inclusive of panel glides extended to their full height.
- If wood grain is selected, grain runs horizontally.
- Corner connecting brackets to be ordered separately.

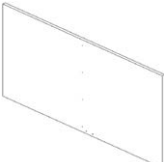
	DESCRIPTION	PRODUCT CODE	LIST PRICE LP	DIMENSIONS/INCHES		
				H	W	D
	Laminate Gallery Three-Way Extension Panel - Finished Ends - Left - 42" High	EV3LXPL4249	692	42	49	1
		EV3LXPL4261	824	42	61	1
		EV3LXPL4273	959	42	73	1
	Laminate Gallery Three-Way Extension Panel - Finished Ends - Left - 48" High	EV3LXPL4849	784	48	49	1
		EV3LXPL4861	963	48	61	1
		EV3LXPL4873	1143	48	73	1
	Laminate Gallery Three-Way Extension Panel - Finished Ends - Left - 54" High	EV3LXPL5449	875	54	49	1
		EV3LXPL5461	1143	54	61	1
		EV3LXPL5473	1322	54	73	1
	Laminate Gallery Three-Way Extension Panel - Finished Ends - Left - 42" High	EV3LXPR4249	692	42	49	1
		EV3LXPR4261	824	42	61	1
		EV3LXPR4273	959	42	73	1
	Laminate Gallery Three-Way Extension Panel - Finished Ends - Left - 48" High	EV3LXPR4849	784	48	49	1
		EV3LXPR4861	963	48	61	1
		EV3LXPR4873	1143	48	73	1
	Laminate Gallery Three-Way Extension Panel - Finished Ends - Left - 54" High	EV3LXPR5449	875	54	49	1
		EV3LXPR5461	1143	54	61	1
		EV3LXPR5473	1322	54	73	1

EV4LXP - LAMINATE DOUBLE GALLERY PANEL FOR FOUR-WAY, FINISHED ENDS

- Panel connects "+" configuration with extension panel.
- Finished in thermally fused laminate.
- Laminate Gallery Extension Panel height is inclusive of panel glides extended to their full height.
- If wood grain is selected, grain runs horizontally.
- Corner connecting brackets to be ordered separately

	DESCRIPTION	PRODUCT CODE	LIST PRICE LP	DIMENSIONS/INCHES		
				H	W	D
	Laminate Double Gallery Panel	EV4LXP4249	692	42	49	1
	Four-Way - Finished Ends - 42" High	EV4LXP4261	901	42	61	1
		EV4LXP4273	1110	42	73	1
	Laminate Double Gallery Panel	EV4LXP4849	754	48	49	1
	Four-Way - Finished Ends - 48" High	EV4LXP4861	999	48	61	1
		EV4LXP4873	1214	48	73	1
	Laminate Double Gallery Panel	EV4LXP5449	875	54	49	1
	Four-Way - Finished Ends - 48" High	EV4LXP5461	1143	54	61	1
		EV4LXP5473	1322	54	73	1

EV4LXPM - LAMINATE GALLERY EXTENSION PANEL FOR FOUR-WAY CONFIGURATION, FINISHED ENDS

- Locking connection on one side only for four way panel.
- Finished in thermally fused laminate.
- Universal to be used on both sides of four way laminate panel.
- Laminate Gallery Extension Panel height is inclusive of panel glides extended to their full height.
- If wood grain is selected, grain runs horizontally.
- Bottom connecting brackets to be ordered separately.

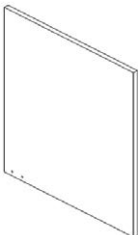
	DESCRIPTION	PRODUCT CODE	LIST PRICE LP	DIMENSIONS/INCHES		
				H	W	D
	Laminate Gallery Extension Panel	EV4LXPM4224	369	42	24	1
	Four-Way - Finished Ends - 42" High	EV4LXPM4230	450	42	30	1
		EV4LXPM4236	502	42	36	1
		EV4LXPM4242	563	42	42	1
		EV4LXPM4248	645	42	58	1
	Laminate Gallery Extension Panel	EV4LXPM4824	424	48	24	1
	Four-Way - Finished Ends - 42" High	EV4LXPM4830	492	48	30	1
		EV4LXPM4836	558	48	36	1
		EV4LXPM4842	625	48	42	1
		EV4LXPM4848	692	48	48	1
	Laminate Gallery Extension Panel	EV4LXPM5424	462	54	24	1
	Four-Way - Finished Ends - 42" High	EV4LXPM5430	541	54	30	1
		EV4LXPM5436	618	54	36	1
		EV4LXPM5442	704	54	42	1
		EV4LXPM5448	824	54	48	1



EVERPERCH - EVOLVE PANEL CONNECTOR WITH U CHANNEL

- U channel attaches with screws to laminate end panel or laminate middle panel.
- Evolve panels attaches to connector.
- Pass thru at bottom and beltline location for power/data.
- U channel is welded to connector.
- Includes connector with U channel and hardware.

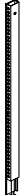
	DESCRIPTION	PRODUCT CODE	LIST PRICE	DIMENSIONS/INCHES		
			LP	H	W	D
	Panel Connector	EVERPERCH42	172	42	2.875	1
	U Channel	EVERPERCH48	185	48	2.875	1
		EVERPERCH54	200	54	2.875	1

EVPBERCH - EVOLVE PANEL CONNECTOR WITH U CHANNEL FOR BELTLINE PANELS

- U channel attaches with screws to laminate middle panel.
- Evolve panels attaches to connector.
- Pass thru at bottom and beltline location for power/data.
- U channel is welded to connector.
- Includes connector with U channel and hardware.

	DESCRIPTION	PRODUCT CODE	LIST PRICE	DIMENSIONS/INCHES		
			LP	H	W	D
	Panel Connector	EVPBERCH42	172	42	2.875	1
	U Channel	EVPBERCH48	185	48	2.875	1
		EVPBERCH54	200	54	2.875	1

EVERPERCHNR - NO RACEWAY PANEL CONNECTOR WITH U CHANNEL

- U channel attaches with screws to laminate end panel or laminate middle panel.
- Evolve NR panels attaches to connector.
- U channel is welded to NR connector.
- Includes NR connector with U channel and hardware.

	DESCRIPTION	PRODUCT CODE	LIST PRICE	DIMENSIONS/INCHES		
			LP	H	W	D
	No Raceway Connector with U Channel	EVERPERCH42NR	172	42	2.875	1
		EVERPERCH48NR	185	48	2.875	1
		EVERPERCH54NR	200	54	2.875	1

EVPGDCP - GALLERY PANEL DATA POST / COMM LAY-IN

- One way post attaches to Gallery Panel at the end to bring power and/or data cables from ceiling to Evolve panels.
- Accommodates up to 25 CAT 5 cables with electric. Accommodates up to 45 CAT 5 cables without electric.
- Middle Gallery panel with bottom cut out for electric must be ordered.
- Standard data post extension used above.
- Standard data post extension to be ordered separately.

	DESCRIPTION	PRODUCT CODE	LIST PRICE	DIMENSIONS/INCHES		
			LP	H	W	D
	Data Post	EVPGDCP42	230	42	3	
		EVPGDCP48	270	48	3	
		EVPGDCP54	295	54	3	

EVHLPBB01 - LAMINATE GALLERY PANEL BOTTOM BRACKET

- Laminate panel bottom bracket connects two laminate end panels at bottom with screws. • Bracket and screws included
- Available in standard paint colors.

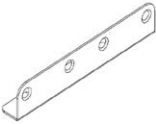
DESCRIPTION	PRODUCT CODE	LIST PRICE LP	DIMENSIONS/INCHES		
			H	W	D
 Bottom Bracket	EVHLPBB01	47	1.5	8	1

EVHLPB01 - LAMINATE GALLERY PANEL CORNER BRACKET

- Laminate panel corner bottom bracket connects two laminate panels at 90 degree. • Bracket and screws included.
- Available in standard paint colors.

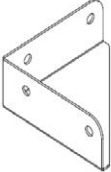
DESCRIPTION	PRODUCT CODE	LIST PRICE LP	DIMENSIONS/INCHES		
			H	W	D
 Corner Bracket	EVHLPB01	46	1.5	4	4

EVPTTAU - EVOLVE CONNECTOR WITH U CHANNEL TOP TRIM ALUMINUM

- Aluminum top trim longer by 0.625" to cover width of connector with U channel. • Available in standard paint colors.
- Trim can not span a post.

DESCRIPTION	PRODUCT CODE	LIST PRICE LP	DIMENSIONS/INCHES		
			H	W	D
 Top Trim Aluminum	EVPTTAU24	25	1	24.625	1
	EVPTTAU30	27	1	30.625	1
	EVPTTAU36	30	1	36.625	1
	EVPTTAU42	35	1	42.625	1
	EVPTTAU48	48	1	48.625	1
	EVPTTAU54	54	1	54.625	1
	EVPTTAU60	59	1	60.625	1
	EVPTTAU66	65	1	66.625	1
	EVPTTAU72	73	1	72.625	1
	EVPTTAU78	81	1	78.625	1
EVPTTAU84	86	1	84.625	1	



EVLEP - 1" LAMINATE END PANEL

- 1" Laminate End Panel attaches to an end of run connector.
- Left Hand or Right Hand available.
- Finished in thermally Fused Laminate.
- Includes threaded metal inserts and support brackets to attach a worksurface on one side.
- 1" Laminate end panel have panel leveling glides.
- If wood grain is selected, grain runs vertically.

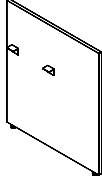
	DESCRIPTION	PRODUCT CODE	LIST PRICE LP	DIMENSIONS/INCHES		
				H	W	D
	1" Laminate End Panel - Right - 42" High	EVLEPR4224	376	42	24	1
		EVLEPR4230	470	42	30	1
		EVLEPR4236	563	42	36	1
		EVLEPR4242	656	42	42	1
		EVLEPR4248	750	42	48	1
	1" Laminate End Panel - Left - 42" High	EVLEPL4224	376	42	24	1
		EVLEPL4230	470	42	30	1
		EVLEPL4236	563	42	36	1
		EVLEPL4242	656	42	42	1
		EVLEPL4248	750	42	48	1
	1" Laminate End Panel - Right - 48" High	EVLEPR4824	424	48	24	1
		EVLEPR4830	537	48	30	1
		EVLEPR4836	644	48	36	1
		EVLEPR4842	747	48	42	1
		EVLEPR4848	857	48	48	1
	1" Laminate End Panel - Left - 48" High	EVLEPL4824	424	48	24	1
		EVLEPL4830	537	48	30	1
		EVLEPL4836	644	48	36	1
		EVLEPL4842	747	48	42	1
		EVLEPL4848	857	48	48	1

EVLMP - 1" LAMINATE MIDDLE PANEL

- 1" Laminate Middle Panel attaches to a double inline connector.
- Finished in thermally Fused Laminate.
- Includes threaded metal inserts and support brackets to attach worksurfaces on both sides.
- 1" Laminate middle panel has panel leveling glides.
- If wood grain is selected, grain runs vertically.

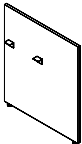
	DESCRIPTION	PRODUCT CODE	LIST PRICE LP	DIMENSIONS/INCHES		
				H	W	D
	1" Laminate Middle Panel - 42" High	EVLMP4224	420	42	24	1
		EVLMP4230	511	42	30	1
		EVLMP4236	605	42	36	1
		EVLMP4242	703	42	42	1
		EVLMP4248	845	42	48	1
	1" Laminate Middle Panel - 48" High	EVLMP4824	469	48	24	1
		EVLMP4830	578	48	30	1
		EVLMP4836	685	48	36	1
		EVLMP4842	794	48	42	1
		EVLMP4848	901	48	48	1

EVLEPXXYYA - 1" LAMINATE END PANEL WITH ACCESSORY RAIL

- 1" Laminate End Panel attaches to an end of run connector.
- Includes accessory rail.
- Accessories can be used on accessory rail. Please see accessory section for additional details.
- Finished in thermally Fused Laminate.
- Includes threaded metal inserts and support brackets to attach a worksurface on one side.
- 1" Laminate end panel have panel leveling glides.
- If wood grain is selected, grain runs vertically.

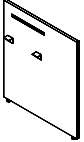
	DESCRIPTION	PRODUCT CODE	LIST PRICE LP	DIMENSIONS/INCHES		
				H	W	D
	1" Laminate End Panel with Accessory Rail - Right - 42" High	EVLEPR4224A	425	42	24	1
		EVLEPR4230A	517	42	30	1
		EVLEPR4236A	613	42	36	1
		EVLEPR4242A	710	42	42	1
		EVLEPR4248A	808	42	48	1
	1" Laminate End Panel with Accessory Rail - Left - 42" High	EVLEPL4224A	425	42	24	1
		EVLEPL4230A	517	42	30	1
		EVLEPL4236A	613	42	36	1
		EVLEPL4242A	710	42	42	1
		EVLEPL4248A	808	42	48	1
1" Laminate End Panel with Accessory Rail - Right - 48" High	EVLEPR4824A	476	48	24	1	
	EVLEPR4830A	576	48	30	1	
	EVLEPR4836A	649	48	36	1	
	EVLEPR4842A	744	48	42	1	
	EVLEPR4848A	910	48	48	1	
1" Laminate End Panel with Accessory Rail - Left - 48" High	EVLEPL4824A	476	48	24	1	
	EVLEPL4830A	576	48	30	1	
	EVLEPL4836A	649	48	36	1	
	EVLEPL4842A	744	48	42	1	
	EVLEPL4848A	910	48	48	1	

EVLMPXXYYA - 1" LAMINATE MIDDLE PANEL WITH ACCESSORY RAIL

- 1" Laminate Middle Panel attaches to a double inline connector.
- Includes accessory rail.
- Accessories can be used on accessory rail. Please see accessory section for additional details.
- Finished in thermally Fused Laminate.
- Includes threaded metal inserts and support brackets to attach a worksurface on one side.
- 1" Laminate middle panel has panel leveling glides.
- If wood grain is selected, grain runs vertically.

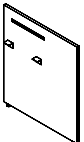
	DESCRIPTION	PRODUCT CODE	LIST PRICE LP	DIMENSIONS/INCHES		
				H	W	D
	1" Laminate Middle Panel with Accessory Rail - 42" High	EVLMP4224A	479	42	24	1
		EVLMP4230A	574	42	30	1
		EVLMP4236A	674	42	36	1
		EVLMP4242A	766	42	42	1
		EVLMP4248A	865	42	48	1
	1" Laminate Middle Panel with Accessory Rail - 48" High	EVLMP4824A	528	48	24	1
		EVLMP4830A	644	48	30	1
		EVLMP4836A	747	48	36	1
		EVLMP4842A	857	48	42	1
		EVLMP4848A	965	48	48	1



EVPDIC - DOUBLE INLINE PANEL CONNECTOR

- Used to connect 1" laminate middle panel to panels of equal height in a straight run.
- Aluminum top trim for double inline connector must be used.
- Provides slotted support for worksurfaces and hardware support.
- Includes two slotted posts with leveling glides and connection hardware.
- Use 17" flexible mesh jumper cable to pass-through panels.

DESCRIPTION	PRODUCT CODE	LIST PRICE	DIMENSIONS/INCHES		
			H	W	D
Double Inline Panel Connector	EVPDIC42	168	42	2	
	EVPDIC48	178	48	2	

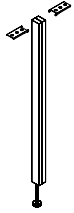

EVPBIC - BELTLINE DOUBLE INLINE PANEL CONNECTOR

- Used to connect 1" laminate middle panel to panels of equal height in a straight run.
- Use in-between beltline panels.
- Aluminum top trim for double inline connector must be used.
- Provides slotted support for worksurfaces and hardware support.
- Includes two slotted posts with leveling glides and connection hardware.
- Use 17" flexible mesh jumper cable to pass-through panels.

DESCRIPTION	PRODUCT CODE	LIST PRICE	DIMENSIONS/INCHES		
			H	W	D
Beltline Double Inline Panel Connector	EVPBIC42	168	42	2	
	EVPBIC48	178	48	2	

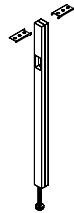

EVPDVTF - DOUBLE INLINE CONNECTOR TRIM

- Attaches to exposed side of double inline connector.

	DESCRIPTION	PRODUCT CODE	LIST PRICE	DIMENSIONS/INCHES		
				H	W	D
	Double Inline Connector Trim	EVPDVTF42	21	42		
		EVPDVTF48	27	48		

EVPTTA - DOUBLE INLINE PANEL CONNECTOR TOP TRIM - ALUMINUM

- Aluminum top trim is longer by 1.125" to cover width of panel and double inline connector.
- Trim cannot span a post connector.
- Available in standard and premium paint colors.

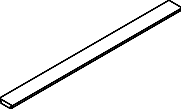
	DESCRIPTION	PRODUCT CODE	LIST PRICE	DIMENSIONS/INCHES		
				H	W	D
	Double Inline Connector Trim - Aluminum	EVPTTA25	25	25		
		EVPTTA31	27	31		
		EVPTTA37	21	37		
		EVPTTA43	35	43		
		EVPTTA49	48	49		
		EVPTTA55	54	55		
		EVPTTA61	59	61		
		EVPTTA67	65	67		
		EVPTTA73	73	73		
		EVPTTA79	81	79		
	EVPTTA85	86	83			



EV PDS - DOOR PANEL - SOLID

- All door surfaces are high pressure laminate.
- HP Laminate finish available in all standard Evolve colors.
- Two panel widths: 36" or 42" High.
- 84" Door Panel height = 66"H panel plus one 18"H Panel Extension Module.
- 90" Door Panel height = 66" H panel plus one 24"H or two 12"H Panel Extension Modules.
- Door and door trim can be specified left- or right-handed (see diagram).
- Handedness of Door Panel can be changed in the field.
- Select door frame color from standard trim colors.
- Door Sizes:
 - 36"W Door is 33.63"W without frame (This door is not ADA compliant)
 - 42"W Door is 39.63"W without frame
 - 84"H Door is 81.5"H without frame
 - 90"H Door is 87.5"H without frame
- If laminate is selected in a wood grain, the grain runs vertical.
- Customer is responsible to confirm and meet all city, county or any other municipality codes in relation to door clearances.
- Knob or lever to be ordered separately

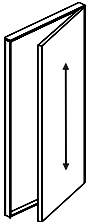
	DESCRIPTION	PRODUCT CODE	LIST PRICE		DIMENSIONS/INCHES		
			CLR	FRST	H	W	D
	Door Panel - Solid - 84" High x 36" Wide	EVPDS8436L	2859		84	36	2 7/8
		EVPDS8436R	2859		84	36	2 7/8
	Door Panel - Solid - 84" High x 42" Wide	EVPDS8442L	3309		84	42	2 7/8
		EVPDS8442R	3309		84	42	2 7/8
	Door Panel - Solid - 90" High x 36" Wide	EVPDS9036L	2859		90	36	2 7/8
		EVPDS9036R	2859		90	36	2 7/8
	Door Panel - Solid - 90" High x 42" Wide	EVPDS9042L	3309		90	42	2 7/8
		EVPDS9042R	3309		90	42	2 7/8

EV PDG- FULL GLAZED DOOR PANEL

- All door surfaces are high pressure laminate with window.
- HP laminate finish available in all standard Evolve colors.
- Two panels width 36" or 42"
- 84" Door panel height = 66"H panel and 18" H Panel Extension Modules.
- 90" Door panel height = 66"H panel and 24" H or two 12" H Panel extension modules.
- Door and door trim can be specified left or right handed (see diagram).
- Handedness of Door can be changed in field.
- Select frame color from standard trim colors.
- Door Sizes:
 - 36"W Door is 33.63"W without frame (This door is not ADA compliant)
 - 42"W Door is 39.63"W without frame
 - 84"H Door is 81.5"H without frame
 - 90"H Door is 87.5"H without frame
- If laminate is selected in wood grain, the grain runs vertical.
- Customer is responsible to confirm and meet, city, county or any other municipality codes in relation to door clearances
- Knob or lever to be ordered separately

	DESCRIPTION	PRODUCT CODE	LIST PRICE		DIMENSIONS/INCHES		
			CLR	FRST	H	W	D
	Door Panel - Glazed - 84" High x 36" Wide	EVPDG8436L	3212	3340	84	36	2 7/8
		EVPDG8436R	3212	3340	84	36	2 7/8
	Door Panel - Glazed - 84" High x 42" Wide	EVPDG8442L	3661	3789	84	42	2 7/8
		EVPDG8442R	3661	3789	84	42	2 7/8
	Door Panel - Glazed - 90" High x 36" Wide	EVPDG9036L	3212	3340	90	36	2 7/8
		EVPDG9036R	3212	3340	90	36	2 7/8
	Door Panel - Glazed - 90" High x 42" Wide	EVPDG9042L	3661	3790	90	42	2 7/8
		EVPDG9042R	3661	3790	90	42	2 7/8

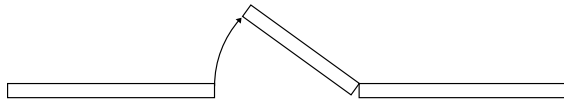

Right Hand Hung Door

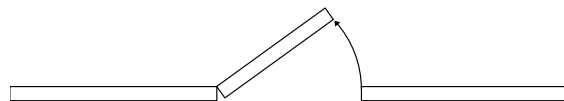

Left Hand Hung Door

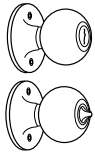

Knob Lock Set
(Knob Lock Set is not ADA compliant)
Lock set sold separately from doors.
Specific core #'s and Master Key not available

EVPSL01 119



Lever Lock Set
Lock set sold separately from doors.
Specific core #'s and Master Key not available

EVPSL02 163

EVHLPF01 - LOW PROFILE FOOT

- Used to provide additional support to panel run without adding panels
- Connects to inline connector or end of run at base of panels

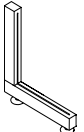
DESCRIPTION	PRODUCT CODE	LIST PRICE	DIMENSIONS/INCHES		
			H	W	D
 <p>Low Profile Foot</p>	EVHLPF01	129	11	1	11

EVPSL/R - SLIDING PRIVACY DOOR

- Sliding Privacy Door attaches to Evolve Panels using standard connectors to add privacy. Brackets that attach to Connectors are included.
- This door must mount on panels of equal width. It is also intended to be used for openings of equal width.
- Left (L) or right-handedness (R) is determined by the direction of door movement (from compressed to expanded position), while facing the door on the panel mounted side.
- Painted frame may match any Evolve Standard Paint Finish. The door interior is standard with a louvered acrylic finish.
- Telescoping arms eliminate the need for thresholds, wheels or casters.
- 81" H door must connect to panels 84" or higher.
- Thickness of louvered acrylic is 6 mm.

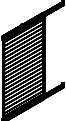
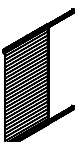
DESCRIPTION	PRODUCT CODE	LIST PRICE	DIMENSIONS/INCHES		
			H	W	D
 <p>Sliding Privacy Door - 66" High</p>	EVPSL6636R	3217	66	36	3
	EVPSL6636L	3217	66	36	3
	EVPSL6642R	3300	66	42	3
	EVPSL6642L	3300	66	42	3
 <p>Sliding Privacy Door - 81" High</p>	EVPSL8136R	3397	81	36	3
	EVPSL8136L	3397	81	36	3
	EVPSL8142R	3647	81	42	3
	EVPSL8142L	3647	81	42	3



EVPSLLOCK - SLIDING DOOR LOCK

- Lock bracket attaches to sliding door with screws.
- Includes strike plate bracket which attaches to slots in connector.
- Lock included.
- Lock sets sold separately from sliding doors.
- Available in Tungsten only.

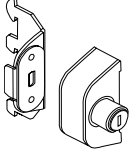
	DESCRIPTION	PRODUCT CODE	LIST PRICE	DIMENSIONS/INCHES		
				H	W	D
	Sliding Door Lock - Right	EVPSLLOCKR	295	2.65	1.2	0.9
	Sliding Door Lock - Left	EVPSLLOCKL	295	2.65	1.2	0.9

EVMPK02 - MINI PANEL KIT

- Evolve's Mini Panel Kits are available to our dealers and their sales staff.
- All Mini Panel Kit orders receive standard freight terms (Free freight applies to orders dock delivered to one commercial business location in the contiguous United States during normal business hours. Residential deliveries will incur additional delivery charges.)
- The Evolve mini panel is an excellent sales tool featuring a cut away of a module and samples of various hardware and electrical components and consists of the following:
 - 1 EVFP3024 30 x 24 Premium with cut-away
 - 1 EVPCP232 Two-way corner post
 - 1 EVPER30 End of run trim kit
 - 1 EVDHPT24 High Profile Top Cap
 - 1 EVDCPHP2 Two-way High Profile Top Cap
 - 1 EVDPE4 Post Extension Lay in
 - 1 EVE8PD24 Power distribution housing
 - 1 EVE8CP16 Jumper Cable
 - 1 EVE8RDA/B Duplex Receptacle
 - 1 Pizza cutter spline tool
 - 1 Replacement fabric
 - 1 Panel Bag with Evolve Logo
 - 1 Parts Bag with Evolve Logo

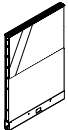
	DESCRIPTION	PRODUCT CODE	LIST PRICE	DIMENSIONS/INCHES		
				H	W	D
	Mini Panel Kit	EVMPK02	2752	30	24	2 7/8

EVPRGLAXXY - ACOUSTIC GRID 5FT WIDE

- PET acoustic grid installed on top of panels
- Acoustic grid kit includes PET pieces, aluminum channel, hardware
- Panels configuration in back 30-30 , aluminum channel runs depth wise
- PET slats run from side to side
- PET pieces available in standard PET colors
- Separate PET colors available for outer skirt and inner structure
- Top trim with channel to be ordered separately
- Shipped KD , to be assembled on job site
- Additional sizes available up to 10' x 12'

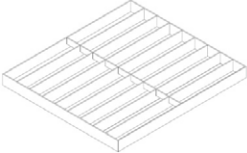
DESCRIPTION	PRODUCT CODE	LIST PRICE	DIMENSIONS/INCHES		
			H	W	D
	EVPRGLA4860D	2552	5.5	60	48
	EVPRGLA6060D	3024	5.5	60	60
	EVPRGLA7260D	3496	5.5	60	72
	EVPRGLA8460D	3968	5.5	60	84
	EVPRGLA9060D	4204	5.5	60	90
	EVPRGLA9660D	4475	5.5	60	96

EVPRGLAXXY - ACOUSTIC GRID 6FT WIDE

- PET acoustic grid installed on top of panels
- Acoustic grid kit includes PET pieces, aluminum channel, hardware
- Panels configuration in back 24-24-24 , aluminum channel runs depth wise
- PET slats run from side to side
- PET pieces available in standard PET colors
- Separate PET colors available for outer skirt and inner structure
- Top trim with channel to be ordered separately
- Shipped KD , to be assembled on job site
- Additional sizes available up to 10' x 12'

DESCRIPTION	PRODUCT CODE	LIST PRICE	DIMENSIONS/INCHES		
			H	W	D
	EVPRGLA4872D	3068	5.5	72	48
	EVPRGLA6072D	3641	5.5	72	60
	EVPRGLA7272D	4212	5.5	72	72
	EVPRGLA8472D	4783	5.5	72	84
	EVPRGLA9072D	5067	5.5	72	90
	EVPRGLA9672D	5388	5.5	72	96

EVPRGLAXXY - ACOUSTIC GRID 7FT WIDE

- PET acoustic grid installed on top of panels
- Acoustic grid kit includes PET pieces, aluminum channel, hardware
- Panels configuration in back 24-36-24 , aluminum channel runs depth wise
- PET slats run from side to side
- PET pieces available in standard PET colors
- Separate PET colors available for outer skirt and inner structure
- Top trim with channel to be ordered separately
- Shipped KD , to be assembled on job site
- Additional sizes available up to 10' x 12'

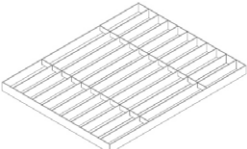
DESCRIPTION	PRODUCT CODE	LIST PRICE	DIMENSIONS/INCHES		
			H	W	D
	EVPRGLA4884D	3430	5.5	84	48
	EVPRGLA6084D	4061	5.5	84	60
	EVPRGLA7284D	4692	5.5	84	72
	EVPRGLA8484D	5323	5.5	84	84
	EVPRGLA9084D	5639	5.5	84	90
	EVPRGLA9684D	5989	5.5	84	96



EVPRGLAXXY - ACOUSTIC GRID 7-1/2 FT WIDE

- PET acoustic grid installed on top of panels
- Acoustic grid kit includes PET pieces, aluminum channel, hardware
- Panels configuration in back 30-30-30 , aluminum channel runs depth wise
- PET slats run from side to side
- PET pieces available in standard PET colors
- Separate PET colors available for outer skirt and inner structure
- Top trim with channel to be ordered separately
- Shipped KD, to be assembled on job site
- Additional sizes available up to 10' x 12'

DESCRIPTION	PRODUCT CODE	LIST PRICE	DIMENSIONS/INCHES		
			H	W	D
	EVPRGLA4890D	3562	5.5	90	48
	EVPRGLA6090D	4222	5.5	90	60
	EVPRGLA7290D	4883	5.5	90	72
	EVPRGLA8490D	5544	5.5	90	84
	EVPRGLA9090D	5876	5.5	90	90
	EVPRGLA9690D	6241	5.5	90	96

EVPRGLAXXY - ACOUSTIC GRID 8FT WIDE

- PET acoustic grid installed on top of panels
- Acoustic grid kit includes PET pieces, aluminum channel, hardware
- Panels configuration in back 30-36-30 , aluminum channel runs depth wise
- PET slats run from side to side
- PET pieces available in standard PET colors
- Separate PET colors available for outer skirt and inner structure
- Top trim with channel to be ordered separately
- Shipped KD, to be assembled on job site
- Additional sizes available up to 10' x 12'

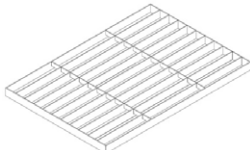
DESCRIPTION	PRODUCT CODE	LIST PRICE	DIMENSIONS/INCHES		
			H	W	D
	EVPRGLA4896D	3826	5.5	96	48
	EVPRGLA6096D	4517	5.5	96	60
	EVPRGLA7296D	5207	5.5	96	72
	EVPRGLA8496D	5899	5.5	96	84
	EVPRGLA9096D	6246	5.5	96	90
	EVPRGLA9696D	6625	5.5	96	96

EVPRGLAXXY - ACOUSTIC GRID 12FT WIDE

- PET acoustic grid installed on top of panels
- Acoustic grid kit includes PET pieces, aluminum channel, hardware
- Panels configuration in back 24-30--36-30-24 , aluminum channel runs depth wise
- PET slats run from side to side
- PET pieces available in standard PET colors
- Top trim with channel to be ordered separately
- Beam kit above opening for acoustic grid to be ordered separately
- Shipped KD, to be assembled on job site

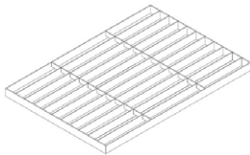
DESCRIPTION	PRODUCT CODE	LIST PRICE	DIMENSIONS/INCHES		
			H	W	D
	EVPRGLA120144D	8805	5.5	144	120

EVPTTCA - ALUMINUM TOP TRIM WITH CHANNEL

- Top trim with channel
- Available in standard paint colors
- Note: Trim can span inline connector, but not a Post

DESCRIPTION	PRODUCT CODE	LIST PRICE	DIMENSIONS/INCHES		
			H	W	D
	EVPTTCA18	18	18	2.875	
	EVPTTCA24	26	24	2.875	
	EVPTTCA30	33	30	2.875	
	EVPTTCA36	36	36	2.875	
	EVPTTCA42	43	42	2.875	
	EVPTTCA48	53	48	2.875	
	EVPTTCA54	62	54	2.875	
	EVPTTCA60	69	60	2.875	
	EVPTTCA66	75	66	2.875	
	EVPTTCA72	84	72	2.875	
	EVPTTCA78	91	78	2.875	
	EVPTTCA84	101	84	2.875	
	EVPTTCA90	107	90	2.875	
	EVPTTCA96	116	96	2.875	



When ordering Panel Extension Modules, Inline Panel Extension Connectors (EVPIEC) must be ordered separately. Please see EVPIEC for details.

Inline Panel Extension Connectors connect two panel extension modules of equal height in a straight run.

Extension connectors do **not** provide support for hang-on storage components above 66" H.

When specifying stacking panels up to 66" H and using a single full height connector additional single clamps (EVCLVAR) are recommended. Order 2 clamps per extension module.

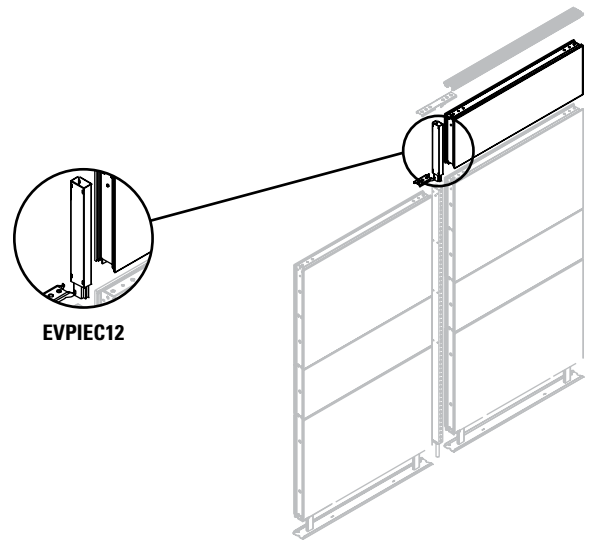
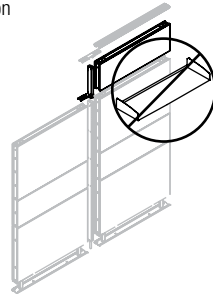

EVPIEC12

EXTENSION MODULES BY TYPE

Fabric Panel Extension Module

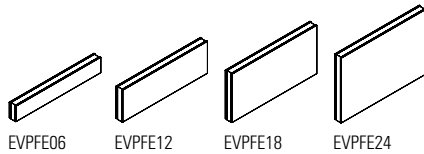

Fabric Panel Extension Module - Premium

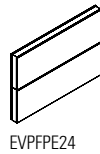

Tempered Glass Panel Extension Module

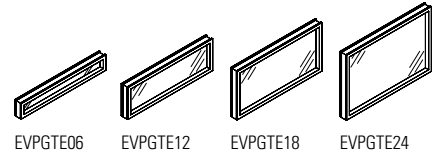

Tempered Glass Panel Extension Module - Premium

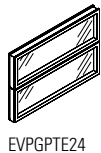

Write Board Extension Module - Single Sided

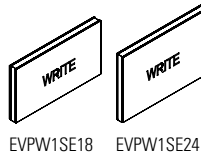

Write Board Extension Module - Double Sided

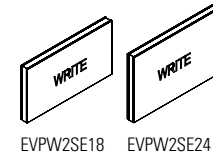

Laminate Extension Module - Single Sided

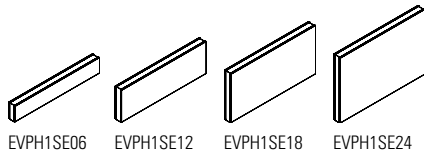

Laminate Extension Module - Double Sided

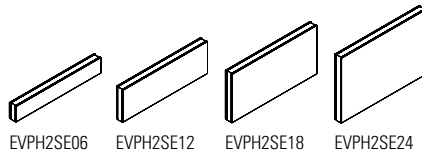

Air Flow Extension Module

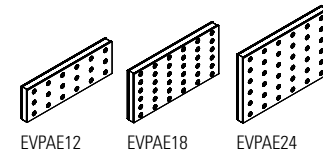

Open Panel Extension Module

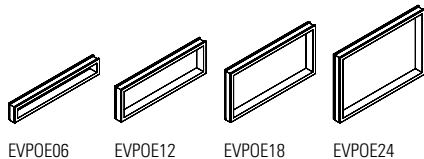

Panel Mount Privacy Glass

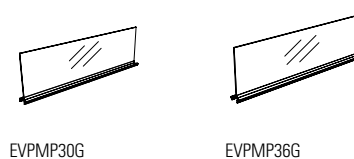

Panel Mount PET Felt Divider

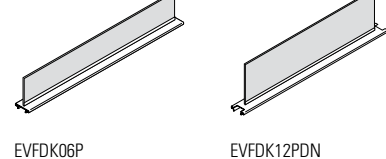

EVPFE - FABRIC PANEL EXTENSION MODULE

- Attaches on top of a panel.
- Modules can be stacked to add privacy or divide space.
- Panel Extension Modules are not load bearing if installed higher than 66" High.
- Each side of the fabric module may have a different fabric within the same grade at no charge.
- If different grades of fabric are used on one module, the entire module must be priced at highest grade.
- When ordering Panel Extension Modules, additional connectors are required.
- *Top Trims are not included with Extension Modules.

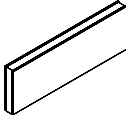
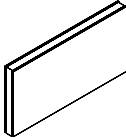
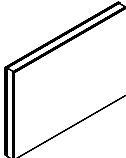
	DESCRIPTION	PRODUCT CODE	LIST PRICE		DIMENSIONS/INCHES		
			Gr1	Gr2	H	W	D
	Fabric Panel Extension Module - 6" High	EVPFE0618	185	193	6	18	2 7/8
		EVPFE0624	187	201	6	24	2 7/8
		EVPFE0630	205	221	6	30	2 7/8
		EVPFE0636	228	246	6	36	2 7/8
		EVPFE0642	258	273	6	42	2 7/8
		EVPFE0648	277	298	6	48	2 7/8
		EVPFE0654	299	320	6	54	2 7/8
		EVPFE0660	321	348	6	60	2 7/8
	Fabric Panel Extension Module - 12" High	EVPFE1218	185	193	12	18	2 7/8
		EVPFE1224	187	201	12	24	2 7/8
		EVPFE1230	205	221	12	30	2 7/8
		EVPFE1236	228	246	12	36	2 7/8
		EVPFE1242	258	273	12	42	2 7/8
		EVPFE1248	277	298	12	48	2 7/8
		EVPFE1254	299	320	12	54	2 7/8
		EVPFE1260	321	348	12	60	2 7/8
	Fabric Panel Extension Module - 18" High	EVPFE1818	223	239	18	18	2 7/8
		EVPFE1824	231	252	18	24	2 7/8
		EVPFE1830	251	277	18	30	2 7/8
		EVPFE1836	291	318	18	36	2 7/8
		EVPFE1842	319	354	18	42	2 7/8
		EVPFE1848	349	385	18	48	2 7/8
		EVPFE1854	378	419	18	54	2 7/8
		EVPFE1860	411	455	18	60	2 7/8
	Fabric Panel Extension Module - 24" High	EVPFE2418	223	239	24	18	2 7/8
		EVPFE2424	231	252	24	24	2 7/8
		EVPFE2430	251	277	24	30	2 7/8
		EVPFE2436	291	318	24	36	2 7/8
		EVPFE2442	319	354	24	42	2 7/8
		EVPFE2448	349	385	24	48	2 7/8
		EVPFE2454	378	419	24	54	2 7/8
		EVPFE2460	411	455	24	60	2 7/8

EVPFPE - FABRIC PANEL EXTENSION MODULE - PREMIUM

- Attaches on top of a panel.
- Modules can be stacked to add privacy or to divide space.
- Panel Extension Modules are not load bearing above 66" High.
- Each side of each module may have a different fabric within the same grade at no charge.
- If different grades of fabric are used on the Panel Extension Module, the module must be priced at highest grade.
- When ordering Panel Extension Modules, additional connectors are required.
- *Top Trims are not included with Extension Modules.

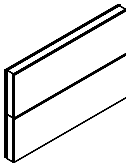
	DESCRIPTION	PRODUCT CODE	LIST PRICE		DIMENSIONS/INCHES		
			Gr1	Gr2	H	W	D
	Fabric Panel Extension Module - Premium - 24" High	EVPFPE2418	301	318	24	18	2 7/8
		EVPFPE2424	321	345	24	24	2 7/8
		EVPFPE2430	360	386	24	30	2 7/8
		EVPFPE2436	405	432	24	36	2 7/8
		EVPFPE2442	455	490	24	42	2 7/8
		EVPFPE2448	488	526	24	48	2 7/8
		EVPFPE2454	539	580	24	54	2 7/8
		EVPFPE2460	588	634	24	60	2 7/8



EVPGTE - TEMPERED GLASS PANEL EXTENSION MODULE

- Attaches on top of panel.
- Modules can be stacked to add privacy or to divide space.
- Panel Extension Modules are not load bearing above 66" H.
- Standard in clear (CLR) glass.
- Frosted Glass (FRST) 40% upcharge. Contact EVOLVE Customer Support for details.
- When ordering Panel Extension Modules, additional connectors are required.
- *Top Trims are not included with Extension Modules.

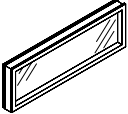
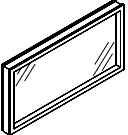
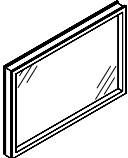
	DESCRIPTION	PRODUCT CODE	LIST PRICE	DIMENSIONS/INCHES		
				H	W	D
	Tempered Glass Panel Extension Module - 6" High	EVPGTE0618	355	6	18	2 7/8
		EVPGTE0624	383	6	24	2 7/8
		EVPGTE0630	459	6	30	2 7/8
		EVPGTE0636	481	6	36	2 7/8
		EVPGTE0642	588	6	42	2 7/8
		EVPGTE0648	656	6	48	2 7/8
		EVPGTE0654	717	6	54	2 7/8
EVPGTE0660	773	6	60	2 7/8		
	Tempered Glass Panel Extension Module - 12" High	EVPGTE1218	355	12	18	2 7/8
		EVPGTE1224	383	12	24	2 7/8
		EVPGTE1230	459	12	30	2 7/8
		EVPGTE1236	481	12	36	2 7/8
		EVPGTE1242	588	12	42	2 7/8
		EVPGTE1248	656	12	48	2 7/8
		EVPGTE1254	717	12	54	2 7/8
EVPGTE1260	773	12	60	2 7/8		
	Tempered Glass Panel Extension Module - 18" High	EVPGTE1818	533	18	18	2 7/8
		EVPGTE1824	548	18	24	2 7/8
		EVPGTE1830	587	18	30	2 7/8
		EVPGTE1836	641	18	36	2 7/8
		EVPGTE1842	726	18	42	2 7/8
		EVPGTE1848	813	18	48	2 7/8
		EVPGTE1854	882	18	54	2 7/8
EVPGTE1860	946	18	60	2 7/8		
	Tempered Glass Panel Extension Module - 24" High	EVPGTE2418	533	24	18	2 7/8
		EVPGTE2424	548	24	24	2 7/8
		EVPGTE2430	587	24	30	2 7/8
		EVPGTE2436	641	24	36	2 7/8
		EVPGTE2442	726	24	42	2 7/8
		EVPGTE2448	813	24	48	2 7/8
		EVPGTE2454	882	24	54	2 7/8
EVPGTE2460	946	24	60	2 7/8		

EVPGPTE - TEMPERED GLASS PREMIUM PANEL EXTENSION MODULE

- Attaches to top of a panel.
- Modules can be stacked to add privacy or to divide space.
- Panel Extension Modules are not load bearing above 66" H.
- Standard in clear (CLR) glass.
- Frosted Glass (FRST) 40% upcharge. Contact EVOLVE Customer Support for details.
- When ordering Panel Extension Modules, additional connectors are required.
- *Top Trims are not included with Extension Modules.

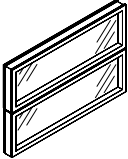
	DESCRIPTION	PRODUCT CODE	LIST PRICE	DIMENSIONS/INCHES		
				H	W	D
	Tempered Glass Premium Panel Extension Module - 24" High	EVPGPTE2418	525	24	18	2 7/8
		EVPGPTE2424	582	24	24	2 7/8
		EVPGPTE2430	665	24	30	2 7/8
		EVPGPTE2436	757	24	36	2 7/8
		EVPGPTE2442	839	24	42	2 7/8
		EVPGPTE2448	941	24	48	2 7/8
		EVPGPTE2454	1026	24	54	2 7/8
EVPGPTE2460	1111	224	60	2 7/8		

EVPSG - PASS THRU SLIDING GLASS EXTENSION MODULE

- Pass thru with sliding glass door module.
- Attaches on top of a panel.
- Module can be stacked to add privacy or divide space.
- Panel extension module is not load bearing if installed higher than 66" High.
- When ordering panel extension modules , additional connectors are required.
- *Top Trims are not included with Extension Modules.

	DESCRIPTION	PRODUCT CODE	LIST PRICE		DIMENSIONS/INCHES		
			CLR	FRS	H	W	D
	Reception Panel Extension Module - 6" High	EVPSGE0636	384	464	6	36	2 7/8
		EVPSGE0642	411	497	6	42	2 7/8
		EVPSGE0648	500	601	6	48	2 7/8

EVPSG - PASS THRU SLIDING GLASS EXTENSION MODULE

- Pass thru with sliding glass door module.
- Attaches on top of a panel.
- Module can be stacked to add privacy or divide space.
- Panel extension module is not load bearing if installed higher than 66" High.
- When ordering panel extension modules , additional connectors are required.
- *Top Trims are not included with Extension Modules.

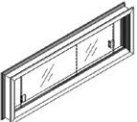
	DESCRIPTION	PRODUCT CODE	LIST PRICE		DIMENSIONS/INCHES		
			CLR	FRS	H	W	D
	Reception Panel Extension Module - 12" High	EVPSGE1236	465	560	12	36	2 7/8
		EVPSGE1242	492	593	12	42	2 7/8
		EVPSGE1248	515	622	12	48	2 7/8

EVPSGX - TALK THRU GLASS EXTENSION MODULE

- Talk thru glass module.
- Attaches on top of a panel.
- Module can be stacked to add privacy or divide space.
- Panel extension module is not load bearing if installed higher than 66" High.
- When ordering panel extension modules , additional connectors are required.
- *Top Trims are not included with Extension Modules.

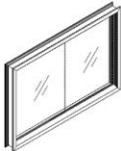
	DESCRIPTION	PRODUCT CODE	LIST PRICE		DIMENSIONS/INCHES		
			CLR	FRS	H	W	D
	Reception Panel Extension Module - 24" High	EVPSGXE2436	598	719	24	36	2 7/8
		EVPSGXE2442	658	789.6	24	42	2 7/8
		EVPSGXE2448	717	864	24	48	2 7/8

EVPSGX - TALK THRU GLASS EXTENSION MODULE

- Talk thru glass module.
- Attaches on top of a panel.
- Module can be stacked to add privacy or divide space.
- Panel extension module is not load bearing if installed higher than 66" High.
- When ordering panel extension modules , additional connectors are required.
- *Top Trims are not included with Extension Modules.

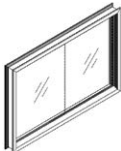
	DESCRIPTION	PRODUCT CODE	LIST PRICE		DIMENSIONS/INCHES		
			CLR	FRS	H	W	D
	Reception Panel Extension Module - 30" High	EVPSGXE3036	652	781	30	36	2 7/8
		EVPSGXE3042	733	882	30	42	2 7/8
		EVPSGXE3048	794	955	30	48	2 7/8



EVPW1SE - WRITE BOARD EXTENSION MODULE - SINGLE SIDED

- Attaches on top of a panel.
- Provides writing surface on a Single Side.
- Modules can be stacked to add privacy or to divide space.
- Panel Extension Modules are not load bearing above 66" H.
- When ordering Panel Extension Modules, additional connectors are required.
- High pressure only
- Use erasable Write Board markers only.
- *Top Trims are not included with Extension Modules.

DESCRIPTION	PRODUCT CODE	LIST PRICE		DIMENSIONS/INCHES		
		Gr1	Gr2	H	W	D
 Write Board Extension Module - Single Sided 6"High	EVPW1SE0618	251	259	6	36	7/8
	EVPW1SE0624	292	301	6	36	2 7/8
	EVPW1SE0636	371	381	6	36	2 7/8
	EVPW1SE0642	420	425	6	42	2 7/8
	EVPW1SE0648	457	469	6	48	2 7/8
	EVPW1SE0654	515	527	6	54	2 7/8
	EVPW1SE0660	542	554	6	60	2 7/8
Write Board Extension Module - Single Sided 12"High	EVPW1SE1218	251	259	12	36	2 7/8
	EVPW1SE1224	292	301	12	36	2 7/8
	EVPW1SE1236	371	381	12	36	2 7/8
	EVPW1SE1242	420	425	12	42	2 7/8
	EVPW1SE1248	457	469	12	48	2 7/8
	EVPW1SE1254	515	527	12	54	2 7/8
	EVPW1SE1260	542	554	12	60	2 7/8
Write Board Extension Module - Single Sided 18"High	EVPW1SE1818	269	279	18	18	2 7/8
	EVPW1SE1824	308	319	18	24	2 7/8
	EVPW1SE1830	347	356	18	30	2 7/8
	EVPW1SE1836	404	418	18	36	2 7/8
	EVPW1SE1842	453	469	18	42	2 7/8
	EVPW1SE1848	497	514	18	48	2 7/8
	EVPW1SE1854	541	558	18	54	2 7/8
EVPW1SE1860	582	602	18	60	2 7/8	
Write Board Extension Module - Single Sided 24"High	EVPW1SE2418	269	279	24	18	2 7/8
	EVPW1SE2424	308	321	24	24	2 7/8
	EVPW1SE2430	347	360	24	30	2 7/8
	EVPW1SE2436	404	419	24	36	2 7/8
	EVPW1SE2442	453	471	24	42	2 7/8
	EVPW1SE2448	497	516	24	48	2 7/8
	EVPW1SE2454	541	558	24	54	2 7/8
EVPW1SE2460	582	603	24	60	2 7/8	

EVPW2SE - WRITE BOARD EXTENSION MODULE - DOUBLE SIDED

- Attaches on top of a panel.
- Provides writing surface on two sides.
- Modules can be stacked to add privacy or to divide space.
- Panel Extension Modules are not load bearing above 66" H.
- When ordering Panel Extension Modules, additional connectors are required.
- High pressure only
- Use erasable Write Board markers only.
- *Top Trims are not included with Extension Modules.

	DESCRIPTION	PRODUCT CODE	LIST PRICE	DIMENSIONS/INCHES			
				H	W	D	
	Write Board Extension Module - Double Sided - 6" High	EVPW2SE0618	270	6	18	2 7/8	
		EVPW2SE0624	319	6	24	2 7/8	
		EVPW2SE0630	368	6	30	2 7/8	
		EVPW2SE0636	422	6	36	2 7/8	
		EVPW2SE0642	479	6	42	2 7/8	
		EVPW2SE0648	534	6	48	2 7/8	
		EVPW2SE0654	616	6	54	2 7/8	
		EVPW2SE0660	632	6	60	2 7/8	
		Write Board Extension Module - Double Sided - 12" High	EVPW2SE1218	270	12	18	2 7/8
			EVPW2SE1224	319	12	24	2 7/8
EVPW2SE1230	368		12	30	2 7/8		
EVPW2SE1236	422		12	36	2 7/8		
EVPW2SE1242	479		12	42	2 7/8		
EVPW2SE1248	534		12	48	2 7/8		
EVPW2SE1254	616		12	54	2 7/8		
EVPW2SE1260	632		12	60	2 7/8		
Write Board Extension Module - Double Sided - 18" High	EVPW2SE1818	325	18	18	2 7/8		
	EVPW2SE1824	383	18	24	2 7/8		
	EVPW2SE1830	440	18	30	2 7/8		
	EVPW2SE1836	515	18	36	2 7/8		
	EVPW2SE1842	582	18	42	2 7/8		
	EVPW2SE1848	649	18	48	2 7/8		
	EVPW2SE1854	718	18	54	2 7/8		
	EVPW2SE1860	784	18	60	2 7/8		
Write Board Extension Module - Double Sided - 24" High	EVPW2SE2418	325	24	18	2 7/8		
	EVPW2SE2424	383	24	24	2 7/8		
	EVPW2SE2430	440	24	30	2 7/8		
	EVPW2SE2436	515	24	36	2 7/8		
	EVPW2SE2442	582	24	42	2 7/8		
	EVPW2SE2448	649	24	48	2 7/8		
	EVPW2SE2454	718	24	54	2 7/8		
	EVPW2SE2460	784	24	60	2 7/8		



EVPH1SE - LAMINATE EXTENSION MODULE - SINGLE SIDED

- Attaches on top of a panel.
- Laminate face on the module provides a durable, washable surface on Single Side of the panel.
- Modules can be stacked to add privacy or to divide space.
- Panel Extension Modules are not load bearing above 66" H.
- When ordering Panel Extension Modules, additional connectors are required.
- Available in high pressure only.
- *Top Trims are not included with Extension Modules.

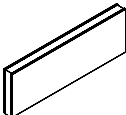
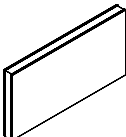
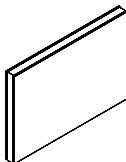
	DESCRIPTION	PRODUCT CODE	LIST PRICE		DIMENSIONS/INCHES		
			Gr1	Gr2	H	W	D
	Laminate Extension Module - Single Sided 6" High	EVPH1SE0618	251	259	6	18	2 7/8
		EVPH1SE0624	292	295	6	24	2 7/8
		EVPH1SE0630	327	329	6	30	2 7/8
		EVPH1SE0636	371	376	6	36	2 7/8
		EVPH1SE0642	420	422	6	42	2 7/8
		EVPH1SE0648	457	470	6	48	2 7/8
		EVPH1SE0654	515	527	6	54	2 7/8
		EVPH1SE0660	542	547	6	60	2 7/8
	Laminate Extension Module - Single Sided 12" High	EVPH1SE1218	251	259	12	18	2 7/8
		EVPH1SE1224	292	302	12	24	2 7/8
		EVPH1SE1230	327	334	12	30	2 7/8
		EVPH1SE1236	371	384	12	36	2 7/8
		EVPH1SE1242	420	429	12	42	2 7/8
		EVPH1SE1248	457	471	12	48	2 7/8
		EVPH1SE1254	515	529	12	54	2 7/8
		EVPH1SE1260	542	556	12	60	2 7/8
	Laminate Extension Module - Single Sided 18" High	EVPH1SE1818	335	344	18	18	2 7/8
		EVPH1SE1824	395	405	18	24	2 7/8
		EVPH1SE1830	455	469	18	30	2 7/8
		EVPH1SE1836	520	534	18	36	2 7/8
		EVPH1SE1842	587	601	18	42	2 7/8
		EVPH1SE1848	644	659	18	48	2 7/8
		EVPH1SE1854	697	717	18	54	2 7/8
		EVPH1SE1860	767	788	18	60	2 7/8
	Laminate Extension Module - Single Sided 24" High	EVPH1SE2418	335	348	24	18	2 7/8
		EVPH1SE2424	395	409	24	24	2 7/8
		EVPH1SE2430	455	471	24	30	2 7/8
		EVPH1SE2436	520	537	24	36	2 7/8
		EVPH1SE2442	587	604	24	42	2 7/8
		EVPH1SE2448	644	662	24	48	2 7/8
		EVPH1SE2454	697	721	24	54	2 7/8
		EVPH1SE2460	767	792	24	60	2 7/8

EVPH2SE - LAMINATE EXTENSION MODULE - DOUBLE SIDED

- Attaches on top of a panel.
- Laminate faces on both sides of the module provide durable, washable surfaces
- Modules can be stacked to add privacy or to divide space.
- Panel Extension Modules are not load bearing above 66" H
- When ordering Panel Extension Modules, additional connectors are required.
- Available in high pressure only.
- *Top Trims are not included with Extension Modules.

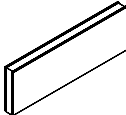
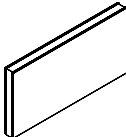
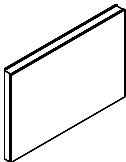
	DESCRIPTION	PRODUCT CODE	LIST PRICE	DIMENSIONS/INCHES		
				H	W	D
	Laminate Extension Module - Double Sided 6" High	EVPH2SE0618	270	6	18	2 7/8
		EVPH2SE0624	319	6	24	2 7/8
		EVPH2SE0630	368	6	30	2 7/8
		EVPH2SE0636	422	6	36	2 7/8
		EVPH2SE0642	479	6	42	2 7/8
		EVPH2SE0648	534	6	48	2 7/8
		EVPH2SE0654	616	6	54	2 7/8
		EVPH2SE0660	646	6	60	2 7/8
	Laminate Extension Module - Double Sided 12" High	EVPH2SE1218	270	12	18	2 7/8
		EVPH2SE1224	319	12	24	2 7/8
		EVPH2SE1230	368	12	30	2 7/8
		EVPH2SE1236	422	12	36	2 7/8
		EVPH2SE1242	479	12	42	2 7/8
		EVPH2SE1248	534	12	48	2 7/8
		EVPH2SE1254	616	12	54	2 7/8
		EVPH2SE1260	632	12	60	2 7/8
	Laminate Extension Module - Double Sided 18" High	EVPH2SE1818	388	18	18	2 7/8
		EVPH2SE1824	469	18	24	2 7/8
		EVPH2SE1830	542	18	30	2 7/8
		EVPH2SE1836	629	18	36	2 7/8
		EVPH2SE1842	710	18	42	2 7/8
		EVPH2SE1848	805	18	48	2 7/8
		EVPH2SE1854	882	18	54	2 7/8
		EVPH2SE1860	950	18	60	2 7/8
	Laminate Extension Module - Double Sided 24" High	EVPH2SE2418	388	24	18	2 7/8
		EVPH2SE2424	469	24	24	2 7/8
		EVPH2SE2430	542	24	30	2 7/8
		EVPH2SE2436	629	24	36	2 7/8
		EVPH2SE2442	710	24	42	2 7/8
		EVPH2SE2448	805	24	48	2 7/8
		EVPH2SE2454	882	24	54	2 7/8
		EVPH2SE2460	950	24	60	2 7/8



EVPAE - AIR FLOW EXTENSION MODULE

- Metal air flow panel extension
- Attaches to top of panel
- Modules can be stacked to add privacy or to divide space.
- Panel Extension Modules are not load bearing above 66" H.
- When ordering Panel Extension Modules, additional connectors are required.
- *Top Trims are not included with Extension Modules.

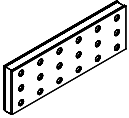
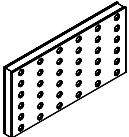
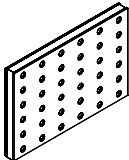
	DESCRIPTION	PRODUCT CODE	LIST PRICE	DIMENSIONS/INCHES		
				H	W	D
	Air Flow Extension Module - 12" High	EVPAE1224	325	12	24	2 7/8
		EVPAE1230	388	12	30	2 7/8
		EVPAE1236	439	12	36	2 7/8
		EVPAE1242	484	12	42	2 7/8
		EVPAE1248	548	12	48	2 7/8
		EVPAE1254	633	18	54	2 7/8
		EVPAE1260	721	12	60	2 7/8
	Air Flow Extension Module - 18" High	EVPAE1824	409	18	24	2 7/8
		EVPAE1830	477	18	30	2 7/8
		EVPAE1836	528	18	36	2 7/8
		EVPAE1842	578	18	42	2 7/8
		EVPAE1848	665	18	48	2 7/8
		EVPAE1854	764	18	54	2 7/8
		EVPAE1860	858	18	60	2 7/8
	Air Flow Extension Module - 24" High	EVPAE2424	409	24	24	2 7/8
		EVPAE2430	477	24	30	2 7/8
		EVPAE2436	528	24	36	2 7/8
		EVPAE2442	578	24	42	2 7/8
		EVPAE2448	665	24	48	2 7/8
		EVPAE2454	757	18	54	2 7/8
		EVPAE2460	858	24	60	2 7/8

EVPOE - OPEN PANEL EXTENSION MODULE

- Attaches to top portion of a panel.
- Modules can be stacked to add privacy or to divide space
- Panel Extension Modules are not load bearing above 66" H.
- When ordering Panel Extension Modules, additional connectors are required.
- *Top Trims are not included with Extension Modules.

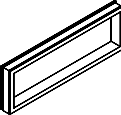
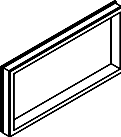
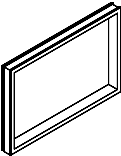
	DESCRIPTION	PRODUCT CODE	LIST PRICE	DIMENSIONS/INCHES		
				H	W	D
	Open Panel Extension Module - 6" High	EVPOE0618	289	6	18	2 7/8
		EVPOE0624	295	6	24	2 7/8
		EVPOE0630	360	6	30	2 7/8
		EVPOE0636	376	6	36	2 7/8
		EVPOE0642	456	6	42	2 7/8
		EVPOE0648	512	6	48	2 7/8
		EVPOE0654	558	6	54	2 7/8
		EVPOE0660	602	6	60	2 7/8
	Open Panel Extension Module - 12" High	EVPOE1218	291	12	18	2 7/8
		EVPOE1224	297	12	24	2 7/8
		EVPOE1230	360	12	30	2 7/8
		EVPOE1236	376	12	36	2 7/8
		EVPOE1242	456	12	42	2 7/8
		EVPOE1248	513	12	48	2 7/8
		EVPOE1254	558	12	54	2 7/8
		EVPOE1260	604	12	60	2 7/8
	Open Panel Extension Module - 18" High	EVPOE1818	424	18	18	2 7/8
		EVPOE1824	431	18	24	2 7/8
		EVPOE1830	456	18	30	2 7/8
		EVPOE1836	499	18	36	2 7/8
		EVPOE1842	561	18	42	2 7/8
		EVPOE1848	633	18	48	2 7/8
		EVPOE1854	686	18	54	2 7/8
		EVPOE1860	739	18	60	2 7/8
	Open Panel Extension Module - 24" High	EVPOE2418	431	24	18	2 7/8
		EVPOE2424	424	24	24	2 7/8
		EVPOE2430	456	24	30	2 7/8
		EVPOE2436	499	24	36	2 7/8
		EVPOE2442	561	24	42	2 7/8
		EVPOE2448	633	24	48	2 7/8
		EVPOE2454	686	24	54	2 7/8
		EVPOE2460	739	24	60	2 7/8



EVPIECBS - BRIDGE PANEL INLINE EXTENSION CONNECTOR

- Connects bridge panel to inline extension connector.
- Includes one bridge extension connector and connecting hardware.

DESCRIPTION	PRODUCT CODE	LIST PRICE	DIMENSIONS/INCHES		
			H	W	D
 Bridge Panel Inline Extension Connector	EVPIECBS06	49	6	3	3
	EVPIECBS12	49	12	3	3
	EVPIECBS18	58	18	3	3
	EVPIECBS24	58	24	3	3

EVPEERBSA - BRIDGE PANEL END OF RUN EXTENSION CONNECTOR - ALUMINUM TRIM

- Connects at end of run of bridge panel and can attach panel to fixed wall.
- Adds 1" to width of panel run.
- Provides slotted support for worksurfaces and hang on components up to 66"H.
- Includes one slotted bridge extension connector and connecting hardware and trim kit.

DESCRIPTION	PRODUCT CODE	LIST PRICE	DIMENSIONS/INCHES		
			H	W	D
 Bridge Panel End of Run Extension Connector Aluminum Trim	EVPEERBSA06	53	6	3	3
	EVPEERBSA12	53	12	3	3
	EVPEERBSA18	64	18	3	3
	EVPEERBSA24	64	24	3	3

EVPICBS - BRIDGE PANEL INLINE CONNECTOR WITHOUT ALUMINUM INSERT

- Connects two bridge panels to inline connector.
- Inline connector in middle between two bridge panels, above opening, using double clamp at bottom.
- Includes one bridge extension connector without aluminum insert, includes connecting hardware.

DESCRIPTION	PRODUCT CODE	LIST PRICE	DIMENSIONS/INCHES		
			H	W	D
 Bridge Panel Inline Connector without Aluminum Insert	EVPICBS06	49	6	3	3
	EVPICBS12	49	12	3	3
	EVPICBS18	58	18	3	3
	EVPICBS24	58	24	3	3

EVPCEPB1 - BRIDGE PANEL CORNER EXTENSION POST 1 WAY

- Connects at end of a run of extension modules.
- Post and connecting hardware add 3.25" to power beam run.
- Includes one extension post, one slotted extension connectors for bridge panel, connecting hardware and trim kit.

	DESCRIPTION	PRODUCT CODE	LIST PRICE	DIMENSIONS/INCHES		
				H	W	D
	Bridge Panel Inline Extension Connector	EVPCEPBSA106	90	6	3	3
		EVPCEPBSA112	90	12	3	3
		EVPCEPBSA118	114	18	3	3
		EVPCEPBSA124	114	24	3	3

EVPCEPB2 - BRIDGE PANEL CORNER EXTENSION POST 2 WAY

- Connects two bridge panels in 90 degree configuration.
- Post and connecting hardware add 3.25" to power beam run.
- Includes one extension post, two one slotted extension connectors for bridge panel, connecting hardware and trim kit.

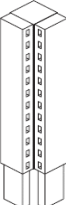
	DESCRIPTION	PRODUCT CODE	LIST PRICE	DIMENSIONS/INCHES		
				H	W	D
	Bridge Panel Corner Extension Post 2 way	EVPCEPBSA206	92	6	3	3
		EVPCEPBSA212	92	12	3	3
		EVPCEPBSA218	145	18	3	3
		EVPCEPBSA224	145	24	3	3

EVPCEPB3 - BRIDGE PANEL CORNER EXTENSION POST 3 WAY

- Connects three bridge panels in T degree configuration.
- Post and connecting hardware add 3.25" to power beam run.
- Includes one extension post, three one slotted extension connectors for bridge panel, connecting hardware and trim kit.

	DESCRIPTION	PRODUCT CODE	LIST PRICE	DIMENSIONS/INCHES		
				H	W	D
	Bridge Panel Corner Extension Post 3 way	EVPCEPBSA306	110	6	3	3
		EVPCEPBSA312	110	12	3	3
		EVPCEPBSA318	170	18	3	3
		EVPCEPBSA324	170	24	3	3



EVPCEPB4 - BRIDGE PANEL CORNER EXTENSION POST 4 WAY

- Connects four bridge panels in X degree configuration.
- Post and connecting hardware add 3.25" to power beam run.
- Includes one extension post, four one slotted extension connectors for bridge panel, connecting hardware and trim kit.

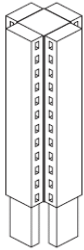

DESCRIPTION	PRODUCT CODE	LIST PRICE	DIMENSIONS/INCHES		
			H	W	D
Bridge Panel Corner Extension Post 4 way	EVPCEPBS406	127	6	3	3
	EVPCEPBS412	127	12	3	3
	EVPCEPBS418	187	18	3	3
	EVPCEPBS424	187	24	3	3

EVPCEIPBSA2 - BRIDGE PANEL INLINE TWO WAY POST EXTENSION

- Connects two bridge panels in straight run.
- Post and connecting hardware add 3.25" to power beam run.
- Includes one extension post, two slotted extension connectors for bridge panel, connecting hardware and trim kit.



DESCRIPTION	PRODUCT CODE	LIST PRICE	DIMENSIONS/INCHES		
			H	W	D
Bridge Panel Inline Extension Post 2 way	EVPCEIPBSA206	97	6	3	3
	EVPCEIPBSA212	97	12	3	3
	EVPCEIPBSA218	158	18	3	3
	EVPCEIPBSA224	158	24	3	3

EVPFEB - FABRIC PANEL BRIDGE MODULE

- Bridge modules connects two panels above opening.
- Requires bridge extension connectors, connects with clamps on top and at bottom.
- Each side of fabric module may have different fabric within the same grade at no charge.
- If different grades of fabric are used, the entire module must be price at highest grade.
- When ordering bridge modules , additional bridge connectors are required.
- Aluminum trim for bottom to be ordered separately.

DESCRIPTION	PRODUCT CODE	LIST PRICE		DIMENSIONS/INCHES		
		Gr1	Gr2	H	W	D
 <p>Fabric Panel Bridge Module - 6" High</p>	EVPFEB0618	185	193	6	18	3
	EVPFEB0624	187	201	6	24	3
	EVPFEB0630	205	221	6	30	3
	EVPFEB0636	228	246	6	36	3
	EVPFEB0642	258	273	6	42	3
	EVPFEB0648	277	298	6	48	3
	EVPFEB0654	299	320	6	54	3
	EVPFEB0660	321	348	6	60	3
<p>Fabric Panel Bridge Module - 12" High</p>	EVPFEB1218	185	193	12	18	3
	EVPFEB1224	187	201	12	24	3
	EVPFEB1230	205	221	12	30	3
	EVPFEB1236	228	246	12	36	3
	EVPFEB1242	258	273	12	42	3
	EVPFEB1248	277	298	12	48	3
	EVPFEB1254	299	320	12	54	3
	EVPFEB1260	321	348	12	60	3
<p>Fabric Panel Bridge Module - 18" High</p>	EVPFEB1818	223	239	18	18	3
	EVPFEB1824	231	252	18	24	3
	EVPFEB1830	251	277	18	30	3
	EVPFEB1836	291	318	18	36	3
	EVPFEB1842	319	354	18	42	3
	EVPFEB1848	349	385	18	48	3
	EVPFEB1854	378	419	18	54	3
	EVPFEB1860	411	455	18	60	3
<p>Fabric Panel Bridge Module - 24" High</p>	EVPFEB2418	223	239	24	18	3
	EVPFEB2424	231	252	24	24	3
	EVPFEB2430	251	277	24	30	3
	EVPFEB2436	291	318	24	36	3
	EVPFEB2442	319	354	24	42	3
	EVPFEB2448	349	385	24	48	3
	EVPFEB2454	378	419	24	54	3
	EVPFEB2460	411	455	24	60	3

EVPFPEB - FABRIC PANEL BRIDGE MODULE - PREMIUM

- Bridge modules connects two panels above opening.
- Requires bridge extension connectors, connects with clamps on top and at bottom.
- Each side of fabric module may have different fabric within the same grade at no charge.
- If different grades of fabric are used, the entire module must be price at highest grade.
- When ordering bridge modules , additional bridge connectors are required.
- Aluminum trim for bottom to be ordered separately.

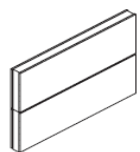
DESCRIPTION	PRODUCT CODE	LIST PRICE		DIMENSIONS/INCHES		
		Gr1	Gr2	H	W	D
 <p>Fabric Panel Bridge Module - Premium</p>	EVPFPEB2418	301	318	24	18	3
	EVPFPEB2424	321	345	24	24	3
	EVPFPEB2430	360	386	24	30	3
	EVPFPEB2436	405	432	24	36	3
	EVPFPEB2442	455	490	24	42	3
	EVPFPEB2448	488	526	24	48	3
	EVPFPEB2454	539	580	24	54	3
	EVPFPEB2460	588	634	24	60	3



EVPGTB - TEMPERED GLASS BRIDGE MODULE

- Bridge modules connects two panels above opening.
- Requires bridge extension connectors, connects with clamps on top and at bottom.
- Standard in clear (CLR) glass.
- Frosted glass (FRST) 40% upcharge. Contact Evolve Customer support for details.
- When ordering bridge modules, additional bridge connectors are required.
- Aluminum trim for bottom to be ordered separately.

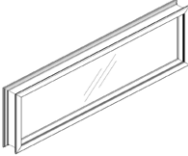
	DESCRIPTION	PRODUCT CODE	LIST PRICE	DIMENSIONS/INCHES			
				H	W	D	
	Tempered Glass Bridge Module - 6" High	EVPGTB0618	355	6	18	3	
		EVPGTB0624	383	6	24	3	
		EVPGTB0630	459	6	30	3	
		EVPGTB0636	481	6	36	3	
		EVPGTB0642	588	6	42	3	
		EVPGTB0648	656	6	48	3	
		EVPGTB0654	717	6	54	3	
		EVPGTB0660	773	6	60	3	
		Tempered Glass Bridge Module - 12" High	EVPGTB1218	355	12	18	3
			EVPGTB1224	383	12	24	3
EVPGTB1230	459		12	30	3		
EVPGTB1236	481		12	36	3		
EVPGTB1242	588		12	42	3		
EVPGTB1248	656		12	48	3		
EVPGTB1254	717		12	54	3		
EVPGTB1260	773		12	60	3		
Tempered Glass Bridge Module - 18" High	EVPGTB1818	533	18	18	3		
	EVPGTB1824	548	18	24	3		
	EVPGTB1830	587	18	30	3		
	EVPGTB1836	641	18	36	3		
	EVPGTB1842	726	18	42	3		
	EVPGTB1848	813	18	48	3		
	EVPGTB1854	882	18	54	3		
	EVPGTB1860	946	18	60	3		
Tempered Glass Bridge Module - 24" High	EVPGTB2418	533	24	18	3		
	EVPGTB2424	548	24	24	3		
	EVPGTB2430	587	24	30	3		
	EVPGTB2436	641	24	36	3		
	EVPGTB2442	726	24	42	3		
	EVPGTB2448	813	24	48	3		
	EVPGTB2454	882	24	54	3		
	EVPGTB2460	946	24	60	3		

EVPGTEB - TEMPERED GLASS BRIDGE MODULE - PREMIUM

- Bridge modules connects two panels above opening.
- Requires bridge extension connectors, connects with clamps at bottom.
- Standard in clear (CLR) glass.
- Frosted glass (FRST) 40% upcharge. Contact Evolve Customer support for details.
- When ordering bridge modules, additional bridge connectors are required.
- Aluminum trim for bottom to be ordered separately.

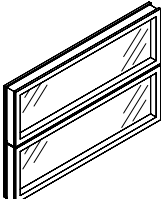
	DESCRIPTION	PRODUCT CODE	LIST PRICE	DIMENSIONS/INCHES		
				H	W	D
	Tempered Glass Bridge Module - Premium	EVPGTEB2418	525	24	18	3
		EVPGTEB2424	582	24	24	3
		EVPGTEB2430	665	24	30	3
		EVPGTEB2436	757	24	36	3
		EVPGTEB2442	839	24	42	3
		EVPGTEB2448	941	24	48	3
		EVPGTEB2454	1026	24	54	3
		EVPGTEB2460	1111	24	60	3

EVPW1SEB - WRITE BOARD BRIDGE MODULE - SINGLE SIDED

- Bridge modules connects two panels above opening.
- Requires bridge extension connectors, connects with clamps at bottom.
- Provides writing surface on Single side.
- Panel extension module is not load bearing if installed higher than 66" High.
- Use erasable Write Board markers only.
- When ordering bridge modules, additional bridge connectors are required.
- Aluminum trim for bottom to be ordered separately.

DESCRIPTION	PRODUCT CODE	LIST PRICE		DIMENSIONS/INCHES		
		Gr1	Gr2	H	W	D
 Write Board Bridge Module - 6" High Single Sided	EVPW1SEB0618	251	259	6	18	3
	EVPW1SEB0624	292	302	6	24	3
	EVPW1SEB0630	327	334	6	30	3
	EVPW1SEB0636	371	384	6	36	3
	EVPW1SEB0642	420	429	6	42	3
	EVPW1SEB0648	457	529	6	48	3
	EVPW1SEB0654	515	529	6	54	3
	EVPW1SEB0660	542	556	6	60	3
Write Board Bridge Module - 12" High Single Sided	EVPW1SEB1218	251	259	12	18	3
	EVPW1SEB1224	292	302	12	24	3
	EVPW1SEB1230	327	334	12	30	3
	EVPW1SEB1236	371	384	12	36	3
	EVPW1SEB1242	420	429	12	42	3
	EVPW1SEB1248	457	471	12	48	3
	EVPW1SEB1254	515	529	12	54	3
	EVPW1SEB1260	542	556	12	60	3
Write Board Bridge Module - 18" High Single Sided	EVPW1SEB1818	335	348	18	18	3
	EVPW1SEB1824	395	409	18	24	3
	EVPW1SEB1830	455	471	18	30	3
	EVPW1SEB1836	520	537	18	36	3
	EVPW1SEB1842	587	604	18	42	3
	EVPW1SEB1848	644	662	18	48	3
	EVPW1SEB1854	697	721	18	54	3
	EVPW1SEB1860	767	792	18	60	3
Write Board Bridge Module - 24" High Single Sided	EVPW1SEB2418	335	348	24	18	3
	EVPW1SEB2424	395	409	24	24	3
	EVPW1SEB2430	455	471	24	30	3
	EVPW1SEB2436	520	537	24	36	3
	EVPW1SEB2442	587	604	24	42	3
	EVPW1SEB2448	644	662	24	48	3
	EVPW1SEB2454	697	721	24	54	3
	EVPW1SEB2460	767	792	24	60	3



EVPW2SEB - WRITE BOARD BRIDGE MODULE - DOUBLE SIDED

- Bridge modules connects two panels above opening.
- Requires bridge extension connectors, connects with clamps at bottom.
- Provides writing surface on Single side.
- Panel extension module is not load bearing if installed higher than 66" High.
- Available in high pressure only.
- Use erasable Write Board markers only.
- When ordering bridge modules, additional bridge connectors are required.
- Aluminum trim for bottom to be ordered separately.

DESCRIPTION	PRODUCT CODE	LIST PRICE	DIMENSIONS/INCHES		
			H	W	D
 Write Board Bridge Module - 6" High Double Sided	EVPW2SEB0618	270	6	18	3
	EVPW2SEB0624	319	6	24	3
	EVPW2SEB0630	368	6	30	3
	EVPW2SEB0636	422	6	36	3
	EVPW2SEB0642	479	6	42	3
	EVPW2SEB0648	534	6	48	3
	EVPW2SEB0654	616	6	54	3
	EVPW2SEB0660	632	6	60	3
Tempered Glass Bridge Module - 12" High Double Sided	EVPW2SEB1218	270	12	18	3
	EVPW2SEB1224	319	12	24	3
	EVPW2SEB1230	368	12	30	3
	EVPW2SEB1236	422	12	36	3
	EVPW2SEB1242	479	12	42	3
	EVPW2SEB1248	534	12	48	3
	EVPW2SEB1254	616	12	54	3
	EVPW2SEB1260	632	12	60	3
Tempered Glass Bridge Module - 18" High Double Sided	EVPW2SEB1818	388	18	18	3
	EVPW2SEB1824	469	18	24	3
	EVPW2SEB1830	542	18	30	3
	EVPW2SEB1836	629	18	36	3
	EVPW2SEB1842	710	18	42	3
	EVPW2SEB1848	805	18	48	3
	EVPW2SEB1854	882	18	54	3
	EVPW2SEB1860	950	18	60	3
Tempered Glass Bridge Module - 24" High Double Sided	EVPW2SEB2418	388	24	18	3
	EVPW2SEB2424	469	24	24	3
	EVPW2SEB2430	542	24	30	3
	EVPW2SEB2436	629	24	36	3
	EVPW2SEB2442	710	24	42	3
	EVPW2SEB2448	805	24	48	3
	EVPW2SEB2454	882	24	54	3
	EVPW2SEB2460	950	24	60	3

EVPH1SEB - LAMINATE BRIDGE MODULE - SINGLE SIDED

- Bridge modules connects two panels above opening.
- Requires bridge extension connectors, connects with clamps at bottom.
- Laminate face on module provides durable, washable surface on Single side of panel.
- Panel extension module is not load bearing if installed higher than 66" High.
- Available in high pressure only.
- When ordering bridge modules , additional bridge connectors are required.
- Aluminum trim for bottom to be ordered separately.

DESCRIPTION	PRODUCT CODE	LIST PRICE		DIMENSIONS/INCHES		
		Gr1	Gr2	H	W	D
 Laminate Bridge Module - 6" High Single Sided	EVPH1SEB0618	251	259	6	18	3
	EVPH1SEB0624	292	302	6	24	3
	EVPH1SEB0630	327	334	6	30	3
	EVPH1SEB0636	371	384	6	36	3
	EVPH1SEB0642	420	429	6	42	3
	EVPH1SEB0648	457	471	6	48	3
	EVPH1SEB0654	515	529	6	54	3
	EVPH1SEB0660	542	556	6	60	3
Laminate Bridge Module - 12" High Single Sided	EVPH1SEB1218	251	259	12	18	3
	EVPH1SEB1224	292	302	12	24	3
	EVPH1SEB1230	327	334	12	30	3
	EVPH1SEB1236	371	384	12	36	3
	EVPH1SEB1242	420	429	12	42	3
	EVPH1SEB1248	457	471	12	48	3
	EVPH1SEB1254	515	529	12	54	3
	EVPH1SEB1260	542	556	12	60	3
Laminate Bridge Module - 18" High Single Sided	EVPH1SEB1818	335	348	18	18	3
	EVPH1SEB1824	395	409	18	24	3
	EVPH1SEB1830	455	471	18	30	3
	EVPH1SEB1836	520	537	18	36	3
	EVPH1SEB1842	587	604	18	42	3
	EVPH1SEB1848	644	662	18	48	3
	EVPH1SEB1854	697	721	18	54	3
	EVPH1SEB1860	767	792	18	60	3
Laminate Bridge Module - 24" High Single Sided	EVPH1SEB2418	335	348	24	18	3
	EVPH1SEB2424	395	409	24	24	3
	EVPH1SEB2430	455	471	24	30	3
	EVPH1SEB2436	520	537	24	36	3
	EVPH1SEB2442	587	604	24	42	3
	EVPH1SEB2448	644	662	24	48	3
	EVPH1SEB2454	697	721	24	54	3
	EVPH1SEB2460	767	792	24	60	3



EVPH2SEB - LAMINATE BRIDGE MODULE - DOUBLE SIDED

- Bridge modules connects two panels above opening.
- Requires bridge extension connectors, connects with clamps at bottom.
- Laminate face on both sides of the module provides durable, washable surface.
- Panel extension module is not load bearing if installed higher than 66" High.
- When ordering panel extension modules, additional connectors are required.
- Available in high pressure only.
- When ordering bridge modules , additional bridge connectors are required.
- Aluminum trim for bottom to be ordered separately.

DESCRIPTION	PRODUCT CODE	LIST PRICE	DIMENSIONS/INCHES		
			H	W	D
 Laminate Bridge Module - 6" High Double Sided	EVPH2SEB0618	270	6	18	3
	EVPH2SEB0624	319	6	24	3
	EVPH2SEB0630	368	6	30	3
	EVPH2SEB0636	422	6	36	3
	EVPH2SEB0642	479	6	42	3
	EVPH2SEB0648	534	6	48	3
	EVPH2SEB0654	616	6	54	3
	EVPH2SEB0660	632	6	60	3
Laminate Bridge Module - 12" High Double Sided	EVPH2SEB1218	270	12	18	3
	EVPH2SEB1224	319	12	24	3
	EVPH2SEB1230	368	12	30	3
	EVPH2SEB1236	422	12	36	3
	EVPH2SEB1242	479	12	42	3
	EVPH2SEB1248	534	12	48	3
	EVPH2SEB1254	616	12	54	3
	EVPH2SEB1260	632	12	60	3
Laminate Bridge Module - 18" High Double Sided	EVPH2SEB1818	388	18	18	3
	EVPH2SEB1824	469	18	24	3
	EVPH2SEB1830	542	18	30	3
	EVPH2SEB1836	629	18	36	3
	EVPH2SEB1842	710	18	42	3
	EVPH2SEB1848	805	18	48	3
	EVPH2SEB1854	882	18	54	3
	EVPH2SEB1860	950	18	60	3
Laminate Bridge Module - 24" High Double Sided	EVPH2SEB2418	388	24	18	3
	EVPH2SEB2424	469	24	24	3
	EVPH2SEB2430	542	24	30	3
	EVPH2SEB2436	629	24	36	3
	EVPH2SEB2442	710	24	42	3
	EVPH2SEB2448	805	24	48	3
	EVPH2SEB2454	882	24	54	3
	EVPH2SEB2460	950	24	60	3

EVPMPXXGI6P - 6" H PANEL MOUNT PRIVACY GLASS W/ ALUMINUM TRIM

- Attaches on top of Evolve Panels to add privacy or divide space.
- Privacy Glass is integrated into the aluminum top trim.
- Aluminum trim must be specified for entire station when ordering panel mount privacy glass.
- Includes aluminum trim with channel and glass tile
- Glass and attachment hardware ship separately.
- Standard in clear (CLR) or frosted (FRST) glass.

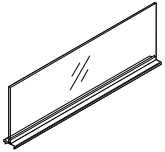
	DESCRIPTION	PRODUCT CODE	LIST PRICE		DIMENSIONS/INCHES		
			Clear	Frosted	H	W	D
	6" H Panel Mount Privacy Glass w/ Aluminum Trim - 24" Wide	EVPMP24GI6P	281	349	6	24	2 7/8
	6" H Panel Mount Privacy Glass w/ Aluminum Trim - 30" Wide	EVPMP30GI6P	304	353	6	30	2 7/8
	6" H Panel Mount Privacy Glass w/ Aluminum Trim - 36" Wide	EVPMP36GI6P	335	370	6	36	2 7/8
	6" H Panel Mount Privacy Glass w/ Aluminum Trim - 42" Wide	EVPMP42GI6P	350	408	6	42	2 7/8
	6" H Panel Mount Privacy Glass w/ Aluminum Trim - 48" Wide	EVPMP48GI6P	359	433	6	48	2 7/8
	6" H Panel Mount Privacy Glass w/ Aluminum Trim - 54" Wide	EVPMP54GI6P	372	467	6	54	2 7/8
	6" H Panel Mount Privacy Glass w/ Aluminum Trim - 60" Wide	EVPMP60GI6P	383	506	6	60	2 7/8
	6" H Panel Mount Privacy Glass w/ Aluminum Trim - 66" Wide	EVPMP66GI6P	443	590	6	66	2 7/8
6" H Panel Mount Privacy Glass w/ Aluminum Trim - 72" Wide	EVPMP72GI6P	456	603	6	72	2 7/8	



EVMPMPXXGI9P - 9"H PANEL MOUNT PRIVACY GLASS W/ ALUMINUM TRIM

- Attaches on top of Evolve Panels to add privacy or divide space.
- Privacy Glass is integrated into the aluminum top trim.
- Aluminum trim must be specified for entire station when ordering panel mount privacy glass.
- Includes aluminum trim with channel and glass tile
- Glass and attachment hardware ship separately.
- Standard in clear (CLR) or frosted (FRST) glass.

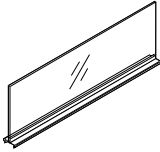
	DESCRIPTION	PRODUCT CODE	LIST PRICE		DIMENSIONS/INCHES		
			Clear	Frosted	H	W	D
	9" H Panel Mount Privacy Glass w/ Aluminum Trim - 24" Wide	EVMPMP24GI9P	281	349	9	24	2 7/8
	9" H Panel Mount Privacy Glass w/ Aluminum Trim - 30" Wide	EVMPMP30GI9P	304	353	9	30	2 7/8
	9" H Panel Mount Privacy Glass w/ Aluminum Trim - 36" Wide	EVMPMP36GI9P	335	370	9	36	2 7/8
	9" H Panel Mount Privacy Glass w/ Aluminum Trim - 42" Wide	EVMPMP42GI9P	350	408	9	42	2 7/8
	9" H Panel Mount Privacy Glass w/ Aluminum Trim - 48" Wide	EVMPMP48GI9P	359	433	9	48	2 7/8
	9" H Panel Mount Privacy Glass w/ Aluminum Trim - 54" Wide	EVMPMP54GI9P	372	467	9	54	2 7/8
	9" H Panel Mount Privacy Glass w/ Aluminum Trim - 60" Wide	EVMPMP60GI9P	383	506	9	60	2 7/8
	9" H Panel Mount Privacy Glass w/ Aluminum Trim - 66" Wide	EVMPMP66GI9P	443	590	9	66	2 7/8
9" H Panel Mount Privacy Glass w/ Aluminum Trim - 72" Wide	EVMPMP72GI9P	456	603	9	72	2 7/8	

EVPMPXXGIP - 12" PANEL MOUNT PRIVACY GLASS W/ ALUMINUM TRIM

- Attaches on top of Evolve Panels to add privacy or divide space.
- Privacy Glass is integrated into the aluminum top trim.
- Includes aluminum trim with channel and glass tile.
- Standard in clear (CLR), frosted (FRST) or writeable (WRW) glass.

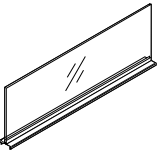
	DESCRIPTION	PRODUCT CODE	LIST PRICE			DIMENSIONS/INCHES		
			CLR	FRST	WRW	H	W	D
	Panel Mount Privacy Glass w/ Aluminum Trim - 24" Wide	EVPMP24GIP	290	358	473	12	24	2 7/8
	Panel Mount Privacy Glass w/ Aluminum Trim - 30" Wide	EVPMP30GIP	315	364	483	12	30	2 7/8
	Panel Mount Privacy Glass w/ Aluminum Trim - 36" Wide	EVPMP36GIP	335	370	494	12	36	2 7/8
	Panel Mount Privacy Glass w/ Aluminum Trim - 42" Wide	EVPMP42GIP	350	408	542	12	42	2 7/8
	Panel Mount Privacy Glass w/ Aluminum Trim - 48" Wide	EVPMP48GIP	369	442	593	12	48	2 7/8
	Panel Mount Privacy Glass w/ Aluminum Trim - 54" Wide	EVPMP54GIP	384	479	641	12	54	2 7/8
	Panel Mount Privacy Glass w/ Aluminum Trim - 60" Wide	EVPMP60GIP	395	518	690	12	60	2 7/8
	Panel Mount Privacy Glass w/ Aluminum Trim - 66" Wide	EVPMP66GIP	443	590	786	12	66	2 7/8
Panel Mount Privacy Glass w/ Aluminum Trim - 72" Wide	EVPMP72GIP	470	617	813	12	72	2 7/8	

EVPMPNXXGIP - 12" H PANEL MOUNT PRIVACY GLASS W/ NOTCHED TOP TRIM FOR INLINE VARIABLE HEIGHT CONNECTOR

- Privacy Glass integrated with aluminum top trim.
- Attaches on top of panels to add privacy or divide space.
- Includes aluminum top trim with channel with notched end and glass tile.
- Standard in clear (CLR) or frosted (FRST) glass.
- Aluminium trim must be specified for entire station when ordering panel mount privacy glass.
- Glass and attachment hardware to ship separately

	DESCRIPTION	PRODUCT CODE	LIST PRICE		DIMENSIONS/INCHES		
			Clear	Frosted	H	W	D
	Panel Mount Privacy Glass w/ Notched Top Trim for Variable Height Connector - 12" High	EVPMPN24GIP	290	356	12	24	2 7/8
		EVPMPN30GIP	315	364	12	30	2 7/8
		EVPMPN36GIP	335	368.5	12	36	2 7/8
		EVPMPN42GIP	350	408	12	42	2 7/8
		EVPMPN48GIP	369	442.8	12	48	2 7/8
		EVPMPN54GIP	384	479	12	54	2 7/8
		EVPMPN60GIP	395	518	12	60	2 7/8



EVPMPDNXXGIP - 12" H PANEL MOUNT PRIVACY GLASS W/ DOUBLE NOTCHED TOP TRIM FOR INLINE VARIABLE HEIGHT CONNECTOR

- Privacy Glass integrated with aluminum top trim.
- Attaches on top of panels to add privacy or divide space.
- Includes aluminum top trim with channel with notched ends and glass tile.
- Standard in clear (CLR) or frosted (FRST) glass.
- Aluminium trim must be specified for entire station when ordering panel mount privacy glass.
- Glass and attachment hardware to ship separately.

	DESCRIPTION	PRODUCT CODE	LIST PRICE		DIMENSIONS/INCHES		
			Clear	Frosted	H	W	D
	Panel Mount Privacy Glass w/ double notched top trim for variable height connector - 12" High	EVPMPDN24GIP	290	356	12	24	2 7/8
		EVPMPDN30GIP	315	364	12	30	2 7/8
		EVPMPDN36GIP	335	370	12	36	2 7/8
		EVPMPDN42GIP	350	408	12	42	2 7/8
		EVPMPDN48GIP	369	442.8	12	48	2 7/8
		EVPMPDN54GIP	384	479	12	54	2 7/8
		EVPMPDN60GIP	395	518	12	60	2 7/8

EVPMPXXGI18P - 18" H PANEL MOUNT PRIVACY GLASS

- Privacy Glass integrated with aluminum top trim.
- Attaches on top of panels to add privacy or divide space.
- Includes aluminum trim with channel and glass tile.
- Aluminium trim must be specified for entire station when ordering panel mount privacy glass.
- Glass and attachment hardware to ship separately.

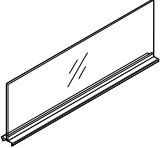
	DESCRIPTION	PRODUCT CODE	LIST PRICE		DIMENSIONS/INCHES		
			Clear	Frosted	H	W	D
	18" H Panel Mount Privacy Glass w/ Aluminum Trim - 24" Wide	EVPMP24G118P	433	530	18	24	2 7/8
	18" H Panel Mount Privacy Glass w/ Aluminum Trim - 30" Wide	EVPMP30G118P	470	543	18	30	2 7/8
	18" H Panel Mount Privacy Glass w/ Aluminum Trim - 36" Wide	EVPMP36G118P	501	551	18	36	2 7/8
	18" H Panel Mount Privacy Glass w/ Aluminum Trim - 42" Wide	EVPMP42G118P	523	607	18	42	2 7/8
	18" H Panel Mount Privacy Glass w/ Aluminum Trim - 48" Wide	EVPMP48G118P	554	663	18	48	2 7/8
	18" H Panel Mount Privacy Glass w/ Aluminum Trim - 54" Wide	EVPMP54G118P	574	719	18	54	2 7/8
	18" H Panel Mount Privacy Glass w/ Aluminum Trim - 60" Wide	EVPMP60G118P	593	775	18	60	2 7/8
	18" H Panel Mount Privacy Glass w/ Aluminum Trim - 66" Wide	EVPMP66G118P	665	881	18	66	2 7/8
	18" H Panel Mount Privacy Glass w/ Aluminum Trim - 72" Wide	EVPMP72G118P	703	920	18	72	2 7/8

EVPMPNXXG118P - 18" H PANEL MOUNT PRIVACY GLASS WITH NOTCHED TOP TRIM FOR VARIABLE HEIGHT CONNECTOR

- Privacy Glass integrated with aluminum top trim.
- Attaches on top of panels to add privacy or divide space.
- Includes aluminum trim with channel and glass tile.
- Standard in clear (CLR) or frosted (FRST) glass.
- Aluminium trim must be specified for entire station when ordering panel mount privacy glass.
- Glass and attachment hardware to ship separately.

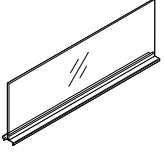
	DESCRIPTION	PRODUCT CODE	LIST PRICE		DIMENSIONS/INCHES		
			Clear	Frosted	H	W	D
	18" H Panel Mount Privacy Glass w/ Aluminum Trim - 24" Wide	EVPMPN24G118P	433	530	18	24	2 7/8
	18" H Panel Mount Privacy Glass w/ Aluminum Trim - 30" Wide	EVPMPN30G118P	470	543	18	30	2 7/8
	18" H Panel Mount Privacy Glass w/ Aluminum Trim - 36" Wide	EVPMPN36G118P	501	551	18	36	2 7/8
	18" H Panel Mount Privacy Glass w/ Aluminum Trim - 42" Wide	EVPMPN42G118P	523	607	18	42	2 7/8
	18" H Panel Mount Privacy Glass w/ Aluminum Trim - 48" Wide	EVPMPN48G118P	554	663	18	48	2 7/8
	18" H Panel Mount Privacy Glass w/ Aluminum Trim - 54" Wide	EVPMPN54G118P	574	719	18	54	2 7/8
	18" H Panel Mount Privacy Glass w/ Aluminum Trim - 60" Wide	EVPMPN60G118P	593	775	18	60	2 7/8
	18" H Panel Mount Privacy Glass w/ Aluminum Trim - 66" Wide	EVPMPN66G118P	665	881	18	66	2 7/8
18" H Panel Mount Privacy Glass w/ Aluminum Trim - 72" Wide	EVPMPN72G118P	703	920	18	72	2 7/8	



EVMPDPNXXGI18P-18"H PANEL MOUNT PRIVACY GLASS WITH DOUBLE NOTCHED TOP TRIM FOR VARIABLE HEIGHT CONNECTOR

- Privacy Glass integrated with aluminum top trim.
- Attaches on top of panels to add privacy or divide space.
- Includes aluminum trim with channel and glass tile.
- Standard in clear (CLR) or frosted (FRST) glass.
- Aluminium trim must be specified for entire station when ordering panel mount privacy glass.
- Glass and attachment hardware to ship separately.

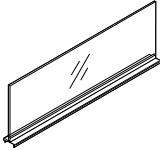
	DESCRIPTION	PRODUCT CODE	LIST PRICE		DIMENSIONS/INCHES		
			Clear	Frosted	H	W	D
	18" H Panel Mount Privacy Glass w/ Aluminum Trim - 24" Wide	EVMPDPN24GI18P	433	530	18	24	2 7/8
	18" H Panel Mount Privacy Glass w/ Aluminum Trim - 30" Wide	EVMPDPN30GI18P	470	543	18	30	2 7/8
	18" H Panel Mount Privacy Glass w/ Aluminum Trim - 36" Wide	EVMPDPN36GI18P	501	551	18	36	2 7/8
	18" H Panel Mount Privacy Glass w/ Aluminum Trim - 42" Wide	EVMPDPN42GI18P	523	607	18	42	2 7/8
	18" H Panel Mount Privacy Glass w/ Aluminum Trim - 48" Wide	EVMPDPN48GI18P	554	663	18	48	2 7/8
	18" H Panel Mount Privacy Glass w/ Aluminum Trim - 54" Wide	EVMPDPN54GI18P	574	719	18	54	2 7/8
	18" H Panel Mount Privacy Glass w/ Aluminum Trim - 60" Wide	EVMPDPN60GI18P	593	775	18	60	2 7/8
	18" H Panel Mount Privacy Glass w/ Aluminum Trim - 66" Wide	EVMPDPN66GI18P	665	881	18	66	2 7/8
	18" H Panel Mount Privacy Glass w/ Aluminum Trim - 72" Wide	EVMPDPN72GI18P	703	920	18	72	2 7/8

EVPMPXXGI6PU - 6" H PANEL MOUNT PRIVACY GLASS FOR U CHANNEL FOR GALLERY PANEL ON ONE END

- Privacy Glass integrated with aluminum top trim to be used with U channel with connector for Gallery Panels.
- Attaches on top of panels to add privacy or divide space.
- Includes aluminum trim with channel and glass tile.
- Standard in clear (CLR) or frosted (FRST) glass.
- Aluminium trim must be specified for entire station when ordering panel mount privacy glass.
- Glass and attachment hardware to ship separately.
- Trim and glass extended for U channel from one end.

DESCRIPTION	PRODUCT CODE	LIST PRICE		DIMENSIONS/INCHES		
		Clear	Frosted	H	W	D
 6" H Panel Mount Privacy Glass U Channel for Gallery Panel	EVPMP24GI6PU	324	372	6	24	5/8
	EVPMP30GI6PU	347	421	6	30	5/8
	EVPMP36GI6PU	360	418	6	36	5/8
	EVPMP42GI6PU	382	456	6	42	5/8
	EVPMP48GI6PU	395	492	6	48	5/8
	EVPMP54GI6PU	407	533	6	54	5/8
	EVPMP60GI6PU	443	589	6	60	5/8
	EVPMP66GI6PU	470	615	6	66	5/8
	EVPMP72GI6PU	497	639	6	72	5/8

EVPMPXXGI9PU - 9" H PANEL MOUNT PRIVACY GLASS FOR U CHANNEL FOR GALLERY PANEL ON ONE END

- Privacy Glass integrated with aluminum top trim to be used with U channel with connector for Gallery Panels.
- Attaches on top of panels to add privacy or divide space.
- Includes aluminum trim with channel and glass tile.
- Standard in clear (CLR) or frosted (FRST) glass.
- Aluminium trim must be specified for entire station when ordering panel mount privacy glass.
- Glass and attachment hardware to ship separately.
- Trim and glass extended for U channel from one end.

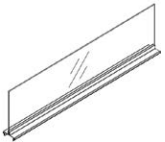
DESCRIPTION	PRODUCT CODE	LIST PRICE		DIMENSIONS/INCHES		
		Clear	Frosted	H	W	D
 9" H Panel Mount Privacy Glass U Channel for Gallery Panel	EVPMP24GI9PU	324	372	9	24	5/8
	EVPMP30GI9PU	378	421	9	30	5/8
	EVPMP36GI9PU	416	418	9	36	5/8
	EVPMP42GI9PU	455	456	9	42	5/8
	EVPMP48GI9PU	492	492	9	48	5/8
	EVPMP54GI9PU	532	533	9	54	5/8
	EVPMP60GI9PU	443	589	9	60	5/8
	EVPMP66GI9PU	470	615	9	66	5/8
	EVPMP72GI9PU	497	639	9	72	5/8

EVPMPXXGI12PU - 12" H PANEL MOUNT PRIVACY GLASS FOR U CHANNEL FOR GALLERY PANEL ON ONE END

- Privacy Glass integrated with aluminum top trim to be used with U channel with connector for Gallery Panels.
- Attaches on top of panels to add privacy or divide space.
- Includes aluminum trim with channel and glass tile.
- Standard in clear (CLR) or frosted (FRST) glass.
- Aluminium trim must be specified for entire station when ordering panel mount privacy glass.
- Glass and attachment hardware to ship separately.
- Trim and glass extended for U channel from one end.

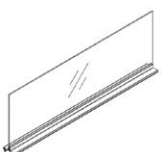
DESCRIPTION	PRODUCT CODE	LIST PRICE		DIMENSIONS/INCHES		
		Clear	Frosted	H	W	D
 12" H Panel Mount Privacy Glass U Channel for Gallery Panel	EVPMP24GI12PU	324	372	12	24	5/8
	EVPMP30GI12PU	347	421	12	30	5/8
	EVPMP36GI12PU	360	418	12	36	5/8
	EVPMP42GI12PU	382	456	12	42	5/8
	EVPMP48GI12PU	395	492	12	48	5/8
	EVPMP54GI12PU	407	533	12	54	5/8
	EVPMP60GI12PU	443	589	12	60	5/8
	EVPMP66GI12PU	470	615	12	66	5/8
	EVPMP72GI12PU	497	639	12	72	5/8



EVPMPXXGI18PU - 18" H PANEL MOUNT PRIVACY GLASS FOR U CHANNEL FOR GALLERY PANEL ON ONE END

- Privacy Glass integrated with aluminum top trim to be used with U channel with connector for Gallery Panels.
- Attaches on top of panels to add privacy or divide space.
- Includes aluminum trim with channel and glass tile.
- Standard in clear (CLR) or frosted (FRST) glass.
- Aluminium trim must be specified for entire station when ordering panel mount privacy glass.
- Glass and attachment hardware to ship separately.
- Trim and glass extended for U channel from one end.

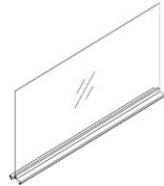

DESCRIPTION	PRODUCT CODE	LIST PRICE		DIMENSIONS/INCHES		
		Clear	Frosted	H	W	D
18" H Panel Mount Privacy Glass U Channel for Gallery Panel	EVPMP24GI18PU	470	541	18	24	5/8
	EVPMP30GI18PU	501	550	18	30	5/8
	EVPMP36GI18PU	523	572	18	36	5/8
	EVPMP42GI18PU	554	662	18	42	5/8
	EVPMP48GI18PU	574	715	18	48	5/8
	EVPMP54GI18PU	593	773	18	54	5/8
	EVPMP60GI18PU	665	878	18	60	5/8
	EVPMP66GI18PU	703	919	18	66	5/8
	EVPMP72GI18PU	743	960	18	72	5/8

EVPMPXXGI6PDU - 6" H PANEL MOUNT PRIVACY GLASS FOR U CHANNEL FOR GALLERY PANELS ON BOTH ENDS

- Privacy Glass integrated with aluminum top trim to be used with U channel with connector for Gallery Panels.
- Attaches on top of panels to add privacy or divide space.
- Includes aluminum trim with channel and glass tile.
- Standard in clear (CLR) or frosted (FRST) glass.
- Aluminium trim must be specified for entire station when ordering panel mount privacy glass.
- Glass and attachment hardware to ship separately.
- Trim and glass extended for U channel from both ends.



DESCRIPTION	PRODUCT CODE	LIST PRICE		DIMENSIONS/INCHES		
		Clear	Frosted	H	W	D
6" H Panel Mount Privacy Glass U Channel for Gallery Panel	EVPMP24GI6PDU	324	372	6	25	1/4
	EVPMP30GI6PDU	344	378.4	6	31	1/4
	EVPMP36GI6PDU	360	418	6	37	1/4
	EVPMP42GI6PDU	381	456	6	43	1/4
	EVPMP48GI6PDU	395	492	6	49	1/4
	EVPMP54GI6PDU	407	533	6	55	1/4
	EVPMP60GI6PDU	443	589	6	61	1/4
	EVPMP66GI6PDU	470	615	6	67	1/4
	EVPMP72GI6PDU	497	639	6	73	1/4

EVPMPXXGI9PDU - 9" H PANEL MOUNT PRIVACY GLASS FOR U CHANNEL FOR GALLERY PANELS ON BOTH ENDS

- Privacy Glass integrated with aluminum top trim to be used with U channel with connector for Gallery Panels.
- Attaches on top of panels to add privacy or divide space.
- Includes aluminum trim with channel and glass tile.
- Standard in clear (CLR) or frosted (FRST) glass.
- Aluminium trim must be specified for entire station when ordering panel mount privacy glass.
- Glass and attachment hardware to ship separately.
- Trim and glass extended for U channel from both ends.

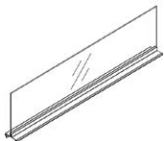

DESCRIPTION	PRODUCT CODE	LIST PRICE		DIMENSIONS/INCHES		
		Clear	Frosted	H	W	D
9" H Panel Mount Privacy Glass U Channel for Gallery Panel	EVPMP24GI9PDU	324	372	9	25	1/4
	EVPMP30GI9PDU	344	378.4	9	31	1/4
	EVPMP36GI9PDU	360	418	9	37	1/4
	EVPMP42GI9PDU	381	456	9	43	1/4
	EVPMP48GI9PDU	395	492	9	49	1/4
	EVPMP54GI9PDU	407	533	9	55	1/4
	EVPMP60GI9PDU	443	589	9	61	1/4
	EVPMP66GI9PDU	470	615	9	67	1/4
	EVPMP72GI9PDU	497	639	9	73	1/4

EVPMPXXGIPDU - 12" H PANEL MOUNT PRIVACY GLASS FOR U CHANNEL FOR GALLERY PANELS ON BOTH ENDS

- Privacy Glass integrated with aluminum top trim to be used with U channel with connector for Gallery Panels.
- Attaches on top of panels to add privacy or divide space.
- Includes aluminum trim with channel and glass tile.
- Standard in clear (CLR) or frosted (FRST) glass.
- Aluminium trim must be specified for entire station when ordering panel mount privacy glass.
- Glass and attachment hardware to ship separately.
- Trim and glass extended for U channel from both ends.

	DESCRIPTION	PRODUCT CODE	LIST PRICE		DIMENSIONS/INCHES		
			Clear	Frosted	H	W	D
	12" H Panel Mount Privacy Glass	EVPMP24GIPDU	324	372	12	25 1/4	
	U Channel for Gallery Panel	EVPMP30GIPDU	344	378.4	12	31 1/4	
		EVPMP36GIPDU	360	418	12	37 1/4	
		EVPMP42GIPDU	381	456	12	43 1/4	
		EVPMP48GIPDU	395	492	12	49 1/4	
		EVPMP54GIPDU	407	533	12	55 1/4	
		EVPMP60GIPDU	443	589	12	61 1/4	
		EVPMP66GIPDU	470	615	12	67 1/4	
		EVPMP72GIPDU	497	639	12	73 1/4	

EVPMPXXGI18PDU - 18" H PANEL MOUNT PRIVACY GLASS FOR U CHANNEL FOR GALLERY PANELS ON BOTH ENDS

- Privacy Glass integrated with aluminum top trim to be used with U channel with connector for Gallery Panels.
- Attaches on top of panels to add privacy or divide space.
- Includes aluminum trim with channel and glass tile.
- Standard in clear (CLR) or frosted (FRST) glass.
- Aluminium trim must be specified for entire station when ordering panel mount privacy glass.
- Glass and attachment hardware to ship separately.
- Trim and glass extended for U channel from both ends.

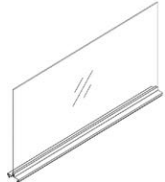
	DESCRIPTION	PRODUCT CODE	LIST PRICE		DIMENSIONS/INCHES		
			Clear	Frosted	H	W	D
	18" H Panel Mount Privacy Glass	EVPMP24GI18PDU	471	540	18	25 1/4	
	U Channel for Gallery Panel	EVPMP30GI18PDU	501	550	18	31 1/4	
		EVPMP36GI18PDU	522	607	18	37 1/4	
		EVPMP42GI18PDU	554	662	18	43 1/4	
		EVPMP48GI18PDU	574	715	18	49 1/4	
		EVPMP54GI18PDU	593	773	18	55 1/4	
		EVPMP60GI18PDU	664	880	18	61 1/4	
		EVPMP66GI18PDU	704	917	18	67 1/4	
		EVPMP72GI18PDU	743	817	18	73 1/4	



EVMPMPXXGI6W - 6" H PRIVACY GLASS W/ ALUMINUM TRIM FOR 1" LAMINATE PANEL

- Attaches on top of Evolve 1" Laminate Panels to add privacy or divide space.
- Privacy Glass is integrated into the aluminum top trim.
- Aluminum trim has rail for accessories.
- Includes aluminum trim with end caps and glass tile
- Glass and attachment hardware ship separately.
- Standard in clear (CLR) or frosted (FRST) glass.

	DESCRIPTION	PRODUCT CODE	LIST PRICE		DIMENSIONS/INCHES		
			Clear	Frosted	H	W	D
	6" H Privacy Glass w/ Aluminum Trim for 1" Laminate Panel - 24" Wide	EVMPMP24GI6W	290	358	6	24	1
	6" H Privacy Glass w/ Aluminum Trim for 1" Laminate Panel- 30" Wide	EVMPMP30GI6W	315	364	6	30	1
	6" H Privacy Glass w/ Aluminum Trim for 1" Laminate Panel - 36" Wide	EVMPMP36GI6W	335	370	6	36	1
	6" H Privacy Glass w/ Aluminum Trim for 1" Laminate Panel- 42" Wide	EVMPMP42GI6W	350	408	6	42	1
	6" H Privacy Glass w/ Aluminum Trim for 1" Laminate Panel- 48" Wide	EVMPMP48GI6W	369	442.8	6	48	1

EVMPMPXXGI9W - 9" H PRIVACY GLASS W/ ALUMINUM TRIM FOR 1" LAMINATE PANEL

- Attaches on top of Evolve 1" Laminate Panels to add privacy or divide space.
- Privacy Glass is integrated into the aluminum top trim.
- Aluminum trim has rail for accessories.
- Includes aluminum trim with end caps and glass tile
- Glass and attachment hardware ship separately.
- Standard in clear (CLR) or frosted (FRST) glass.

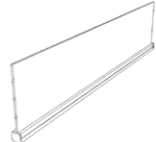
	DESCRIPTION	PRODUCT CODE	LIST PRICE		DIMENSIONS/INCHES		
			Clear	Frosted	H	W	D
	9" H Privacy Glass w/ Aluminum Trim for 1" Laminate Panel - 24" Wide	EVMPMP24GI9W	290	358	9	24	1
	9" H Privacy Glass w/ Aluminum Trim for 1" Laminate Panel- 30" Wide	EVMPMP30GI9W	315	364	9	30	1
	9" H Privacy Glass w/ Aluminum Trim for 1" Laminate Panel - 36" Wide	EVMPMP36GI9W	335	370	9	36	1
	9" H Privacy Glass w/ Aluminum Trim for 1" Laminate Panel- 42" Wide	EVMPMP42GI9W	350	408	9	42	1
	9" H Privacy Glass w/ Aluminum Trim for 1" Laminate Panel- 48" Wide	EVMPMP48GI9W	369	442.8	9	48	1

EVPMPXXGIW - 12" H PRIVACY GLASS W/ ALUMINUM TRIM FOR 1" LAMINATE PANEL

- Attaches on top of Evolve 1" Laminate Panels to add privacy or divide space.
- Privacy Glass is integrated into the aluminum top trim.
- Aluminum trim has rail for accessories.
- Includes aluminum trim with end caps and glass tile
- Glass and attachment hardware ship separately.
- Standard in clear (CLR), frosted (FRST) or writeable (WRW) glass.

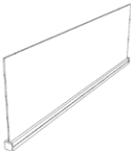
	DESCRIPTION	PRODUCT CODE	LIST PRICE			DIMENSIONS/INCHES		
			CLR	FRST	WRW	H	W	D
	12" H Privacy Glass w/ Aluminum Trim for 1" Laminate Panel - 24" Wide	EVPMP24GIW	290	358	473	12	24	1
	12" H Privacy Glass w/ Aluminum Trim for 1" Laminate Panel - 30" Wide	EVPMP30GIW	315	364	483	12	30	1
	12" H Privacy Glass w/ Aluminum Trim for 1" Laminate Panel - 36" Wide	EVPMP36GIW	335	370	493	12	36	1
	12" H Privacy Glass w/ Aluminum Trim for 1" Laminate Panel - 42" Wide	EVPMP42GIW	350	408	542	12	42	1
	12" H Privacy Glass w/ Aluminum Trim for 1" Laminate Panel - 48" Wide	EVPMP48GIW	369	408	592	12	48	1

EVFPFDW - 6" H FELT DIVIDER W/ ALUMINUM TRIM FOR 1" LAMINATE PANEL

- Privacy Felt Divider integrated with aluminum top trim.
- Attaches on top of laminate panels to add privacy or divide space.
- Includes aluminum trim with channel and felt tile.
- Felt and attachment hardware to ship separately.
- 9 mm felt material is tackable and comes in 9 different colors. Please specify color.
- Aluminum top trim available in standard paint finishes.

	DESCRIPTION	PRODUCT CODE	LIST PRICE	DIMENSIONS/INCHES		
				H	W	D
	6" H Felt Divider w/ Aluminum Trim for 1" Laminate Panel	EVFPD0624W	116	6	24	1
		EVFPD0630W	135	6	30	1
		EVFPD0636W	160	6	36	1
		EVFPD0642W	180	6	42	1
		EVFPD0648W	264	6	48	1
		EVFPD0654W	289	6	54	1
		EVFPD0660W	310	6	60	1
		EVFPD0666W	327	6	66	1
		EVFPD0672W	369	6	72	1

EVFPFDW - 9" H FELT DIVIDER W/ ALUMINUM TRIM FOR 1" LAMINATE PANEL

- Privacy Felt Divider integrated with aluminum top trim.
- Attaches on top of laminate panels to add privacy or divide space.
- Includes aluminum trim with channel and felt tile.
- Felt and attachment hardware to ship separately.
- 9 mm felt material is tackable and comes in 9 different colors. Please specify color.
- Aluminum top trim available in standard paint finishes.

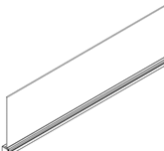
	DESCRIPTION	PRODUCT CODE	LIST PRICE	DIMENSIONS/INCHES		
				H	W	D
	9" H Felt Divider w/ Aluminum Trim for 1" Laminate Panel	EVFPD0924W	116	9	24	1
		EVFPD0930W	135	9	30	1
		EVFPD0936W	160	9	36	1
		EVFPD0942W	180	9	42	1
		EVFPD0948W	264	9	48	1
		EVFPD0954W	289	9	54	1
		EVFPD0960W	310	9	60	1
		EVFPD0966W	327	9	66	1
		EVFPD0972W	369	9	72	1



EVFPDW - 12" H FELT DIVIDER W/ ALUMINUM TRIM FOR 1" LAMINATE PANEL

- Privacy Felt Divider integrated with aluminum top trim.
- Attaches on top of laminate panels to add privacy or divide space.
- Includes aluminum trim with channel and felt tile.
- Felt and attachment hardware to ship separately.
- 9 mm felt material is tackable and comes in 9 different colors. Please specify color.
- Aluminum top trim available in standard paint finishes.

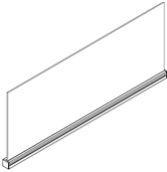
DESCRIPTION	PRODUCT CODE	LIST PRICE	DIMENSIONS/INCHES		
			H	W	D
 <p>12" H Felt Divider w/ Aluminum Trim for 1" Laminate Panel</p>	EVFPD1224W	116	12	24	1
	EVFPD1230W	135	12	30	1
	EVFPD1236W	160	12	36	1
	EVFPD1242W	180	12	42	1
	EVFPD1248W	264	12	48	1
	EVFPD1254W	289	12	54	1
	EVFPD1260W	310	12	60	1
	EVFPD1266W	327	12	66	1
	EVFPD1272W	369	12	72	1

EVFPDW - 18" H FELT DIVIDER W/ ALUMINUM TRIM FOR 1" LAMINATE PANEL

- Privacy Felt Divider integrated with aluminum top trim.
- Attaches on top of laminate panels to add privacy or divide space.
- Includes aluminum trim with channel and felt tile.
- Felt and attachment hardware to ship separately.
- 9 mm felt material is tackable and comes in 9 different colors. Please specify color.
- Aluminum top trim available in standard paint finishes.

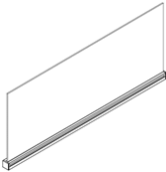
DESCRIPTION	PRODUCT CODE	LIST PRICE	DIMENSIONS/INCHES		
			H	W	D
 <p>18" H Felt Divider w/ Aluminum Trim for 1" Laminate Panel</p>	EVFPD1824W	145	18	24	1
	EVFPD1830W	169	18	30	1
	EVFPD1836W	200	18	36	1
	EVFPD1842W	223	18	42	1
	EVFPD1848W	329	18	48	1
	EVFPD1854W	359	18	54	1
	EVFPD1860W	388	18	60	1
	EVFPD1866W	407	18	66	1
	EVFPD1872W	462	18	72	1

EVFDK06P - 6" PANEL MOUNTED FELT DIVIDER

- Privacy felt panel integrated with aluminum top trim.
- Attaches on top of panels to add privacy or divide space. Includes aluminum trim with channel and felt tile.
- Aluminum trim must be specified for entire station when ordering panel mount privacy felt.
- Felt and attachment hardware to ship separately.
- 9mm thick Felt material is tackable and comes in 9 different colors. Please specify color. Graphite (GPH), Mist (MTS), Pewter (PWT), Harvest (HVT), Shamrock (SHR), Brick (BRI), Denim (DEN), Black (BLK) or White (WHT).

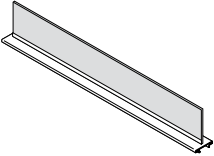
DESCRIPTION	PRODUCT CODE	LIST PRICE Gr1	DIMENSIONS/INCHES		
			H	W	D
 <p>6" Privacy felt panel integrated with aluminum top trim</p>	EVFDK0624P	116	6	24	2 7/8
	EVFDK0630P	135	6	30	2 7/8
	EVFDK0636P	160	6	36	2 7/8
	EVFDK0642P	180	6	42	2 7/8
	EVFDK0648P	264	6	48	2 7/8
	EVFDK0654P	289	6	54	2 7/8
	EVFDK0660P	310	6	60	2 7/8
	EVFDK0666P	327	6	66	2 7/8
	EVFDK0672P	369	6	72	2 7/8

EVFDK09P - 9" PANEL MOUNTED FELT DIVIDER

- Privacy felt panel integrated with aluminum top trim.
- Attaches on top of panels to add privacy or divide space. Includes aluminum trim with channel and felt tile.
- Aluminum trim must be specified for entire station when ordering panel mount privacy felt.
- Felt and attachment hardware to ship separately.
- 9mm thick Felt material is tackable and comes in 9 different colors. Please specify color. Graphite (GPH), Mist (MTS), Pewter (PWT), Harvest (HVT), Shamrock (SHR), Brick (BRI), Denim (DEN), Black (BLK) or White (WHT).

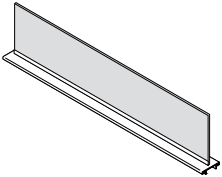
DESCRIPTION	PRODUCT CODE	LIST PRICE Gr1	DIMENSIONS/INCHES		
			H	W	D
 <p>9" Privacy felt panel integrated with aluminum top trim</p>	EVFDK0924P	116	9	24	2 7/8
	EVFDK0930P	135	9	30	2 7/8
	EVFDK0936P	160	9	36	2 7/8
	EVFDK0942P	180	9	42	2 7/8
	EVFDK0948P	264	9	48	2 7/8
	EVFDK0954P	289	9	54	2 7/8
	EVFDK0960P	310	9	60	2 7/8
	EVFDK0966P	327	9	66	2 7/8
	EVFDK0972P	369	9	72	2 7/8

EVFDK12P - 12" PANEL MOUNTED FELT DIVIDER

- Privacy felt panel integrated with aluminum top trim.
- Attaches on top of panels to add privacy or divide space. Includes aluminum trim with channel and felt tile.
- Aluminum trim must be specified for entire station when ordering panel mount privacy felt.
- Felt and attachment hardware to ship separately.
- 9mm thick Felt material is tackable and comes in 9 different colors. Please specify color. Graphite (GPH), Mist (MTS), Pewter (PWT), Harvest (HVT), Shamrock (SHR), Brick (BRI), Denim (DEN), Black (BLK) or White (WHT).

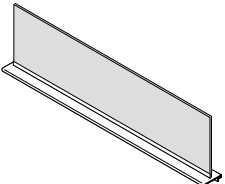
DESCRIPTION	PRODUCT CODE	LIST PRICE Gr1	DIMENSIONS/INCHES		
			H	W	D
 <p>12" Privacy felt panel integrated with aluminum top trim</p>	EVFDK1224P	116	12	24	2 7/8
	EVFDK1230P	135	12	30	2 7/8
	EVFDK1236P	160	12	36	2 7/8
	EVFDK1242P	180	12	42	2 7/8
	EVFDK1248P	264	12	48	2 7/8
	EVFDK1254P	289	12	54	2 7/8
	EVFDK1260P	310	12	60	2 7/8



EVFDK12PN - 12" PANEL MOUNTED FELT DIVIDER, 1 NOTCH

- Privacy felt panel integrated with aluminum top trim.
- Attaches on top of panels to add privacy or divide space. Includes aluminum trim with channel and felt tile.
- Aluminum trim must be specified for entire station when ordering panel mount privacy felt.
- Felt and attachment hardware to ship separately.
- 9mm thick Felt material is tackable and comes in 9 different colors. Please specify color. Graphite (GPH), Mist (MTS), Pewter (PWT), Harvest (HVT), Shamrock (SHR), Brick (BRI), Denim (DEN), Black (BLK) or White (WHT).

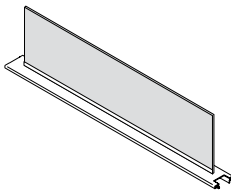
DESCRIPTION	PRODUCT CODE	LIST PRICE Gr1	DIMENSIONS/INCHES		
			H	W	D
 <p>12" Privacy felt panel integrated with aluminum top trim with 1 Notch</p>	EVFDK1224PN	116	12	22.68	2 7/8
	EVFDK1230PN	135	12	28.68	2 7/8
	EVFDK1236PN	160	12	34.68	2 7/8
	EVFDK1242PN	180	12	40.68	2 7/8
	EVFDK1248PN	264	12	46.68	2 7/8
	EVFDK1254PN	289	12	52.68	2 7/8
	EVFDK1260PN	310	12	58.68	2 7/8

EVFDK12PDN - 12" PANEL MOUNTED FELT DIVIDER, 2 NOTCHES

- Privacy felt panel integrated with aluminum top trim.
- Attaches on top of panels to add privacy or divide space. Includes aluminum trim with channel and felt tile.
- Aluminum trim must be specified for entire station when ordering panel mount privacy felt.
- Felt and attachment hardware to ship separately.
- 9mm thick Felt material is tackable and comes in 9 different colors. Please specify color. Graphite (GPH), Mist (MTS), Pewter (PWT), Harvest (HVT), Shamrock (SHR), Brick (BRI), Denim (DEN), Black (BLK) or White (WHT).

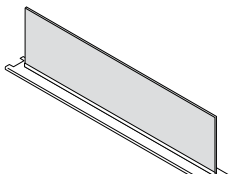
DESCRIPTION	PRODUCT CODE	LIST PRICE Gr1	DIMENSIONS/INCHES		
			H	W	D
 <p>12" Privacy felt panel integrated with aluminum top trim with 2 Notches</p>	EVFDK1224PDN	116	12	21.44	2 7/8
	EVFDK1230PDN	135	12	27.44	2 7/8
	EVFDK1236PDN	160	12	33.44	2 7/8
	EVFDK1242PDN	180	12	39.44	2 7/8
	EVFDK1248PDN	264	12	45.44	2 7/8
	EVFDK1254PDN	289	12	51.44	2 7/8
	EVFDK1260PDN	310	12	57.44	2 7/8

EVFDK18P - 18" PANEL MOUNTED FELT DIVIDER

- Privacy felt panel integrated with aluminum top trim.
- Attaches on top of panels to add privacy or divide space. Includes aluminum trim with channel and felt tile.
- Aluminum trim must be specified for entire station when ordering panel mount privacy felt.
- Felt and attachment hardware to ship separately.
- 9mm thick Felt material is tackable and comes in 9 different colors. Please specify color. Graphite (GPH), Mist (MTS), Pewter (PWT), Harvest (HVT), Shamrock (SHR), Brick (BRI), Denim (DEN), Black (BLK) or White (WHT).

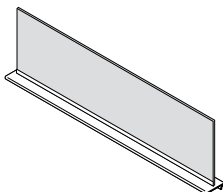
DESCRIPTION	PRODUCT CODE	LIST PRICE Gr1	DIMENSIONS/INCHES		
			H	W	D
 <p>18" Privacy felt panel integrated with aluminum top trim</p>	EVFDK01824P	145	18	24	2 7/8
	EVFDK01830P	169	18	30	2 7/8
	EVFDK01836P	200	18	36	2 7/8
	EVFDK01842P	223	18	42	2 7/8
	EVFDK01848P	325	18	48	2 7/8
	EVFDK01854P	359	18	54	2 7/8
	EVFDK01860P	388	18	60	2 7/8
	EVFDK01866P	407	18	66	2 7/8
	EVFDK01872P	462	18	72	2 7/8

EVFPDK06XXPCF - 6" H PANEL MOUNT PRIVACY DIVIDER CEILING FILLER KIT

- Privacy Felt Divider integrated with aluminum top trim.
- Aluminum top trim available in standard paint finishes.
- Attaches on top of panels to add privacy or divide space.
- Includes aluminum trim with channel and Felt tile.
- Felt tile and attachment hardware to ship separately.
- Felt material available in Graphite (GPH), Mist (MTS), Pewter (PWT), Harvest (HVT), Shamrock (SHR), Brick (BRI), Denim (DEN), Black (BLK) or White (WHT).
- PVC cap for closing gap at ceiling included.
- PVC cap available in white only.

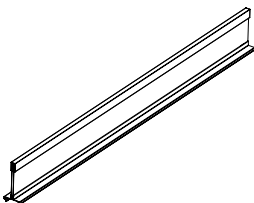
DESCRIPTION	PRODUCT CODE	LIST PRICE	DIMENSIONS/INCHES		
			H	W	D
 Panel Mount Felt Divider Ceiling Filler Kit	EVFPDK0618PCF	110	6	18	
	EVFPDK0624PCF	131	6	24	
	EVFPDK0630PCF	156	6	30	
	EVFPDK0636PCF	183	6	36	
	EVFPDK0642PCF	206	6	42	
	EVFPDK0648PCF	304	6	48	
	EVFPDK0654PCF	329	6	54	
	EVFPDK0660PCF	358	6	60	
	EVFPDK0666PCF	376	6	66	
	EVFPDK0672PCF	424	6	72	

EVFPDK06XXPCFP - 6" H PANEL MOUNT PRIVACY DIVIDER CEILING FILLER KIT

- Privacy Felt Divider integrated with aluminum top trim.
- Aluminum top trim available in standard paint finishes.
- Aluminum trim is width of panel.
- Attaches on top of panels to add privacy or divide space.
- Includes aluminum trim with channel and Felt tile.
- Felt tile and attachment hardware to ship separately.
- Felt material available in Graphite (GPH), Mist (MTS), Pewter (PWT), Harvest (HVT), Shamrock (SHR), Brick (BRI), Denim (DEN), Black (BLK) or White (WHT).
- Felt tile is longer and overhangs half of width of post.
- PVC cap for closing gap at ceiling included.
- PVC cap available in white only.

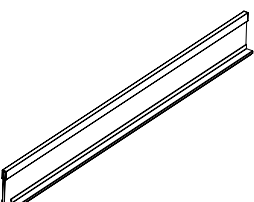
DESCRIPTION	PRODUCT CODE	LIST PRICE	DIMENSIONS/INCHES		
			H	W	D
 Panel Mount Felt Divider Ceiling Filler at Post Kit	EVFPDK0619PCF	131	6	19 3/4	
	EVFPDK0625PCF	156	6	25 3/4	
	EVFPDK0631PCF	183	6	31 3/4	
	EVFPDK0637PCF	206	6	37 3/4	
	EVFPDK0643PCF	304	6	43 3/4	
	EVFPDK0649PCF	329	6	49 3/4	
	EVFPDK0655PCF	358	6	55 3/4	
	EVFPDK0661PCF	376	6	61 3/4	
	EVFPDK0667PCF	424	6	67 3/4	
	EVFPDK0673PCF	475	6	73 3/4	

EVFPDK09XXPCF - 9" H PANEL MOUNT PRIVACY DIVIDER CEILING FILLER KIT

- Privacy Felt Divider integrated with aluminum top trim.
- Aluminum top trim available in standard paint finishes.
- Attaches on top of panels to add privacy or divide space.
- Includes aluminum trim with channel and Felt tile.
- Felt tile and attachment hardware to ship separately.
- Felt material available in Graphite (GPH), Mist (MTS), Pewter (PWT), Harvest (HVT), Shamrock (SHR), Brick (BRI), Denim (DEN), Black (BLK) or White (WHT).
- PVC cap for closing gap at ceiling included.
- PVC cap available in white only.

DESCRIPTION	PRODUCT CODE	LIST PRICE	DIMENSIONS/INCHES		
			H	W	D
 Panel Mount Felt Divider Ceiling Filler Kit	EVFPDK0918PCF	110	9	18	
	EVFPDK0924PCF	131	9	24	
	EVFPDK0930PCF	156	9	30	
	EVFPDK0936PCF	183	9	36	
	EVFPDK0942PCF	206	9	42	
	EVFPDK0948PCF	304	9	48	
	EVFPDK0954PCF	329	9	54	
	EVFPDK0960PCF	358	9	60	
	EVFPDK0966PCF	376	9	66	
	EVFPDK0972PCF	424	9	72	



EVFPDK09XXPCFP - 9" H PANEL MOUNT PRIVACY DIVIDER CEILING FILLER KIT

- Privacy Felt Divider integrated with aluminum top trim.
- Aluminum trim is width of panel.
- Aluminum top trim available in standard paint finishes.
- Attaches on top of panels to add privacy or divide space.
- Includes aluminum trim with channel and Felt tile.
- Felt tile and attachment hardware to ship separately.
- Felt material available in Graphite (GPH), Mist (MTS), Pewter (PWT), Harvest (HVT), Shamrock (SHR), Brick (BRI), Denim (DEN), Black (BLK) or White (WHT).
- Felt tile is longer and overhangs half of width of post.
- PVC cap for closing gap at ceiling included.
- PVC cap available in white only.

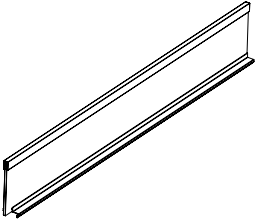
DESCRIPTION	PRODUCT CODE	LIST PRICE	DIMENSIONS/INCHES		
			H	W	D
 Panel Mount Felt Divider Ceiling Filler at Post Kit	EVFDK0919PCF	131	9	19 3/4	
	EVFDK0925PCF	156	9	25 3/4	
	EVFDK0931PCF	183	9	31 3/4	
	EVFDK0937PCF	206	9	37 3/4	
	EVFDK0943PCF	304	9	43 3/4	
	EVFDK0949PCF	329	9	49 3/4	
	EVFDK0955PCF	358	9	55 3/4	
	EVFDK0961PCF	376	9	61 3/4	
	EVFDK0967PCF	424	9	67 3/4	
	EVFDK0973PCF	475	9	73 3/4	

EVPTFC - CEILING FILLER PVC CAP FOR FELT DIVIDER

- To be installed on top on felt divider when used as ceiling filler.
- Field installed on top of felt divider to close gap at ceiling.
- Available in 18"-96" lengths.
- Available in white only.
- Felt divider with top trim kit to be ordered separately.

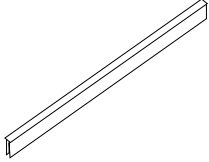
DESCRIPTION	PRODUCT CODE	LIST PRICE	DIMENSIONS/INCHES		
			H	W	D
 PVC Cap for Felt Divider	EVPTFC18	17	1 3/8	18	3/4
	EVPTFC24	19	1 3/8	24	3/4
	EVPTFC30	24	1 3/8	30	3/4
	EVPTFC36	27	1 3/8	36	3/4
	EVPTFC42	29	1 3/8	42	3/4
	EVPTFC48	43	1 3/8	48	3/4
	EVPTFC54	47	1 3/8	54	3/4
	EVPTFC60	49	1 3/8	60	3/4
	EVPTFC66	53	1 3/8	66	3/4
	EVPTFC72	58	1 3/8	72	3/4
	EVPTFC78	64	1 3/8	78	3/4
	EVPTFC84	69	1 3/8	84	3/4
	EVPTFC90	75	1 3/8	90	3/4
	EVPTFC96	81	1 3/8	96	3/4

EVFELTPXXHWR - ALUMINUM TOP TRIM WITH CHANNEL

- Top trim with channel.
- Available in standard paint colors.
- Note: Trim can span inline connector, but not a Post

DESCRIPTION	PRODUCT CODE	LIST PRICE	DIMENSIONS/INCHES		
			H	W	D
 Aluminum Top Trip	EVFELTP18HWR	43		18	2.875
	EVFELTP24HWR	44		24	2.875
	EVFELTP30HWR	51		30	2.875
	EVFELTP36HWR	57		36	2.875
	EVFELTP42HWR	64		42	2.875
	EVFELTP48HWR	70		48	2.875
	EVFELTP54HWR	76		54	2.875
	EVFELTP60HWR	84		60	2.875
	EVFELTP66HWR	92		66	2.875
	EVFELTP72HWR	104		72	2.875

EVFELTXXYP - FELT TILE

- Felt tile.
- Available in standard felt colors.
- Top trim with channel and PVC cap to be ordered separately.

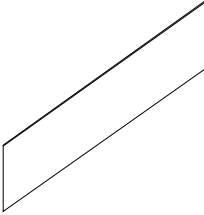
DESCRIPTION	PRODUCT CODE	LIST PRICE	DIMENSIONS/INCHES		
			H	W	D
 <p>Felt Tile - 6" High</p>	EVFELT0618P	31	6	18	
	EVFELT0624P	39	6	24	
	EVFELT0630P	54	6	30	
	EVFELT0636P	69	6	36	
	EVFELT0642P	85	6	42	
	EVFELT0648P	105	6	48	
	EVFELT0654P	119	6	54	
	EVFELT0660P	132	6	60	
	EVFELT0666P	149	6	66	
	EVFELT0672P	163	6	72	
<p>Felt Tile - 9" High</p>	EVFELT0918P	53	9	18	
	EVFELT0924P	64	9	24	
	EVFELT0930P	75	9	30	
	EVFELT0936P	91	9	36	
	EVFELT0942P	102	9	42	
	EVFELT0948P	169	9	48	
	EVFELT0954P	185	9	54	
	EVFELT0960P	202	9	60	
	EVFELT0966P	218	9	66	
	EVFELT0972P	231	9	72	



EVPP - GLAZED FREESTANDING PRIVACY PANEL

- Includes panel with two connectors with T legs.
- 3" thick freestanding panels with leveling glides.
- 22" deep T-legs for stability (9.5" on each side)
- All Modules are Tempered Glass.
- Includes end of run trim.

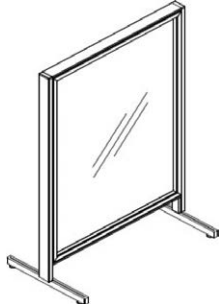
	DESCRIPTION	PRODUCT CODE	LIST PRICE		DIMENSIONS/INCHES		
			CLR	FRST	H	W	D
	Glazed Monolithic Freestanding Privacy Panel	EVPPXGT5418	833	1014	54	18	27/8
		EVPPXGT5424	919	1132	54	24	27/8
		EVPPXGT5430	999	1246	54	30	27/8
		EVPPXGT5436	1075	1354	54	36	27/8
		EVPPXGT5442	1161	1475	54	42	27/8

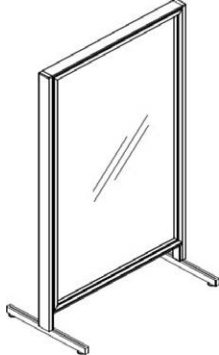
	DESCRIPTION	PRODUCT CODE	LIST PRICE		DIMENSIONS/INCHES		
			CLR	FRST	H	W	D
	Glazed Monolithic Freestanding Privacy Panel	EVPPXGT6618	960	1178	66	18	27/8
		EVPPXGT6624	1054	1309	66	24	27/8
		EVPPXGT6630	1150	1441	66	30	27/8
		EVPPXGT6636	1237	1564	66	36	27/8
		EVPPXGT6642	1340	1709	66	42	27/8

EVPP - GLAZED MOBILE PRIVACY PANEL

- Includes panel with two connectors with T legs.
- 3" thick freestanding panels with 1" locking casters.
- 22" deep T-legs for stability (9.5" on each side)
- All Modules are Tempered Glass.
- Includes end of run trim.

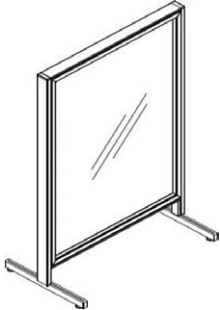
DESCRIPTION	PRODUCT CODE	LIST PRICE			DIMENSIONS/INCHES		
		CLR	FRST	WRW	H	W	D
 Mobile Glazed Monolithic Privacy Panel	EVPPXGT5418M	905	1086	1513	54	18	2 7/8
	EVPPXGT5424M	988	1204	1741	54	24	2 7/8
	EVPPXGT5430M	1069	1316	1963	54	30	2 7/8
	EVPPXGT5436M	1146	1425	2184	54	36	2 7/8
	EVPPXGT5442M	1232	1545	2415	54	42	2 7/8

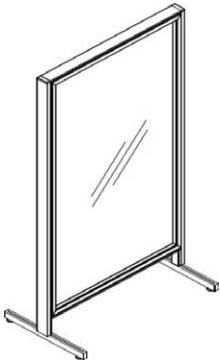
DESCRIPTION	PRODUCT CODE	LIST PRICE			DIMENSIONS/INCHES		
		CLR	FRST	WRW	H	W	D
 Mobile Glazed Monolithic Privacy Panel	EVPPXGT6618M	1029	1247	1777	66	18	2 7/8
	EVPPXGT6624M	1124	1379	2047	66	24	2 7/8
	EVPPXGT6630M	1219	1511	2316	66	30	2 7/8
	EVPPXGT6636M	1307	1635	2576	66	36	2 7/8
	EVPPXGT6642M	1410	1779	2859	66	42	2 7/8



EVPP - MONOLITHIC PRIVACY PANEL - RIBBED POLYCARBONATE

- Includes panel with two connectors with T legs.
- 3" thick freestanding panels with leveling glides
- 22" deep T-legs for stability (9.5" on each side)
- Ribbed Panels are semi-private translucent polycarbonate.
- Includes end of run trim.

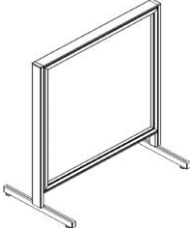
DESCRIPTION	PRODUCT CODE	LIST PRICE	DIMENSIONS/INCHES		
			H	W	D
 Freestanding Ribbed Monolithic Privacy Panel	EVPPXGR4218	761	42	18	2 7/8
	EVPPXGR4224	797	42	24	2 7/8
	EVPPXGR4230	868	42	30	2 7/8
	EVPPXGR4236	939	42	36	2 7/8
	EVPPXGR4242	1012	42	42	2 7/8

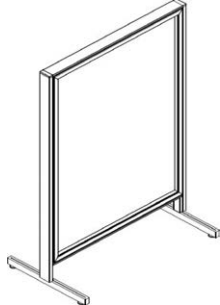
DESCRIPTION	PRODUCT CODE	LIST PRICE	DIMENSIONS/INCHES		
			H	W	D
 Freestanding Ribbed Monolithic Privacy Panel	EVPPXGR5418	891	54	18	2 7/8
	EVPPXGR5424	946	54	24	2 7/8
	EVPPXGR5430	1028	54	30	2 7/8
	EVPPXGR5436	1111	54	36	2 7/8
	EVPPXGR5442	1201	54	42	2 7/8

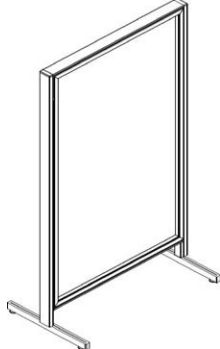
DESCRIPTION	PRODUCT CODE	LIST PRICE	DIMENSIONS/INCHES		
			H	W	D
 Freestanding Ribbed Monolithic Privacy Panel	EVPPXGR6618	976	66	18	2 7/8
	EVPPXGR6624	1078	66	24	2 7/8
	EVPPXGR6630	1173	66	30	2 7/8
	EVPPXGR6636	1267	66	36	2 7/8
	EVPPXGR6642	1369	66	42	2 7/8

EVPP - MONOLITHIC PRIVACY PANEL - RIBBED POLYCARBONATE

- Includes panel with two connectors with T legs.
- 3" thick freestanding panels with 1" locking casters.
- 22" deep T-legs for stability (9.5" on each side)
- Ribbed Panels are semi-private translucent polycarbonate.
- Includes end of run trim.

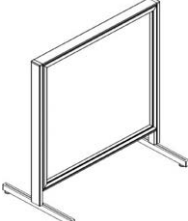
	DESCRIPTION	PRODUCT CODE	LIST PRICE	DIMENSIONS/INCHES		
				H	W	D
	Mobile Ribbed Monolithic Privacy Panel	EVPPXGR4218M	830	42	18	2 7/8
		EVPPXGR4224M	868	42	24	2 7/8
		EVPPXGR4230M	939	42	30	2 7/8
		EVPPXGR4236M	1009	42	36	2 7/8
		EVPPXGR4242M	1082	42	42	2 7/8

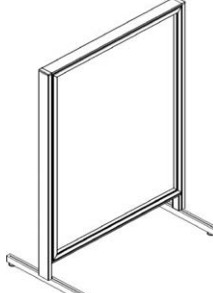
	DESCRIPTION	PRODUCT CODE	LIST PRICE	DIMENSIONS/INCHES		
				H	W	D
	Mobile Ribbed Monolithic Privacy Panel	EVPPXGR5418M	965	54	18	2 7/8
		EVPPXGR5424M	1017	54	24	2 7/8
		EVPPXGR5430M	1100	54	30	2 7/8
		EVPPXGR5436M	1182	54	36	2 7/8
		EVPPXGR5442M	1272	54	42	2 7/8

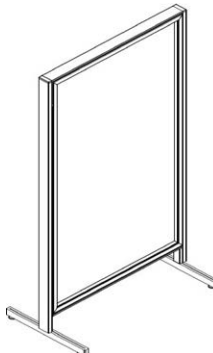
	DESCRIPTION	PRODUCT CODE	LIST PRICE	DIMENSIONS/INCHES		
				H	W	D
	Mobile Ribbed Monolithic Privacy Panel	EVPPXGR6618M	1047	66	18	2 7/8
		EVPPXGR6624M	1150	66	24	2 7/8
		EVPPXGR6630M	1173	66	30	2 7/8
		EVPPXGR6636M	1337	66	36	2 7/8
		EVPPXGR6642M	1438	66	42	2 7/8



EVPP - MONOLITHIC PRIVACY PANEL - GLAZED

- Includes panel with two connectors with T legs
- 3" thick freestanding panels with flat foot
- 22" deep T-legs for stability (9.5" on each side)
- Glazed Panels are available in tempered Clear glass (CLR) and Frosted glass (FRST)
- Includes end of run trim

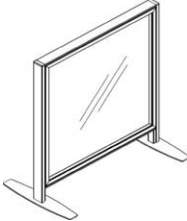
DESCRIPTION	PRODUCT CODE	LIST PRICE		DIMENSIONS/INCHES		
		CLR	FRST	H	W	D
 Freestanding Glazed Monolithic Privacy Panel	EVPPXGTF4218	715	863	42	18	27/8
	EVPPXGTF4224	787	966	42	24	27/8
	EVPPXGTF4230	855	1058	42	30	27/8
	EVPPXGTF4236	920	1133	42	36	27/8
	EVPPXGTF4242	994	1254	42	42	27/8

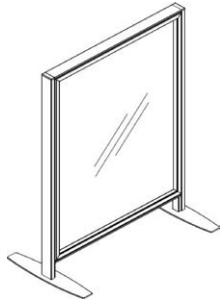
DESCRIPTION	PRODUCT CODE	LIST PRICE		DIMENSIONS/INCHES		
		CLR	FRST	H	W	D
 Freestanding Glazed Monolithic Privacy Panel	EVPPXGTF5418	833	1014	54	18	27/8
	EVPPXGTF5424	919	1132	54	24	27/8
	EVPPXGTF5430	999	1246	54	30	27/8
	EVPPXGTF5436	1075	1354	54	36	27/8
	EVPPXGTF5442	1161	1440	54	42	27/8

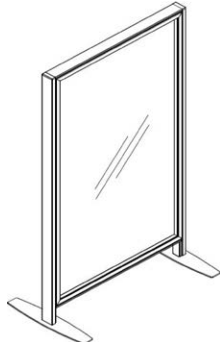
DESCRIPTION	PRODUCT CODE	LIST PRICE		DIMENSIONS/INCHES		
		CLR	FRST	H	W	D
 Freestanding Glazed Monolithic Privacy Panel	EVPPXGTF6618	960	1178	66	18	27/8
	EVPPXGTF6624	1054	1309	66	24	27/8
	EVPPXGTF6630	1150	1441	66	30	27/8
	EVPPXGTF6636	1237	1564	66	36	27/8
	EVPPXGTF6642	1340	1708	66	42	27/8

EVPP - MONOLITHIC PRIVACY PANEL - RIBBED POLYCARBONATE

- Includes panel with two connectors with T legs
- 3" thick freestanding panels with flat foot
- 22" deep T-legs for stability (9.5" on each side)
- Ribbed Panels are semi-private translucent polycarbonate.
- Includes end of run trim.

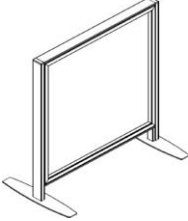
	DESCRIPTION	PRODUCT CODE	LIST PRICE	DIMENSIONS/INCHES		
				H	W	D
	Freestanding Ribbed Monolithic Privacy Panel	EVPPXGRF4218	761	42	18	2 7/8
		EVPPXGRF4224	797	42	24	2 7/8
		EVPPXGRF4230	868	42	30	2 7/8
		EVPPXGRF4236	939	42	36	2 7/8
		EVPPXGRF4242	1012	42	42	2 7/8

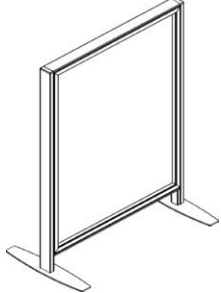
	DESCRIPTION	PRODUCT CODE	LIST PRICE	DIMENSIONS/INCHES		
				H	W	D
	Freestanding Ribbed Monolithic Privacy Panel	EVPPXGRF5418	891	54	18	2 7/8
		EVPPXGRF5424	946	54	24	2 7/8
		EVPPXGRF5430	1028	54	30	2 7/8
		EVPPXGRF5436	1111	54	36	2 7/8
		EVPPXGRF5442	1201	54	42	2 7/8

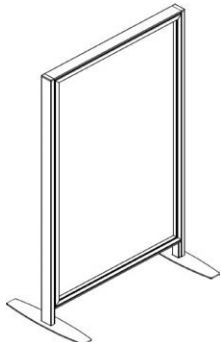
	DESCRIPTION	PRODUCT CODE	LIST PRICE	DIMENSIONS/INCHES		
				H	W	D
	Freestanding Ribbed Monolithic Privacy Panel	EVPPXGRF6618	976	66	18	2 7/8
		EVPPXGRF6624	1078	66	24	2 7/8
		EVPPXGRF6630	1173	66	30	2 7/8
		EVPPXGRF6636	1267	66	36	2 7/8
		EVPPXGRF6642	1369	66	42	2 7/8



EVPP - MONOLITHIC PRIVACY PANEL - 78" HIGH

- Includes panel with two connectors with T legs.
- 3" thick freestanding panels with leveling glides
- 22" deep T-legs for stability (9.5" on each side)
- Glazed Panels are available in tempered Clear glass (CLR) and Frosted glass (FRST)
- Ribbed Panels are semi-private translucent polycarbonate.
- Includes end of run trim.
- Includes 48"H Glazed module and 29"H legs

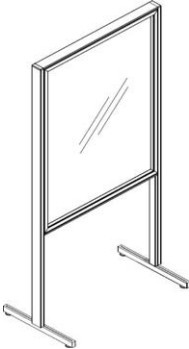
	DESCRIPTION	PRODUCT CODE	LIST PRICE		DIMENSIONS/INCHES		
			CLR	FRST	H	W	D
	Freestanding Glazed Monolithic Privacy Panel	EVPPXGT7824	984	1200	78	24	2 7/8
		EVPPXGT7830	1063	1310	78	30	2 7/8
		EVPPXGT7836	1142	1421	78	36	2 7/8
		EVPPXGT7842	1229	1542	78	42	2 7/8

EVPP - MONOLITHIC PRIVACY PANEL - 78" HIGH

- Includes panel with two connectors with T legs.
- 3" thick freestanding panels with leveling glides
- 22" deep T-legs for stability (9.5" on each side)
- Glazed Panels are available in tempered Clear glass (CLR) and Frosted glass (FRST)
- Ribbed Panels are semi-private translucent polycarbonate.
- Includes end of run trim.
- Includes 48"H Ribbled module and 29"H legs

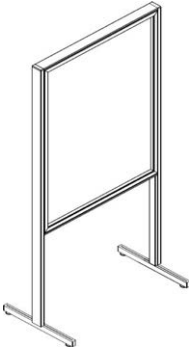
	DESCRIPTION	PRODUCT CODE	LIST PRICE	DIMENSIONS/INCHES		
				H	W	D
	Freestanding Ribbed Monolithic Privacy Panel	EVPPXGR7824	1020	78	24	2 7/8
		EVPPXGR7830	1104	78	30	2 7/8
		EVPPXGR7836	1020	78	36	2 7/8
		EVPPXGR7842	1276	78	42	2 7/8

EVPP - MONOLITHIC PRIVACY PANEL - 78" HIGH

- Includes panel with two connectors with T legs.
- 3" thick freestanding panels with 1" locking casters
- 22" deep T-legs for stability (9.5" on each side)
- Glazed Panels are available in tempered Clear glass (CLR) and Frosted glass (FRST)
- Ribbed Panels are semi-private translucent polycarbonate.
- Includes end of run trim.
- Includes 48"H Glazed module and 29"H legs

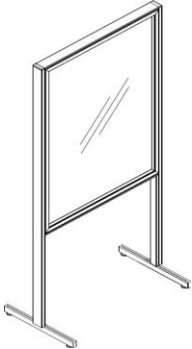
	DESCRIPTION	PRODUCT CODE	LIST PRICE		DIMENSIONS/INCHES		
			CLR	FRST	H	W	D
	Mobile Glazed Monolithic Privacy Panel	EVPPXGT7824M	1055	1268	78	24	2 7/8
		EVPPXGT7830M	1136	1383	78	30	2 7/8
		EVPPXGT7836M	1213	1492	78	36	2 7/8
		EVPPXGT7842M	1297	1611	78	42	2 7/8

EVPP - MONOLITHIC PRIVACY PANEL - 78" HIGH

- Includes panel with two connectors with T legs.
- 3" thick freestanding panels with 1" locking casters
- 22" deep T-legs for stability (9.5" on each side)
- Glazed Panels are available in tempered Clear glass (CLR) and Frosted glass (FRST)
- Ribbed Panels are semi-private translucent polycarbonate.
- Includes end of run trim.
- Includes 48"H Ribbed module and 29"H legs

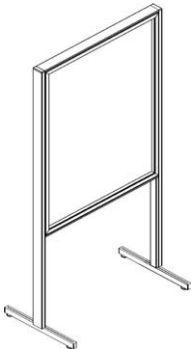
	DESCRIPTION	PRODUCT CODE	LIST PRICE	DIMENSIONS/INCHES		
				H	W	D
	Mobile Ribbed Monolithic Privacy Panel	EVPPXGR7824M	1092	78	24	2 7/8
		EVPPXGR7830M	1174	78	30	2 7/8
		EVPPXGR7836M	1092	78	36	2 7/8
		EVPPXGR7842M	1347	78	42	2 7/8



EVPP - MONOLITHIC PRIVACY PANEL - 78" HIGH

- Includes panel with two connectors with T legs
- 3" thick freestanding panels with flat foot
- 22" deep T-legs for stability (9.5" on each side)
- Glazed Panels are available in tempered Clear glass (CLR) and Frosted glass (FRST)
- Ribbed Panels are semi-private translucent polycarbonate.
- Includes end of run trim.
- Includes 48"H Glazed module and 29"H legs

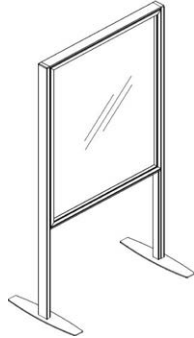

DESCRIPTION	PRODUCT CODE	LIST PRICE		DIMENSIONS/INCHES		
		CLR	FRST	H	W	D
Freestanding Glazed Monolithic Privacy Panel	EVPPXGTF7824	984	1200	78	24	2 7/8
	EVPPXGTF7830	1063	1310	78	30	2 7/8
	EVPPXGTF7836	1142	1421	78	36	2 7/8
	EVPPXGTF7842	1229	1542	78	42	2 7/8

EVPP - MONOLITHIC PRIVACY PANEL - 78" HIGH

- Includes panel with two connectors with T legs
- 3" thick freestanding panels with flat foot
- 22" deep T-legs for stability (9.5" on each side)
- Glazed Panels are available in tempered Clear glass (CLR) and Frosted glass (FRST)
- Ribbed Panels are semi-private translucent polycarbonate.
- Includes end of run trim.
- Includes 48"H Ribbed module and 29"H legs

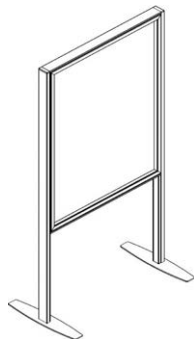

DESCRIPTION	PRODUCT CODE	LIST PRICE	DIMENSIONS/INCHES		
			H	W	D
Freestanding Ribbed Monolithic Privacy Panel	EVPPXGRF7824	1020	78	24	2 7/8
	EVPPXGRF7830	1104	78	30	2 7/8
	EVPPXGRF7836	1020	78	36	2 7/8
	EVPPXGRF7842	1276	78	42	2 7/8

EVPP - GLAZED PRIVACY PANEL

- Includes panel with two connectors with T legs.
- 3" thick freestanding panels with leveling glides
- 22" deep T-legs for stability (9.5" on each side)
- All Modules are Tempered Glass.
- Available in clear glass (CLR) and frosted glass (FRST)
- Includes end of run trim.

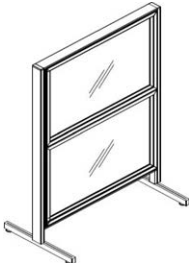
DESCRIPTION	PRODUCT CODE	LIST PRICE		DIMENSIONS/INCHES		
		CLR	FRST	H	W	D
 Freestanding Glazed Privacy Panel	EVPPGT5424	949	1177	54	24	27/8
	EVPPGT5430	1042	1309	54	30	27/8
	EVPPGT5436	1135	1438	54	36	27/8
	EVPPGT5442	1234	1577	54	42	27/8
	EVPPGT5448	1331	1714	54	48	27/8
	EVPPGT5454	1435	1860	54	54	27/8
	EVPPGT5460	1525	1985	54	60	27/8

EVPP - GLAZED PRIVACY PANEL

- Includes panel with two connectors with T legs.
- 3" thick freestanding panels with leveling glides
- 22" deep T-legs for stability (9.5" on each side)
- All Modules are Tempered Glass.
- Available in clear glass (CLR) and frosted glass (FRST)
- Includes end of run trim.

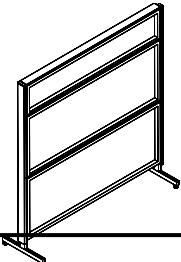
DESCRIPTION	PRODUCT CODE	LIST PRICE		DIMENSIONS/INCHES		
		CLR	FRST	H	W	D
 Freestanding Glazed Privacy Panel	EVPPGT6624	1185	1493	66	24	27/8
	EVPPGT6630	1300	1658	66	30	27/8
	EVPPGT6636	1481	1907	66	36	27/8
	EVPPGT6642	1606	2083	66	42	27/8
	EVPPGT6648	1733	2264	66	48	27/8
	EVPPGT6654	1875	2462	66	54	27/8
	EVPPGT6660	2030	2675	66	60	27/8

EVPP - MOBILE GLAZED PRIVACY PANEL

- Includes panel with two connectors with T legs.
- 3" thick freestanding panels with 1" locking casters.
- 22" deep T-legs for stability (9.5" on each side)
- All Modules are Tempered Glass.
- Available in clear glass (CLR) and frosted glass (FRST)
- Includes end of run trim.

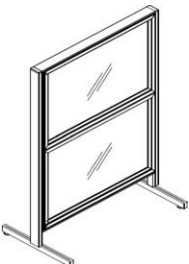
DESCRIPTION	PRODUCT CODE	LIST PRICE		DIMENSIONS/INCHES		
		CLR	FRST	H	W	D
 Mobile Glazed Privacy Panel	EVPPGT5424M	1019	1248	54	24	27/8
	EVPPGT5430M	1113	1381	54	30	27/8
	EVPPGT5436M	1204	1507	54	36	27/8
	EVPPGT5442M	1304	1647	54	42	27/8
	EVPPGT5448M	1402	1785	54	48	27/8
	EVPPGT5454M	1505	1930	54	54	27/8
	EVPPGT5460M	1595	2055	54	60	27/8



EVPP - MOBILE GLAZED PRIVACY PANEL

- Includes panel with two connectors with T legs.
- 3" thick freestanding panels with 1" locking casters.
- 22" deep T-legs for stability (9.5" on each side)
- All Modules are Tempered Glass.
- Available in clear glass (CLR) and frosted glass (FRST)
- Includes end of run trim.

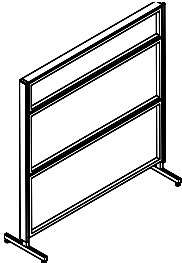
	DESCRIPTION	PRODUCT CODE	LIST PRICE		DIMENSIONS/INCHES		
			CLR	FRST	H	W	D
	Mobile Glazed Privacy Panel	EVPPGT6624M	1256	1566	66	24	2 7/8
		EVPPGT6630M	1371	1727	66	30	2 7/8
		EVPPGT6636M	1550	1976	66	36	2 7/8
		EVPPGT6642M	1677	2154	66	42	2 7/8
		EVPPGT6648M	1803	2334	66	48	2 7/8
		EVPPGT6654M	1946	2529	66	54	2 7/8
		EVPPGT6660M	2098	2744	66	60	2 7/8

EVPP - LAMINATE GLAZED PRIVACY PANEL

- Includes panel with two connectors with T legs.
- 3" thick freestanding panels with leveling glides
- 22" deep T-legs for stability (9.5" on each side)
- All Modules are Tempered Glass.
- Bottom Two Modules are Laminate w/12" Tempered Glass on top.
- Includes end of run trim.

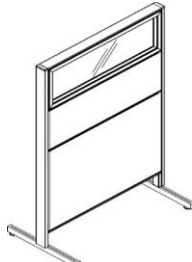
	DESCRIPTION	PRODUCT CODE	LIST PRICE		DIMENSIONS/INCHES		
			CLR	FRST	H	W	D
	Freestanding Laminate Glazed Privacy Panel	EVPPHGTU5424	1158	1316	54	24	2 7/8
		EVPPHGTU5430	1285	1468	54	30	2 7/8
		EVPPHGTU5436	1414	1625	54	36	2 7/8
		EVPPHGTU5442	1542	1778	54	42	2 7/8
		EVPPHGTU5448	1670	1930	54	48	2 7/8
		EVPPHGTU5454	1811	2100	54	54	2 7/8
		EVPPHGTU5460	1941	2255	54	60	2 7/8

EVPP - LAMINATE GLAZED PRIVACY PANEL

- Includes panel with two connectors with T legs.
- 3" thick freestanding panels with leveling glides
- 22" deep T-legs for stability (9.5" on each side)
- Bottom Two Modules are Laminate w/12" Tempered Glass on top.
- Includes end of run trim.

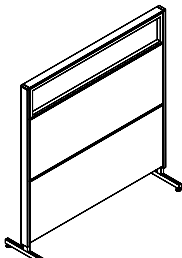
	DESCRIPTION	PRODUCT CODE	LIST PRICE		DIMENSIONS/INCHES		
			CLR	FRST	H	W	D
	Freestanding Laminate Glazed Privacy Panel	EVPPHGTU6624	1295	1475	66	24	2 7/8
		EVPPHGTU6630	1446	1655	66	30	2 7/8
		EVPPHGTU6636	1626	1872	66	36	2 7/8
		EVPPHGTU6642	1774	2046	66	42	2 7/8
		EVPPHGTU6648	1920	2224	66	48	2 7/8
		EVPPHGTU6654	2088	2425	66	54	2 7/8
		EVPPHGTU6660	2271	2643	66	60	2 7/8

EVPP - MOBILE LAMINATE GLAZED PRIVACY PANEL

- Includes panel with two connectors with T legs.
- 3" thick freestanding panels with 1" locking casters.
- 22" deep T-legs for stability (9.5" on each side)
- Bottom Two Modules are Laminate w/12" Tempered Glass on top.
- Includes end of run trim.

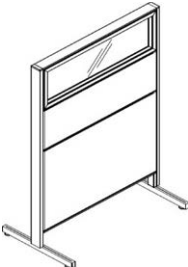
DESCRIPTION	PRODUCT CODE	LIST PRICE		DIMENSIONS/INCHES		
		CLR	FRST	H	W	D
 <p>Mobile Laminate Glazed Privacy Panel</p>	EVPPHGTU5424M	1229	1387	54	24	2 7/8
	EVPPHGTU5430M	1355	1538	54	30	2 7/8
	EVPPHGTU5436M	1485	1694	54	36	2 7/8
	EVPPHGTU5442M	1615	1851	54	42	2 7/8
	EVPPHGTU5448M	1741	2002	54	48	2 7/8
	EVPPHGTU5454M	1880	2170	54	54	2 7/8
	EVPPHGTU5460M	2011	2326	54	60	2 7/8

EVPP - MOBILE LAMINATE GLAZED PRIVACY PANEL

- Includes panel with two connectors with T legs.
- 3" thick freestanding panels with 1" locking casters.
- 22" deep T-legs for stability (9.5" on each side)
- Bottom Two Modules are Laminate w/12" Tempered Glass on top.
- Includes end of run trim.

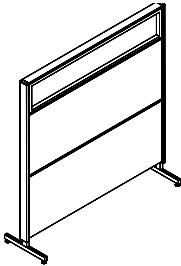
DESCRIPTION	PRODUCT CODE	LIST PRICE		DIMENSIONS/INCHES		
		CLR	FRST	H	W	D
 <p>Mobile Laminate Glazed Privacy Panel</p>	EVPPHGTU6624M	1366	1546	66	24	2 7/8
	EVPPHGTU6630M	1516	1723	66	30	2 7/8
	EVPPHGTU6636M	1697	1944	66	36	2 7/8
	EVPPHGTU6642M	1844	2115	66	42	2 7/8
	EVPPHGTU6648M	1993	2296	66	48	2 7/8
	EVPPHGTU6654M	2158	2495	66	54	2 7/8
	EVPPHGTU6660M	2341	2713	66	60	2 7/8

EVPP - LAMINATE GLAZED PRIVACY PANEL

- Includes panel with two connectors with T legs.
- 3" thick freestanding panels with leveling glides
- 22" deep T-legs for stability (9.5" on each side)
- All Modules are Tempered Glass.
- Laminate Base Module w/24" Tempered Glass above.
- Includes end of run trim.

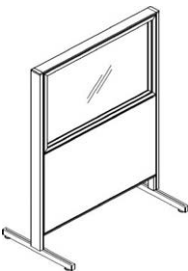
DESCRIPTION	PRODUCT CODE	LIST PRICE		DIMENSIONS/INCHES		
		CLR	FRST	H	W	D
 <p>Freestanding Laminate Glazed Privacy Panel</p>	EVPPHGT5424	1003	1130	54	24	2 7/8
	EVPPHGT5430	1114	1264	54	30	2 7/8
	EVPPHGT5436	1229	1399	54	36	2 7/8
	EVPPHGT5442	1341	1534	54	42	2 7/8
	EVPPHGT5448	1450	1668	54	48	2 7/8
	EVPPHGT5454	1570	1810	54	54	2 7/8
	EVPPHGT5460	1676	1938	54	60	2 7/8



EVPP - LAMINATE GLAZED PRIVACY PANEL

- Includes panel with two connectors with T legs.
- 3" thick freestanding panels with leveling glides
- 22" deep T-legs for stability (9.5" on each side)
- Laminate Base Module w/36" Tempered Glass above.
- Includes end of run trim.

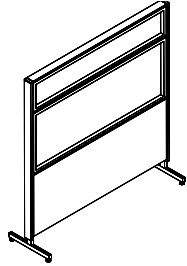

DESCRIPTION	PRODUCT CODE	LIST PRICE		DIMENSIONS/INCHES		
		CLR	FRST	H	W	D
Freestanding Laminate Glazed Privacy Panel	EVPPHGT6624	1241	1408	66	24	2 7/8
	EVPPHGT6630	1374	1567	66	30	2 7/8
	EVPPHGT6636	1547	1776	66	36	2 7/8
	EVPPHGT6642	1678	1933	66	42	2 7/8
	EVPPHGT6648	1814	2096	66	48	2 7/8
	EVPPHGT6654	1969	2283	66	54	2 7/8
	EVPPHGT6660	2149	2497	66	60	2 7/8

EVPP - MOBILE LAMINATE GLAZED PRIVACY PANEL

- Includes panel with two connectors with T legs.
- 3" thick freestanding panels with 1" locking casters.
- 22" deep T-legs for stability (9.5" on each side)
- Laminate Base Module w/36" Tempered Glass above.
- Includes end of run trim.

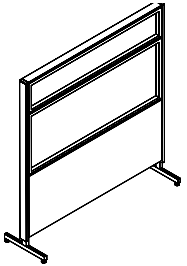

DESCRIPTION	PRODUCT CODE	LIST PRICE		DIMENSIONS/INCHES		
		CLR	FRST	H	W	D
Mobile Laminate Glazed Privacy Panel	EVPPHGT6624M	1312	1480	66	24	2 7/8
	EVPPHGT6630M	1445	1637	66	30	2 7/8
	EVPPHGT6636M	1619	1848	66	36	2 7/8
	EVPPHGT6642M	1748	2003	66	42	2 7/8
	EVPPHGT6648M	1885	2166	66	48	2 7/8
	EVPPHGT6654M	2040	2353	66	54	2 7/8
	EVPPHGT6660M	2220	2568	66	60	2 7/8

EVPP - MOBILE LAMINATE GLAZED PRIVACY PANEL

- Includes panel with two connectors with T legs.
- 3" thick freestanding panels with 1" locking casters.
- 22" deep T-legs for stability (9.5" on each side)
- Laminate Base Module w/24" Tempered Glass above.
- Includes end of run trim.

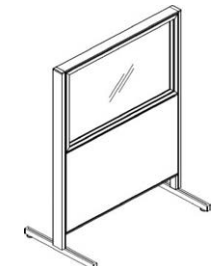

DESCRIPTION	PRODUCT CODE	LIST PRICE		DIMENSIONS/INCHES		
		CLR	FRST	H	W	D
Mobile Laminate Glazed Privacy Panel	EVPPHGT5424M	1073	1201	54	24	2 7/8
	EVPPHGT5430M	1184	1334	54	30	2 7/8
	EVPPHGT5436M	1297	1468	54	36	2 7/8
	EVPPHGT5442M	1412	1608	54	42	2 7/8
	EVPPHGT5448M	1523	1740	54	48	2 7/8
	EVPPHGT5454M	1641	1881	54	54	2 7/8
	EVPPHGT5460M	1746	2007	54	60	2 7/8

EVPP - LAMINATE PRIVACY PANEL

- Includes panel with two connectors with T legs.
- 3" thick freestanding panels with leveling glides
- 22" deep T-legs for stability (9.5" on each side)
- All Modules are Laminate.
- Includes end of run trim.

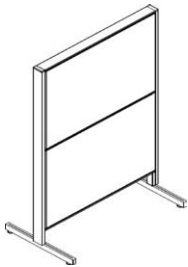
DESCRIPTION	PRODUCT CODE	LIST PRICE	DIMENSIONS/INCHES		
			H	W	D
 Freestanding Laminate Privacy Panel	EVPPH2S5424	1058	54	24	2 7/8
	EVPPH2S5430	1187	54	30	2 7/8
	EVPPH2S5436	1324	54	36	2 7/8
	EVPPH2S5442	1448	54	42	2 7/8
	EVPPH2S5448	1570	54	48	2 7/8
	EVPPH2S5454	1705	54	54	2 7/8
	EVPPH2S5460	1826	54	60	2 7/8

EVPP - LAMINATE PRIVACY PANEL

- Includes panel with two connectors with T legs.
- 3" thick freestanding panels with leveling glides
- 22" deep T-legs for stability (9.5" on each side)
- All Modules are Laminate.
- Includes end of run trim.

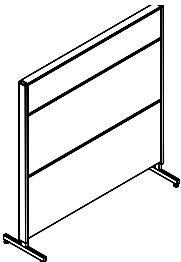
DESCRIPTION	PRODUCT CODE	LIST PRICE	DIMENSIONS/INCHES		
			H	W	D
 Freestanding Laminate Privacy Panel	EVPPH2S6624	1281	66	24	2 7/8
	EVPPH2S6630	1447	66	30	2 7/8
	EVPPH2S6636	1637	66	36	2 7/8
	EVPPH2S6642	1801	66	42	2 7/8
	EVPPH2S6648	1960	66	48	2 7/8
	EVPPH2S6654	2126	66	54	2 7/8
	EVPPH2S6660	2301	66	60	2 7/8

EVPP - MOBILE LAMINATE PRIVACY PANEL

- Includes panel with two connectors with T legs.
- 3" thick freestanding panels with 1" locking casters.
- 22" deep T-legs for stability (9.5" on each side)
- All Modules are Laminate.
- Available in clear glass (CLR) and frosted glass (FRST)
- Includes end of run trim.

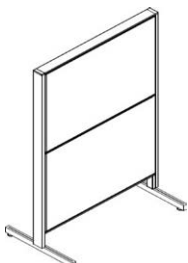
DESCRIPTION	PRODUCT CODE	LIST PRICE	DIMENSIONS/INCHES		
			H	W	D
 Mobile Laminate Privacy Panel	EVPPH2S5424M	1127	54	24	2 7/8
	EVPPH2S5430M	1257	54	30	2 7/8
	EVPPH2S5436M	1393	54	36	2 7/8
	EVPPH2S5442M	1520	54	42	2 7/8
	EVPPH2S5448M	1641	54	48	2 7/8
	EVPPH2S5454M	1775	54	54	2 7/8
	EVPPH2S5460M	1898	54	60	2 7/8



EVPP - MOBILE LAMINATE PRIVACY PANEL

- Includes panel with two connectors with T legs.
- 3" thick freestanding panels with 1" locking casters.
- 22" deep T-legs for stability (9.5" on each side)
- All Modules are Laminate.
- Includes end of run trim.

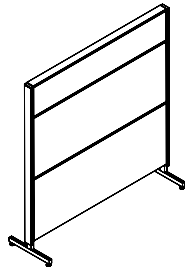

DESCRIPTION	PRODUCT CODE	LIST PRICE	DIMENSIONS/INCHES		
			H	W	D
Mobile Laminate Privacy Panel	EVPPH2S6624M	1351	66	24	2 7/8
	EVPPH2S6630M	1518	66	30	2 7/8
	EVPPH2S6636M	1708	66	36	2 7/8
	EVPPH2S6642M	1872	66	42	2 7/8
	EVPPH2S6648M	2031	66	48	2 7/8
	EVPPH2S6654M	2196	66	54	2 7/8
	EVPPH2S6660M	2371	66	60	2 7/8

EVPP - FABRIC WRITE BOARD PRIVACY PANEL

- Includes panel with two connectors with T legs.
- 3" thick freestanding panels with leveling glides
- 22" deep T-legs for stability (9.5" on each side)
- Fabric Base Module with Write Board above.
- Includes end of run trim.

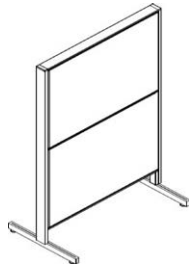

DESCRIPTION	PRODUCT CODE	LIST PRICE		DIMENSIONS/INCHES		
		GR 1	GR 2	H	W	D
Freestanding Write Board Privacy Panel	EVPPF2W5424	1021	1040	54	24	2 7/8
	EVPPF2W5430	1143	1164	54	30	2 7/8
	EVPPF2W5436	1265	1295	54	36	2 7/8
	EVPPF2W5442	1388	1418	54	42	2 7/8
	EVPPF2W5448	1527	1564	54	48	2 7/8
	EVPPF2W5454	1659	1699	54	54	2 7/8
	EVPPF2W5460	1777	1823	54	60	2 7/8

EVPP - MOBILE FABRIC WRITE BOARD PRIVACY PANEL

- Includes panel with two connectors with T legs.
- 3" thick freestanding panels with 1" locking casters.
- 22" deep T-legs for stability (9.5" on each side)
- Fabric Base Module with Write Board above.
- Includes end of run trim.

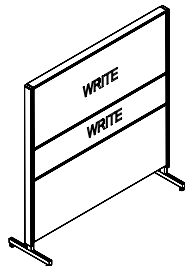

DESCRIPTION	PRODUCT CODE	LIST PRICE		DIMENSIONS/INCHES		
		GR 1	GR 2	H	W	D
Mobile Write Board Glazed Privacy Panel	EVPPF2W6624M	1304	1324	66	24	2 7/8
	EVPPF2W6630M	1516	1539	66	30	2 7/8
	EVPPF2W6636M	1701	1726	66	36	2 7/8
	EVPPF2W6642M	1869	1901	66	42	2 7/8
	EVPPF2W6648M	2054	2088	66	48	2 7/8
	EVPPF2W6654M	2226	2273	66	54	2 7/8
	EVPPF2W6660M	2440	2481	66	60	2 7/8

EVPP - MOBILE FABRIC WRITE BOARD PRIVACY PANEL

- Includes panel with two connectors with T legs.
- 3" thick freestanding panels with 1" locking casters.
- 22" deep T-legs for stability (9.5" on each side)
- Fabric Base Module with Write Board above.
- Includes end of run trim.

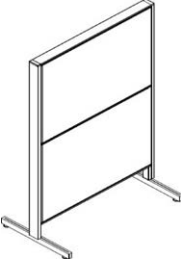
DESCRIPTION	PRODUCT CODE	LIST PRICE		DIMENSIONS/INCHES		
		GR 1	GR 2	H	W	D
 <p>Mobile Write Board Privacy Panel</p>	EVPPF2W5424M	1093	1110	54	24	2 7/8
	EVPPF2W5430M	1214	1237	54	30	2 7/8
	EVPPF2W5436M	1336	1366	54	36	2 7/8
	EVPPF2W5442M	1457	1489	54	42	2 7/8
	EVPPF2W5448M	1598	1632	54	48	2 7/8
	EVPPF2W5454M	1729	1768	54	54	2 7/8
	EVPPF2W5460M	1848	1895	54	60	2 7/8

EVPP - MOBILE LAMINATE WRITE BOARD PRIVACY PANEL

- Includes panel with two connectors with T legs.
- 3" thick freestanding panels with 1" locking casters.
- 22" deep T-legs for stability (9.5" on each side)
- Laminate Base Module with Write Board above.
- Includes end of run trim.

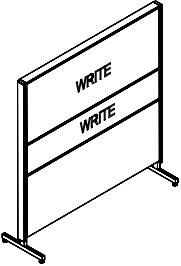
DESCRIPTION	PRODUCT CODE	LIST PRICE	DIMENSIONS/INCHES		
			H	W	D
 <p>Mobile Write Board Laminate Privacy Panel</p>	EVPPH2W6624M	1395	66	24	2 7/8
	EVPPH2W6630M	1639	66	30	2 7/8
	EVPPH2W6636M	1862	66	36	2 7/8
	EVPPH2W6642M	2044	66	42	2 7/8
	EVPPH2W6648M	2228	66	48	2 7/8
	EVPPH2W6654M	2420	66	54	2 7/8
	EVPPH2W6660M	2615	66	60	2 7/8

EVPP - LAMINATE WRITE BOARD PRIVACY PANEL

- Includes panel with two connectors with T legs.
- 3" thick freestanding panels with leveling glides
- 22" deep T-legs for stability (9.5" on each side)
- Laminate Base Module with Write Board above.
- Includes end of run trim.

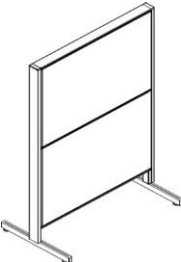
DESCRIPTION	PRODUCT CODE	LIST PRICE	DIMENSIONS/INCHES		
			H	W	D
 <p>Freestanding Write Board Privacy Panel</p>	EVPPH2W5424	1121	54	24	2 7/8
	EVPPH2W5430	1268	54	30	2 7/8
	EVPPH2W5436	1422	54	36	2 7/8
	EVPPH2W5442	1564	54	42	2 7/8
	EVPPH2W5448	1701	54	48	2 7/8
	EVPPH2W5454	1852	54	54	2 7/8
	EVPPH2W5460	1989	54	60	2 7/8



EVPP - LAMINATE WRITE BOARD PRIVACY PANEL

- Includes panel with two connectors with T legs.
- 3" thick freestanding panels with leveling glides
- 22" deep T-legs for stability (9.5" on each side)
- Laminate Base Module with Write Board above
- Includes end of run trim.

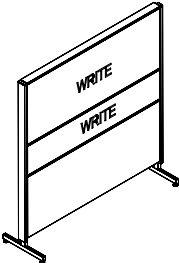
DESCRIPTION	PRODUCT CODE	LIST PRICE	DIMENSIONS/INCHES		
			H	W	D
 Freestanding Write Board Laminate Privacy Panel	EVPPH2W6624	1326	66	24	2 7/8
	EVPPH2W6630	1569	66	30	2 7/8
	EVPPH2W6636	1792	66	36	2 7/8
	EVPPH2W6642	1973	66	42	2 7/8
	EVPPH2W6648	2156	66	48	2 7/8
	EVPPH2W6654	2349	66	54	2 7/8
	EVPPH2W6660	2546	66	60	2 7/8

EVPP - MOBILE LAMINATE WRITE BOARD PRIVACY PANEL

- Includes panel with two connectors with T legs.
- 3" thick freestanding panels with 1" locking casters.
- 22" deep T-legs for stability (9.5" on each side)
- Laminate Base Module with Write Board above.
- Includes end of run trim.

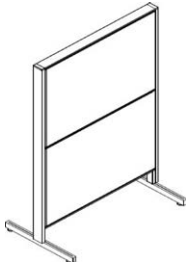
DESCRIPTION	PRODUCT CODE	LIST PRICE	DIMENSIONS/INCHES		
			H	W	D
 Mobile Write Board Privacy Panel	EVPPH2W5424M	1193	54	24	2 7/8
	EVPPH2W5430M	1340	54	30	2 7/8
	EVPPH2W5436M	1490	54	36	2 7/8
	EVPPH2W5442M	1632	54	42	2 7/8
	EVPPH2W5448M	1771	54	48	2 7/8
	EVPPH2W5454M	1922	54	54	2 7/8
	EVPPH2W5460M	2060	54	60	2 7/8

EVPP - FABRIC WRITE BOARD PRIVACY PANEL

- Includes panel with two connectors with T legs.
- 3" thick freestanding panels with leveling glides
- 22" deep T-legs for stability (9.5" on each side)
- Fabric Base Module with Write Board above
- Includes end of run trim.

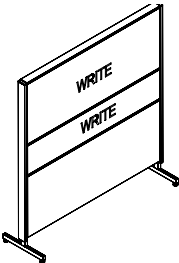
DESCRIPTION	PRODUCT CODE	LIST PRICE		DIMENSIONS/INCHES		
		GR 1	GR 2	H	W	D
 Freestanding Write Board Glazed Privacy Panel	EVPPF2W6624	1234	1252	66	24	2 7/8
	EVPPF2W6630	1446	1469	66	30	2 7/8
	EVPPF2W6636	1630	1657	66	36	2 7/8
	EVPPF2W6642	1799	1831	66	42	2 7/8
	EVPPF2W6648	1985	2017	66	48	2 7/8
	EVPPF2W6654	2154	2203	66	54	2 7/8
	EVPPF2W6660	2370	2412	66	60	2 7/8

