

electrical

**STEP-BY-STEP SPECIFICATION – 8-WIRE ELECTRICAL SYSTEM**

Step **1** **Determine the location of the source power entering the Panel Run.**

1. At the base of the Panel.
  - (a) Use EVE8FR1 Reversible Floor Power Entry (default to EVE8FR1).
  - (b) Select the Panel to which the Floor Power Entry will be attached. This Panel requires an EVEPD Power Distribution Housing.
  - (c) Select the side of the Panel and the receptacle outlet to which the Floor Power Entry is to be attached.
2. From the ceiling.
  - (a) Use EVE8EC1 Ceiling Power Entry.
  - (b) Select the post through which to feed the Ceiling Power Entry.
  - (c) One Panel adjacent to the selected post requires an EVEPD Power Distribution Housing.
  - (d) Attach Ceiling Power entry to the nearest end of the Power Distribution Housing.

Step **2** **Determine which Panels are to be powered.**

1. Use EVE8PD Power Distribution Housing that corresponds with the width of the Panel.

**BELTLINE TIPS:**

**DO** - use a 17" long Mesh Beltline Jumper when making 90 degree turns in the Beltline raceways only.

**DO NOT** - use a 20" long Metal Flex Jumper when attempting to make 90 degree turns in the Beltline Raceways. The end connector is too long to make the turn.

**DO** - use a 20" long Metal Flex Jumper when traveling through a Beltline Post, in a straight line only.

**DO NOT** - use a 17" long Mesh Beltline Jumper Traveling through a Beltline Post, in a straight line only. The Jumper is too short to make the connection.

Step **3** **Connect power to the powered Panels.**

1. Use EVE8CP16 Jumper Cable between two adjacent powered Panels, separated by an Inline Connector.
2. Use EVE8CP18 Jumper Cable between two adjacent powered Panels separated by a post.
3. Use EVE8CP Pass-Through Cables to connect powered Panels that are separated by one or more non-powered Panels (maximum distance between the powered Panels is 16 feet).
  - (a) The length of the Pass-Through Cable is calculated by adding together the widths of the non-powered Panels (that separate the two powered Panels) and applying an additional 16" to the total. (EVE8PD Power Distribution Housing is positioned 8" in from the ends of the powered Panel.) (b) An additional 3" must be added to the Pass-Through Cable for each post that the cable passes through.
4. From the price list, select the EVE8CP Pass-Through Cable that matches the calculated length. If the length is between listed sizes, use the next size up.

Step **4** **Determine the location and circuitry of the receptacles.**

1. Each powered Panel has four (4) potential locations for EVE8RD Duplex Receptacles – 2 per side. (Exception: 24" wide Panel has only two potential locations – 1 per side, 18" wide Panel has no locations for receptacles.)
2. At each receptacle location there is a choice of four circuit options. Select a circuit option for each location. Circuits one & two are utility circuits; circuits A & B are dedicated circuits.

**EVOLVE'S MODIFIED 8-WIRE ELECTRICAL SYSTEM**

Evolve has modified its 8-Wire Electrical System to stay abreast of changing industry standards.

Evolve's electrical system allows for the integration of the commonly required "2+2" configuration (2 utility circuits, 2 dedicated circuits) found in the source power of most of today's North American buildings.

**This system is rated for connection to:**

1. A grounded 120/240V, single phase, 20 A, 60Hz
2. A 120/208V, 3 phase, 20 A, 60Hz branch circuit

**EQUIPMENT AMPERAGE**

Calculator .....	0.25
Electric Eraser .....	0.50
Pencil Sharpener .....	1.00
Radio .....	0.05
Paper Shredder.....	4.40 - 13.00
Electric Typewriter .....	1.20
Personal Computer.....	2.00 - 4.00
Video Display Terminal .....	0.08
Draft / Letter Quality Printer.....	1.20 - 3.00

**Data/Comm**

Evolve's duplex receptacle openings will now conform to the ANSI/TIA/EIA Furniture Opening Standard of 1.38 +/- .035 x 2.71 +/- .04. There will no longer be the need to use adapter plates to reduce the size of Evolve's raceway opening, or to use Evolve dedicated data plates for data/comm terminations.

**Transition**

A transition cable is available to connect the previous electrical system prior to April 1, 2005 to the current system when adding Panels to an existing installation. Also, new raceway covers with the smaller openings can be provided and applied to existing Panels when retrofitted with new electrics.

Fan.....	1.00
Heater.....	8.50 - 12.50
Coffee Pot.....	15.00
Task Light .....	1.00
Slide Projector.....	2.00 - 6.00
Laser Printer .....	5.00 - 8.00
Processor / Disk Unit .....	1.00 - 10.00
Desk Top Plotter.....	1.50

Some equipment, such as large copiers, printers, plotters, heaters and coffee makers may occupy most of the circuit capacity. It is recommended that such devices be supplied with the power directly from the wall or building receptacle.

WIRING SCHEMATIC

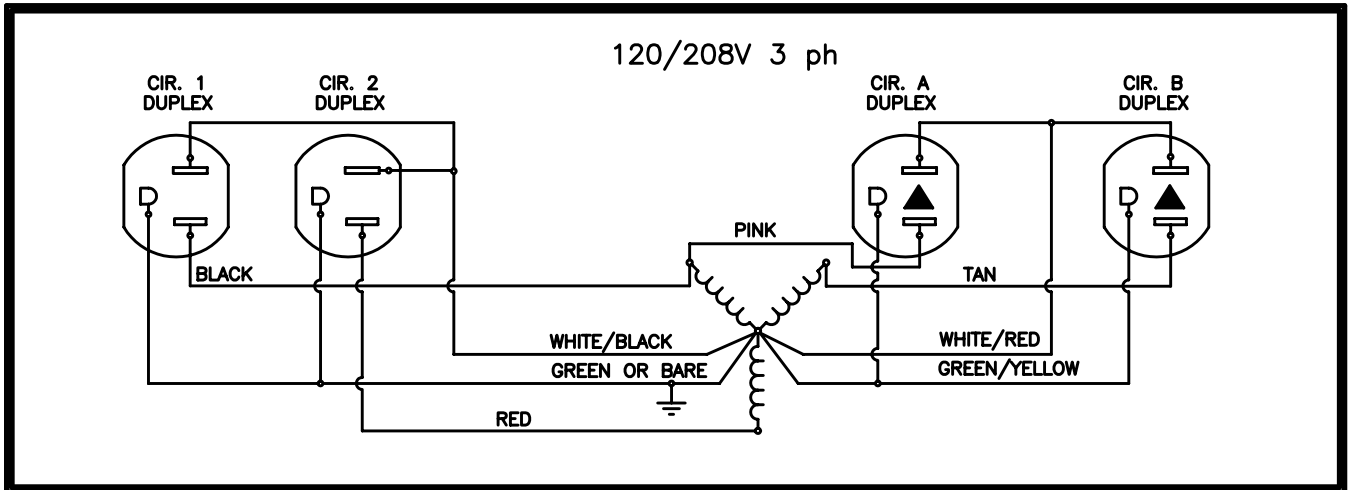
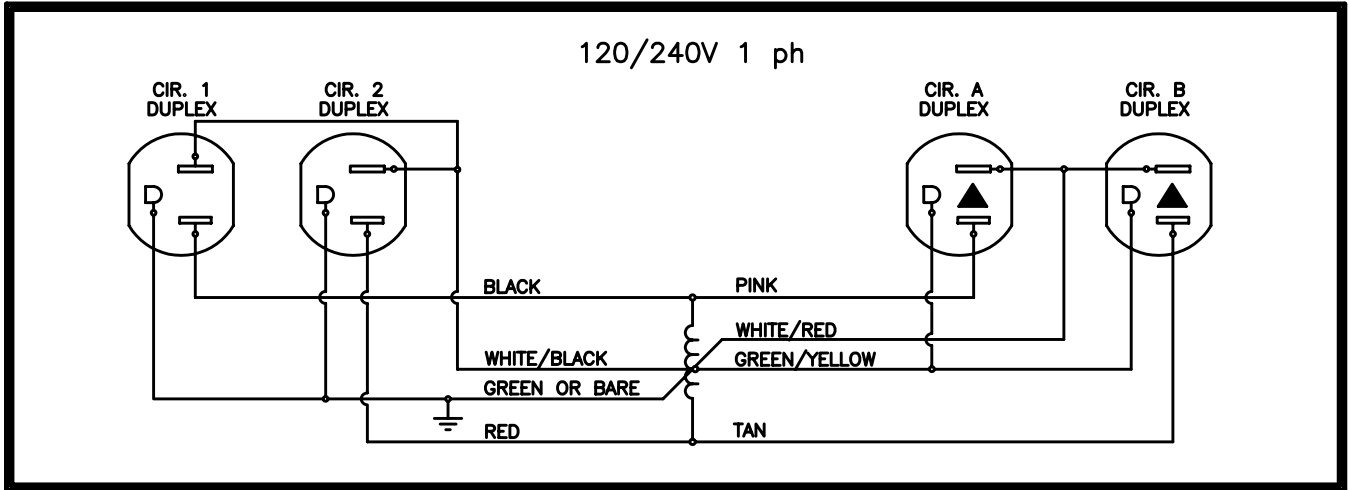

**DEFINING “2 + 2” WIRING CONFIGURATIONS**

**2 + 2 Configuration (8 wire, 4 circuit)**

Two Utility Circuits [Evolve’s #1 & #2 circuits] share one neutral wire and one ground wire.  
 (2 hot [circuit] wires + 1 neutral wire\*\*\* + 1 green ground wire\* = 4 wires)

Two Dedicated Circuits [Evolve’s “A” & “B” circuits] share one neutral wire and one ground wire.  
 (2 hot [circuit] wires + 1 neutral wire\*\*\* + 1 green/yellow ground wire\*\* = 4 wires)

**NOTE:**

It is the ground wire that makes the difference between “Utility” and “Dedicated” circuits. Refer to Wiring Schematics found in the Price List.

\* A Green ground wire is a “system” ground. This means it could be grounded to any piece of metal, including the Panel.

\*\* A Green/Yellow ground wire is isolated, within the wiring conduit, all the way back to the box at the source (building ground).

\*\*\* All Neutral Wires are 10 gauge rather than 12 gauge meaning they are larger than normal, allowing greater protection against “noise” or interference on the circuit.

This page provides an exploded view of a sample configuration highlighting each **Electrical** component required when specifying this configuration.

**Components**

- A. EVE8PD42** Power Distribution Housing  
Note: 8 wire, 4 circuits (3rd/4th circuits dedicated) labeled A or B.
- B. EVE8CP16** Jumper Cable  
Note: EVE8CP16 connects two powered panels positioned side by side, separated by an Inline Connector  
EVE8CP18 connects two powered panels separated by a post.
- C. EVE8RD** Duplex Receptacle
- D. EVE8CP** Pass-Through Cable  
Note: Pass-Through Extension Cable (EVE8CPF154) available – extends power capability beyond 208".

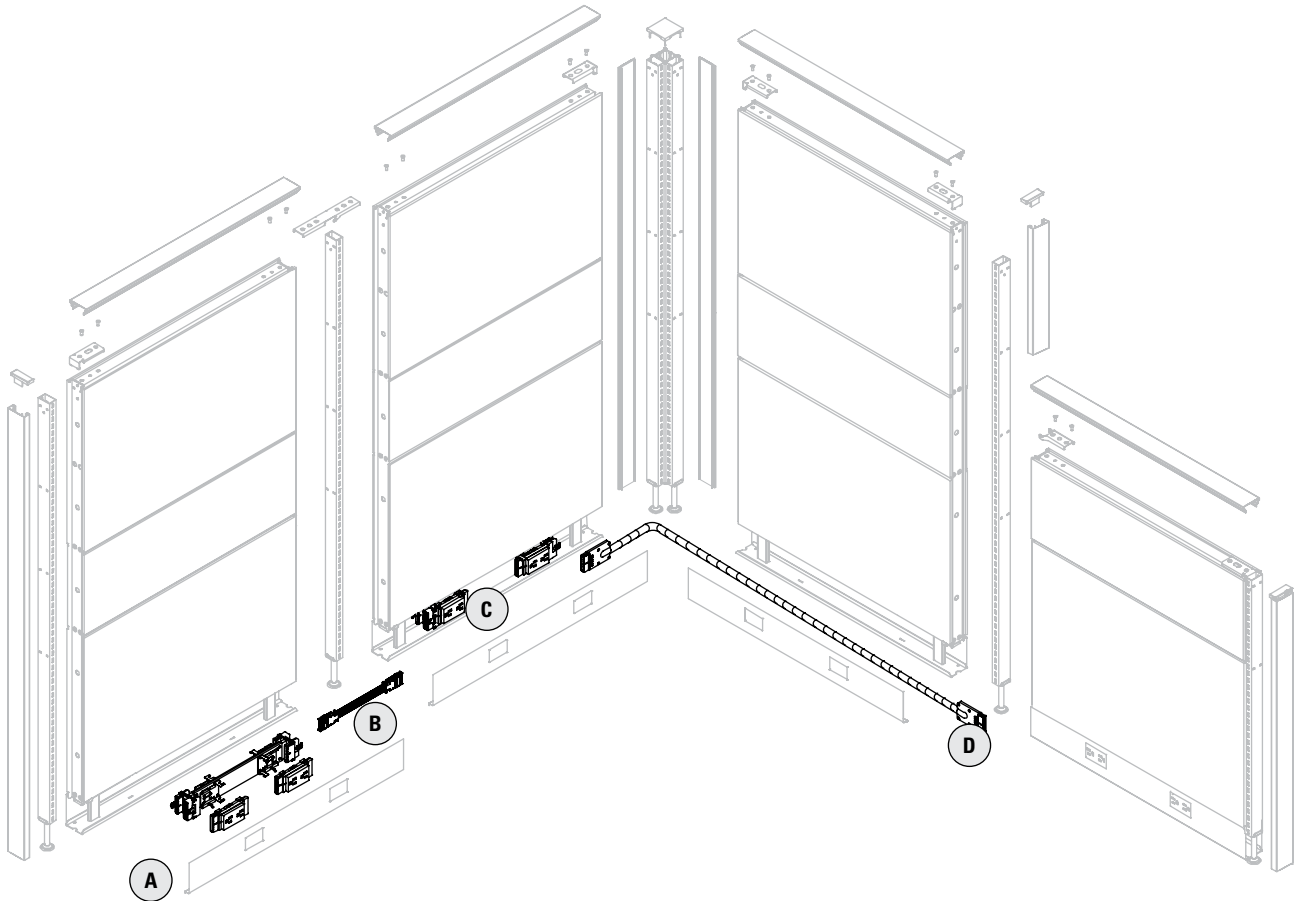

This page provides an exploded view of a sample configuration highlighting each **Beltline Power Panel** component required when specifying this configuration.

- A. EVE8PD36** Power Distribution Housing  
 Note: 8 wire, 4 circuits (3rd/4th circuits dedicated) labeled A or B.
- E. EVE8CP18** Jumper Cable  
 Note: EVE8CP18 connects two powered panels separated by a post, in a straight line.
- B. EVE8CP17** Jumper Cable  
 Note: EVE8CP17 connects two powered panels positioned side by side, separated by an Inline Connector
- F. EVE8CP17** Jumper Cable  
 Note: EVE8CP17 connects two powered panels separated by a post, for turns through post.
- C. EVE8RD** Duplex Receptacle
- G. EVE8CPCP** Base to Belt Pass Through Kit  
 Note: For use in Chimney Panels only.
- D. EVE8CP** Pass-Through Cable  
 Note: Pass-Through Extension Cable (EVE8CPF154) available – extends power capability beyond 208”.

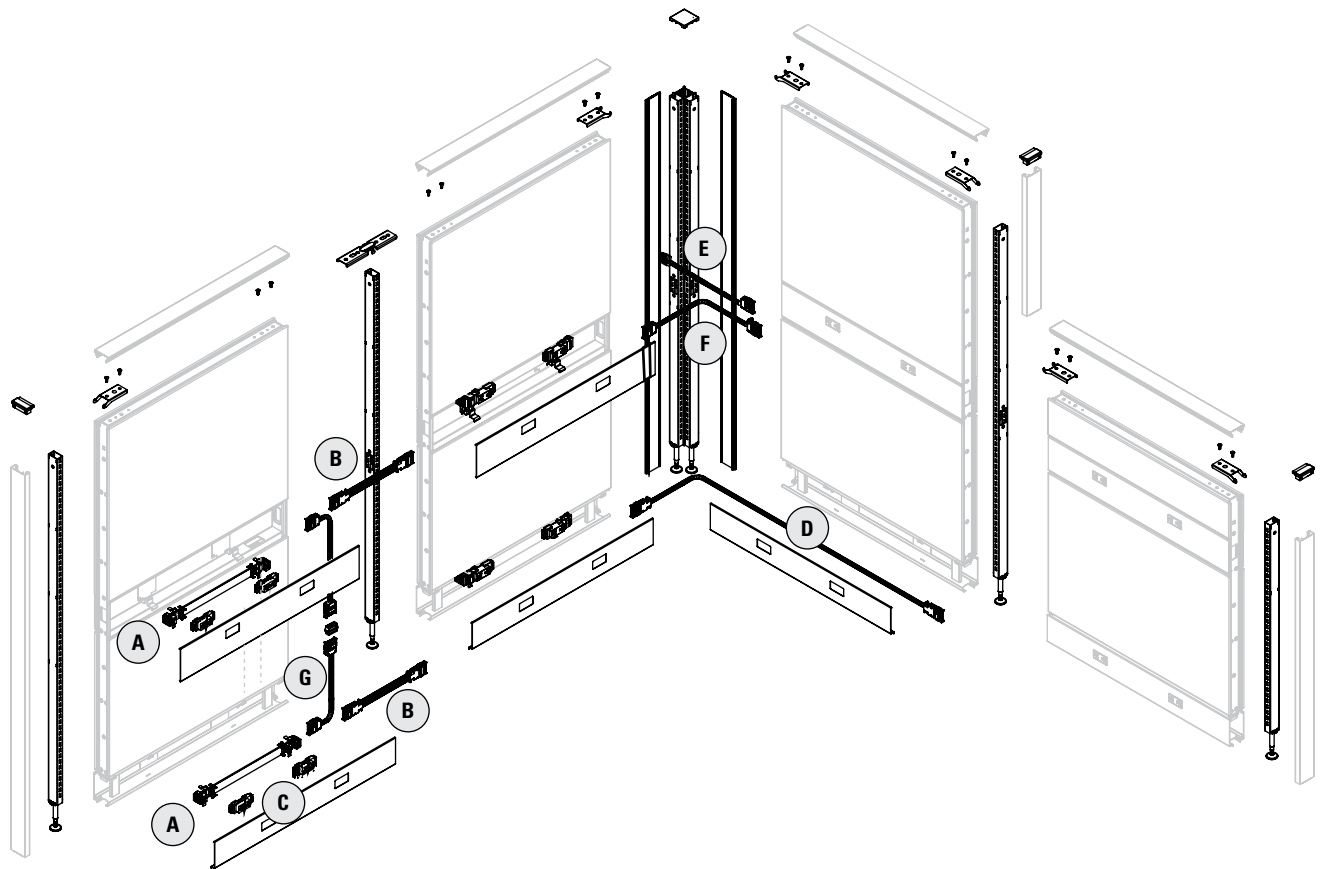

# ELECTRICAL

## EVE8PD - POWER DISTRIBUTION HOUSING

- Power housing is specified per panel size (e.g. EVE8PD36 is for use in a 36" panel).
- 8 wire, 4 circuits (2+2 configuration).
- Provides two duplex receptacles per panel side on all panel widths except the 24" wide panel.
- 24" wide panel allows for only one (1) duplex receptacle per panel side.
- Each power distribution housing supports 15-20 amps.

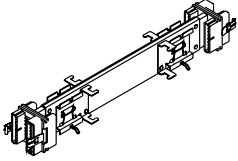
DESCRIPTION	PRODUCT CODE	LIST PRICE	DIMENSIONS/INCHES		
			H	L	D
 Power Distribution Housing	EVE8PD24	175		6 1/4	
	EVE8PD30	236		11 1/2	
	EVE8PD36	248		17 1/2	
	EVE8PD42	254		23 1/2	
	EVE8PD48	275		29 1/2	
	EVE8PD54	277		39 1/4	
	EVE8PD60	278		41 1/2	

## EVE8CP16 - JUMPER CABLE

- The EVE8CP16 electrically connects two powered panels positioned side by side, separated by an Inline connector.

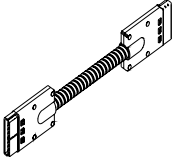
DESCRIPTION	PRODUCT CODE	LIST PRICE	DIMENSIONS/INCHES		
			H	L	D
 Jumper Cable	EVE8CP16	146		16	

## EVE8CP - FLEXIBLE MESH JUMPER CABLE

- Used to connect two power distribution housings at the beltline level at 90 degrees.
- 18.5" flexible mesh jumper replaces EVE8CP20 jumper for corner post applications.

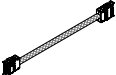
DESCRIPTION	PRODUCT CODE	LIST PRICE	DIMENSIONS/INCHES		
			H	L	D
 Flexible Mesh Jumper Cable	EVE8CP17	135		17 1/2	
	EVE8CP18	167		18 1/2	

## EVE8CPCP - CHIMNEY PANEL JUMPER CABLE KIT

- Contains two (2) 17" flexible harnesses and one (1) "I" connector.
- Used to connect electric from the base to the beltline raceway in Beltline Powered Chimney panel.
- Must use in conjunction with base power distribution harness and beltline power distribution harness (sold separately).

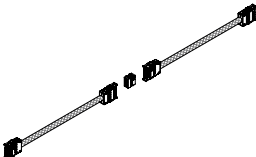
DESCRIPTION	PRODUCT CODE	LIST PRICE	DIMENSIONS/INCHES		
			H	L	D
 Chimney Panel Jumper Cable Kit	EVE8CPCP	365			

# ELECTRICAL

## EVE8CPXX-H - PASS-THROUGH CABLE

- Flexible metal conduit with wire mesh distributes electrical power through non-powered beams.
- To calculate the length of a Pass-Through Cable, add the widths of the non-powered panels separating the powered panels (panels with distribution housing attached). To this, add 16" (distance from the edge of the panel to the distribution housing x 2).
- Add additional 3" when passing through a post. See the Tips at the beginning of the section for more details.
- Hybrid pass-through cables with wire mesh allows connection at 90 degree post at one end for Evolve panels including Beltline and Power Beam

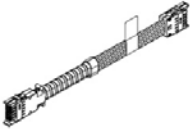
	DESCRIPTION	PRODUCT CODE	LIST PRICE	DIMENSIONS/INCHES		
				H	L	D
	Pass-Through Cable	EVE8CP40-H	226		40	
		EVE8CP46-H	234		46	
		EVE8CP52-H	240		52	
		EVE8CP58-H	255		58	
		EVE8CP64-H	266		64	
		EVE8CP70-H	274		70	
		EVE8CP76-H	277		76	
		EVE8CP82-H	288		82	
		EVE8CP88-H	298		88	
		EVE8CP94-H	305		88	
		EVE8CP100-H	315		100	
		EVE8CP106-H	330		106	
		EVE8CP118-H	346		118	
		EVE8CP130-H	380		130	
		EVE8CP142-H	397		142	
		EVE8CP154-H	416		154	
		EVE8CP172-H	447		172	
	EVE8CP190-H	468		190		
	EVE8CP208-H	486		208		

## EVE8CI-1 - "I" CONNECTOR

- Female - Female connector used to connect two Pass-Through Cables

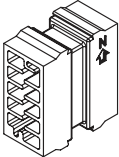
	DESCRIPTION	PRODUCT CODE	LIST PRICE	DIMENSIONS/INCHES		
				H	W	D
	"I" Connector	EVE8CI-1	101			

# ELECTRICAL

## EVE8RD - DUPLEX RECEPTACLE - 15 AMPS

- Duplex receptacles are rated for 15 Amps.
- EVE8RD1 = Circuit #1 (utility circuit)
- EVE8RD2 = Circuit #2 (utility circuit)
- EVE8RDA = Circuit A (dedicated)
- EVE8RDB = Circuit B (dedicated)

### NOTE:

- EVE8RD1 and EVE8RD2 (#1 and #2 share common ground)
- EVE8RDA and EVE8RDB (A and B share common ground)
- Up to 6 receptacles per circuit (24 per infeed), not to exceed total of 15 Amps per circuit.
- Standard in black. Available in White or Nevada with upcharge.

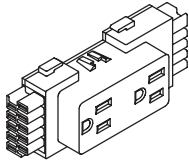
DESCRIPTION	PRODUCT CODE	LIST PRICE	DIMENSIONS/INCHES		
			H	W	D
 Duplex Receptacle	EVE8RD1	39	2	4 5/8	1 1/4
	EVE8RD2	39	2	4 5/8	1 1/4
	EVE8RDA	39	2	4 5/8	1 1/4
	EVE8RDB	39	2	4 5/8	1 1/4
	EVE8RD1SND	44	2	4 5/8	1 1/4
	EVE8RD2SND	44	2	4 5/8	1 1/4
	EVE8RDASND	44	2	4 5/8	1 1/4
	EVE8RDBSND	44	2	4 5/8	1 1/4
	EVE8RD1WHT	44	2	4 5/8	1 1/4
	EVE8RD2WHT	44	2	4 5/8	1 1/4
	EVE8DAWHT	44	2	4 5/8	1 1/4
	EVE8RDBWHT	44	2	4 5/8	1 1/4

## EVE8RD - DUPLEX RECEPTACLE - 20 AMPS

- Duplex receptacles are rated for 20 Amps.
- EVE8RD1-20 = Circuit #1 (utility circuit)
- EVE8RD2-20 = Circuit #2 (utility circuit)
- EVE8RDA-20 = Circuit #A (dedicated)
- EVE8RDB-20 = Circuit #B (dedicated)

### NOTE:

- EVE8RD1-20 and EVE8RD2-20 (#1 and #2 share common ground)
- EVE8RDA-20 and EVE8RDB-20 (A and B share common ground)
- Up to 6 receptacles per circuit (24 per infeed) not to exceed total 20 Amps per circuit
- Standard in black. Available in White or Nevada with upcharge.

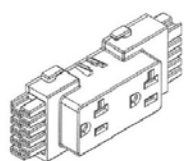
DESCRIPTION	PRODUCT CODE	LIST PRICE	DIMENSIONS/INCHES		
			H	W	D
 Duplex Receptacle 20 amps	EVE8RD1-20	60	2	4 5/8	1 1/4
	EVE8RD2-20	60	2	4 5/8	1 1/4
	EVE8RDA-20	60	2	4 5/8	1 1/4
	EVE8RDB-20	60	2	4 5/8	1 1/4
	EVE8RD1-20SND	66	2	4 5/8	1 1/4
	EVE8RD2-20SND	66	2	4 5/8	1 1/4
	EVE8RDA-20SND	66	2	4 5/8	1 1/4
	EVE8RDB-20SND	66	2	4 5/8	1 1/4
	EVE8RD1-20WHT	66	2	4 5/8	1 1/4
	EVE8RD2-20WHT	66	2	4 5/8	1 1/4
	EVE8RDA-20WHT	66	2	4 5/8	1 1/4
	EVE8RDB-20WHT	66	2	4 5/8	1 1/4

# ELECTRICAL

## EVE8RD1CA - CONTROLLED DUPLEX RECEPTACLE

- Meets California Title 24, Federal and LEED certification guidelines
- Allows circuit to be controlled or switched off when utility is not in use.
- Duplex receptacles are rated for 15 Amps.
- EVE8RD1CA = Circuit #1 (utility circuit)
- EVE8RD2CA = Circuit #2 (utility circuit)
- EVE8RDACA = Circuit A (dedicated)
- EVE8RDBCA = Circuit B (dedicated)

## NOTE:

- EVE8RD1CA and EVE8RD2CA (#1 and #2 share common ground)
- EVE8RDACA and EVE8RDBCA (A and B share common ground)
- Up to 6 receptacles per circuit (24 per infeed), not to exceed total of 15 Amps per circuit.
- Available in BLK finish only.

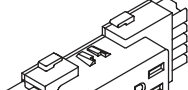
	DESCRIPTION	PRODUCT CODE	LIST PRICE	DIMENSIONS/INCHES		
				H	W	D
	Duplex Receptacle	EVE8RD1CA	42	2	4 5/8	1 1/4
		EVE8RD2CA	42	2	4 5/8	1 1/4
		EVE8RDACA	42	2	4 5/8	1 1/4
		EVE8RDBCA	42	2	4 5/8	1 1/4

## EVE8RD - DUPLEX RECEPTACLE TO CONVERT STANDARD 2 + 2 SYSTEM TO 3 + 1

- Duplex receptacle are rated for 15 Amps
- EVE8RDA-4 = Duplex receptacle A without triangle to be utility circuit
- EVE8RDB-4 = Duplex receptacle B without triangle to be utility circuit
- Up to 6 receptacles per circuit (24 per infeed) not to exude total 15 Amps per circuit
- Standard in black. Available in White or Nevada with upcharge.

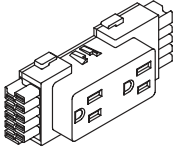
	DESCRIPTION	PRODUCT CODE	LIST PRICE	DIMENSIONS/INCHES		
				H	L	D
	Duplex Receptacle	EVE8RDA-4	39	2	4 5/8	1 1/4
		EVE8RDB-4	39	2	4 5/8	1 1/4
		EVE8RDA-4SND	42	2	4 5/8	1 1/4
		EVE8RDB-4WHT	42	2	4 5/8	1 1/4
		EVE8RDA-4SND	42	2	4 5/8	1 1/4
		EVE8RDA-4WHT	42	2	4 5/8	1 1/4

## EVEUSB01 - USB MODULE

- Includes two USB ports.
- Available in White and Black.

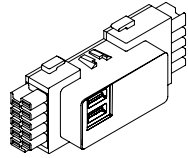
	DESCRIPTION	PRODUCT CODE	LIST PRICE	DIMENSIONS/INCHES		
				H	L	D
	USB Module - White	EVEUSB01WHT	242	2	4 5/8	1 1/4
	USB Module - Black	EVEUSB01BLK	242	2	4 5/8	1 1/4

# ELECTRICAL

## EVE8FR1 - REVERSIBLE FLOOR POWER ENTRY

- Takes the place of a duplex receptacle by snapping into the base power way or Beltline power way.
- Includes 72" long flexible vinyl conduit.
- Must be hard wired to source power by a licensed electrician.
- Diameter is 0.85"

## EVE8FR2 - REVERSIBLE FLOOR POWER ENTRY

- Takes the place of a duplex receptacle by snapping into the base power way or Beltline power way.
- Includes 144" long flexible vinyl conduit.
- Must be hard wired to source power by a licensed electrician.
- Diameter is 0.85"

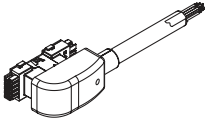
	DESCRIPTION	PRODUCT CODE	LIST PRICE	DIMENSIONS/INCHES		
				H	L	D
	Reversible Floor Power Entry	EVE8FR1	393		72	
		EVE8FR2	509		144	

## EVE8F - FLOOR POWER ENTRY

- Snaps in end of power distribution housing.
- Includes flexible vinyl conduit.

- Must be hard wired to source power by a licensed electrician.
- Diameter is 0.85"

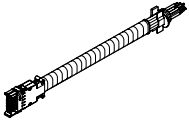
	DESCRIPTION	PRODUCT CODE	LIST PRICE	DIMENSIONS/INCHES		
				H	L	D
	Floor Power Entry	EVE8F1P	381		72	
		EVE8F2P	493		144	

## VE8EC - CEILING POWER ENTRY

- Snaps into the end of a Power Distribution Housing.
- Flexible metal conduit extends into the ceiling through a corner post and post extension.
- Must be hard wired to source power by a licensed electrician.
- 4" junction box included.

- Post extension ordered separately
- Can feed directly into beltline power when Beltline Post Connectors are specified.
- Cannot feed through Inline or End-of-run Connectors.

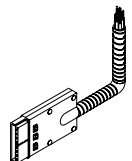
	DESCRIPTION	PRODUCT CODE	LIST PRICE	DIMENSIONS/INCHES		
				H	L	D
	Ceiling Power Entry	EVE8EC1	304		132	
		EVE8EC2	532		144	
		EVE8EC3	600		180	

## EVEENY-2 - HARDWARE POWER ENTRY BOX - NEW YORK

- A licensed electrician must provide hard wire connection within the junction box.
- Not for use in panels less than 36"W.

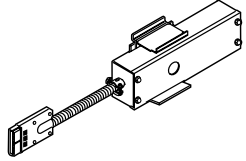
	DESCRIPTION	PRODUCT CODE	LIST PRICE	DIMENSIONS/INCHES		
				H	W	D
	Hardware Power Entry Box - New York	EVEENY2	503	3	28	2 1/5

# ELECTRICAL

## EVEJBC-1 - HARDWARE JUNCTION BOX - CHICAGO

- Can be retrofitted in any size of panel at the receptacle location.
- Gives access from one side only at each location.
- Customer to supply conduit, wiring, receptacle, and face plate.
- 2 per panel, except 24" panels only one is needed.
- A licensed electrician must provide hardware connection with the junction box.

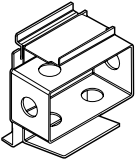
DESCRIPTION	PRODUCT CODE	LIST PRICE	DIMENSIONS/INCHES		
			H	W	D
 Hardware Junction Box - Chicago	EVEJBC-1	116			

## EVDP6E - POST EXTENSION DATA/COMM LAY-IN

- Attaches to the top of a post to bring power and/or data cables from the ceiling to the panel power way
- Three-sided power pole with snap-on fourth side.
- Post extension can be opened on one side for lay-in or power and/or data cables.
- Made of aluminum and can be field cut.
- Accommodates up to 25CAT 5 Cables with electric. Accommodates up to 45 CAT 5 Cables without electric.
- Actual size interior dimension of post, 1.80" x 1.80"

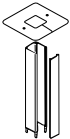
DESCRIPTION	PRODUCT CODE	LIST PRICE	DIMENSIONS/INCHES		
			H	W	D
 Post Extension Data/Comm Lay-in	EVDP6E4	195	64	2	
	EVDP6E8	236	82	2	

## EVDP6E - 60° POST EXTENSION DATA/COMM LAY-IN

- Attaches to the top of at 60° corner post to bring power and/or data cables from the ceiling to the panel power way.
- Two-sided power pole with snap-on third side.
- Post extension can be opened on one side for lay-in or power and/or data cables.
- Made of aluminum and can be field cut.
- Accommodates up to 6 CAT 5 Cables with electric. Accommodates up to 20 CAT 5 Cables without electric.

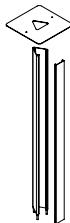
DESCRIPTION	PRODUCT CODE	LIST PRICE	DIMENSIONS/INCHES		
			H	W	D
 60° Post Extension Data/Comm Lay-in	EVDP6E4	195	64	2	
	EVDP6E8	236	82	2	

# ELECTRICAL

## EVDP4E - 45° POST EXTENSION DATA/COMM LAY-IN

- Attaches to the top of at 45° corner post to bring power and/or data cables from the ceiling to the panel power way.
- Two-sided power pole with snap-on third side.
- Post extension can be opened on one side for lay-in or power and/or data cables.
- Made of aluminum and can be field cut.
- Accommodates up to 6 CAT 5 Cables with electric. Accommodates up to 20 CAT 5 Cables without electric.

DESCRIPTION	PRODUCT CODE	LIST PRICE	DIMENSIONS/INCHES		
			H	W	D
45° Post Extension Data/Comm Lay-in	EVDP4E64	204	64	3.65	
	EVDP4E84	204	84	3.65	

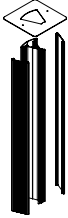

## EVLEDES - STARTER LED TASK LIGHT

- Undercabinet slim profile LED linear light fixture with lens and On/Off switch.
- May be used as stand-alone or extended with add-on section below (EVLEDES\_DSC).
- Plug-in power supply with 72" cord length plus 78" DC cable.
- Includes magnet mounting bracket with optional adhesive metal plate.
- Light enclosure in clear anodizing finish. Color temperature cool white 4000K.
- Lifespan rated 30,000 hours.

DESCRIPTION	PRODUCT CODE	LIST PRICE	DIMENSIONS/INCHES		
			H	W	D
Led Task Light	EVLEDES24	297	1	22.9	1
	EVLEDES36	341	1	33.5	1
	EVLEDES48	379	1	45.5	1

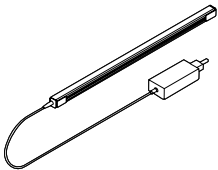

## EVLEDES - ADD-ON LED TASK LIGHT

- Undercabinet slim profile LED linear add-on light fixture with lens.
- Daisy chain unit with 39" linking cable, no power supply.
- Add-on units can only be linked up to a total of 48 watts per power supply; this is equivalent to 10 feet of nominal length of light per power supply.
- Includes magnet mounting bracket with optional adhesive metal plate. Light enclosure in clear anodizing finish. Color temperature cool white 4000K. Lifespan rated 30,000 hours.

DESCRIPTION	PRODUCT CODE	LIST PRICE	DIMENSIONS/INCHES		
			H	W	D
Led Task Light	EVLEDES24DSC	243	1	24	39
	EVLEDES36DSC	286	1	36	39
	EVLEDES48DSC	325	1	48	39

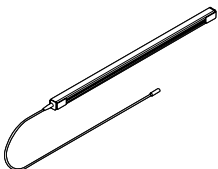

# ELECTRICAL

## EVLEDESOS - OCCUPANCY SENSOR

- Inline add-on controller for dimming and occupancy sensor.
- Sensor bypass switch.

	DESCRIPTION	PRODUCT CODE	LIST PRICE	DIMENSIONS/INCHES		
				H	W	D
	Occupancy Sensor	EVLEDESOS	122	6	2.4	2

## EVELEDVS - VOYAGE LED SINGLE LIGHT FIXTURE

- Single arm option with 6 ft. cord.
- Touch & hold dimming capability.
- Brightness adjustment from 100% to 15%.
- Available in Designer White (WHT), Black (BLK) or Silver (SIL).
- Mercury free LEDs and 94% post consumer recyclability by weight.
- Mounting accessories sold separately.

	DESCRIPTION	PRODUCT CODE	LIST PRICE	DIMENSIONS/INCHES		
				H	W	D
	Voyage LED Single Light Fixture	EVELEDVS	817			
	Voyage LED Single Light Fixture w/Occupancy Sensor	EVELEDVSO	1210			

## EVELEDVD - VOYAGE LED DOUBLE LIGHT FIXTURE

- Double arm option with 6 ft. cord.
- Touch & hold dimming capability.
- Brightness adjustment from 100% to 15%.
- Available in Designer White (WHT), Black (BLK) or Silver (SIL).
- Mercury free LEDs and 94% post consumer recyclability by weight.
- Mounting accessories sold separately.

	DESCRIPTION	PRODUCT CODE	LIST PRICE	DIMENSIONS/INCHES		
				H	W	D
	Voyage LED Double Light Fixture	EVELEDVD	830			
	Voyage LED Double Light Fixture w/Occupancy Sensor	EVELEDVDO	1227			

## EVELEDRS - REVO LED SINGLE LIGHT FIXTURE

- Single arm option with 9 ft. cord.
- Touch & hold dimming capability.
- Brightness adjustment from 100% to 15%.
- Available in Designer White (WHT), Black (BLK) or Silver (SIL).
- Mercury free LEDs and 94% post consumer recyclability by weight.
- Mounting accessories sold separately.

	DESCRIPTION	PRODUCT CODE	LIST PRICE	DIMENSIONS/INCHES		
				H	W	D
	Revo LED Single Light Fixture	EVELEDRS	817			
	Revo LED Single Light Fixture w/Occupancy Sensor	EVELEDRSO	1210			

# ELECTRICAL

## EVELEDRD - REVO LED DOUBLE LIGHT FIXTURE

- Double arm option with 9 ft. cord.
- Touch & hold dimming capability.
- Brightness adjustment from 100% to 15%.
- Available in Designer White (WHT), Black (BLK) or Silver (SIL).
- Mercury free LEDs and 94% post consumer recyclability by weight.
- Mounting accessories sold separately.

	DESCRIPTION	PRODUCT CODE	LIST PRICE	DIMENSIONS/INCHES		
				H	W	D
	Revo LED Double Light Fixture	EVELEDRD	830			
	Revo LED Double Light Fixture w/Occupancy Sensor	EVELEDRDO	1227			

## EVELEDAFS - FREESTANDING BASE

	DESCRIPTION	PRODUCT CODE	LIST PRICE	DIMENSIONS/INCHES		
				H	W	D
	Freestanding Base	EVELEDAFS	232			

## EVELEDACM - CLAMP MOUNT

	DESCRIPTION	PRODUCT CODE	LIST PRICE	DIMENSIONS/INCHES		
				H	W	D
	Clamp Mount	EVELEDACM	207			

## EVELEDASW - SLATWALL MOUNT

	DESCRIPTION	PRODUCT CODE	LIST PRICE	DIMENSIONS/INCHES		
				H	W	D
	Slatwall Mount	EVELEDASW	207			

# ELECTRICAL

## EVELEDAPM - PANEL MOUNT

	DESCRIPTION	PRODUCT CODE	LIST PRICE	DIMENSIONS/INCHES		
				H	W	D
	Panel Mount	EVELEDAPM	207			

## EVELEDASM - SURFACE MOUNT

	DESCRIPTION	PRODUCT CODE	LIST PRICE	DIMENSIONS/INCHES		
				H	W	D
	Surface Mount	EVELEDASM	207			

## EVECC - CORD COVER

- Attaches to panels vertically between modules to provide enclosures for power or data cords.
- Available in 21" and 36" lengths, 6 per pack.
- Can be field cut to required length.

	DESCRIPTION	PRODUCT CODE	LIST PRICE	DIMENSIONS/INCHES		
				H	W	D
	Inline Cord Cover	EVECC121	38	21		
	For use at panel Inline connections	EVECC136	57	36		
	Corner Cord Cover	EVECC221	38	21		
	For use at panel Inline connections	EVECC236	57	36		

## EVH8RC - RACEWAY COVERS

- Raceway Cover with 1.38" x 2.71" duplex receptacle openings.
- Raceway Covers are sold individually.
- Includes up to three receptacle opening shields depending on width of raceway cover.

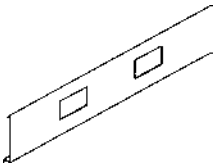
	DESCRIPTION	PRODUCT CODE	LIST PRICE	DIMENSIONS/INCHES		
				H	W	D
	Raceway Covers	EVH8RC18	27	6	18	
		EVH8RC24	39	6	24	
		EVH8RC30	53	6	30	
		EVH8RC36	59	6	36	
		EVH8RC42	66	6	42	
		EVH8RC48	71	6	48	
		EVH8RC54	83	6	54	
		EVH8RC60	91	6	60	

# ELECTRICAL

## EVEMAE - MINI-ADAPT POWER MODULE

- Attaches to scoop at the back of the worksurface.
- Includes two Simplex outlets.
- 6' black cord
- Available in black only.
- Note: Height (H) is measured above the worksurface.

	DESCRIPTION	PRODUCT CODE	LIST PRICE	DIMENSIONS/INCHES		
				H	W	D
	Mini-Adapt Power Module	EVEMAE1	250	2	3.58	3

## EVEMAD - MINI-ADAPT POWER MODULE

- Attaches to scoop at the back of the worksurface.
- Includes two Voice/Data Port, Voice/Data Adapter Kit.
- Accepts Cat3, Cat 5, Cat 5e, Cat 6 jacks.
- Available in black only.
- Note: Height (H) is measured above the worksurface.

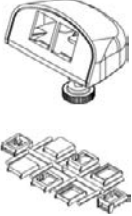
	DESCRIPTION	PRODUCT CODE	LIST PRICE	DIMENSIONS/INCHES		
				H	W	D
	Mini-Adapt Power Module	EVEMAD1	203	2	3.58	3

## EVED50AC - CLAMP MOUNT 2 POWER/USB-A&C

- Ashley Duo clamp mount power module with two 15 amp 120 Volt AC receptacles
- 2.4 amp USB-A port and 60 watt USB-C power delivery port
- 10' power cord with molded plug
- UL listed: UL 962A.
- Clamp accommodates worksurfaces 0.5" to 1.5" thick
- Fastened with thumb screws.

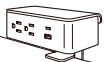
	DESCRIPTION	PRODUCT CODE	LIST PRICE	DIMENSIONS/INCHES		
				H	W	D
	White Module, Silver Bracket	EVED50ACW	525	1.8	5.5	2.8
	Black Module, Silver Bracket	EVED50ACB	525	1.8	5.5	2.8

## EVEDU51AC - UNDER MOUNT 2 POWER/USB-A&C

- Ashley Duo under mount power module with two 15 amp 120 Volt AC receptacles.
- 2.4 amp USB-A port and 60 watt USB-C power delivery port.
- 10' power cord with molded plug.
- UL listed: UL 962A.
- Mountable under most worksurfaces.
- Installation template provided.

	DESCRIPTION	PRODUCT CODE	LIST PRICE	DIMENSIONS/INCHES		
				H	W	D
	White Module, Silver Bracket	EVEDU51ACW	525	3	5.5	3.2
	Black Module, Silver Bracket	EVEDU51ACB	525	3	5.5	3.2