

panels

## TECHNICAL FEATURES OF EVOLVE PANELS:

- Evolve Panels are 2 7/8" thick.
- An aluminum low profile top cap is included with the panel.
- Base Raceway will allow for 140 data cables without electrical, or 48 data cables with electrical.
- Beltline Raceway will allow for 65 data cables without electrical or 54 data cables with electrical.
- 90 degree post extension will allow for 45 data cables without electric and 25 data cables with electric.
- Raceway knockout openings are 1.38" x 2.71".
- Acoustic Rating: .65 = NRC - Noise Reduction Coefficient
- STC: 23 = Sound Transmission Coefficient

## BASIC FEATURES OF EVOLVE PANELS:

- Evolve Segmented Panels are available in four (4) basic heights: 30", 42", 54" and 66"; and eight (8) widths: 18", 24", 30" 36", 42", 48", 54" High and 60".
- Evolve Monolithic Panels are available in four (4) basic heights: 42", 48", 54" and 66"; and eight (8) widths: 18", 24", 30" 36", 42", 48", 54" and 60".
- Evolve Panels must include the same segmentation on both sides of the panel. Cannot be Monolithic on one side and Segmented on the other.
- Opposite sides of each Fabric Module may have a different fabric within the same grade at no upcharge.
- If different grades of fabric are used on one panel, the entire panel must be priced at the highest grade.
- There is no panel creep in a straight Panel-to-Panel configuration; however, a corner post (2, 3, 4 way) will add 3.25" inches to a panel run.
- All Fabric Acoustic Panels (EVPFA) are composed of a 6" raceway module and a 24" base-height module which create the EVPFA30. Subsequent heights are created by adding either a 12" high module to create an EVPFA42 or a 24" high module to create an EVPFA54. The addition of both 12" and 24" modules creates a EVPFA66.
- In contrast, a Premium Panel (EVFPF) is composed of a 6" raceway module, a 24" base-height module and either two (2) or three (3) 12" modules which make up the two premium heights: EVFPF54 and EVFPF66.
- All Panels available with Aluminum trim as a standard option.
- Individual fabric covered acoustic modules incorporated into a rigid steel frame.
- Raceway covers included with panels
- Beltline Panels contain a 6" Power Belt Module that is metal with knockouts on both sides.

## BASIC FEATURES OF EXTENSION MODULES:

- Stackability: Evolve Panels can be increased in height in 6", 12", 18" or 24" increments. See Extension Module (pages 82-90) for part numbers.
- Panel Extension Modules stack on the top of a Panel.
- Modules can be stacked to add privacy or divide space.
- Opposite sides of a fabric module may have a different fabric within the same grade at no upcharge.
- If different grades of fabric are used on one Panel, the entire Module must be priced at highest grade.

## GENERAL WARRANTY INFORMATION:

- Panel and tackboard textiles, adjustable keyboard mechanisms, tasklights and electrical devices = ten (10) Years
- Other parts = Lifetime Warranty

MONOLITHIC PANELS - PAGES 22-27

Monolithic Panel

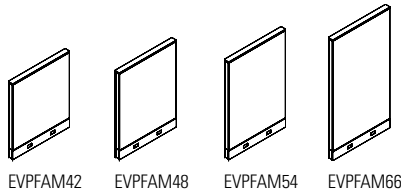

Monolithic Light Panel

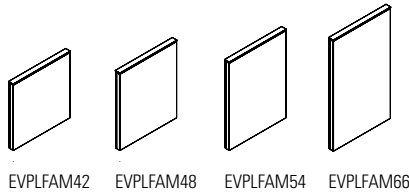

Monolithic Beltline Powered Panel

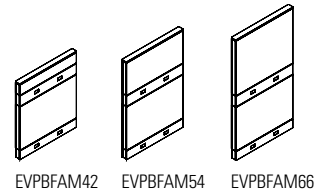

Monolithic Beltline Powered Light Panel

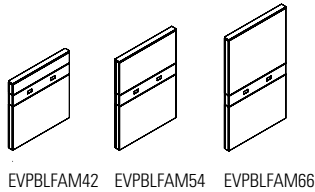

Monolithic Beltline Powered Chimney Panel

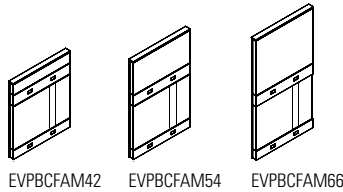

Chimney Jumper Cable Kit

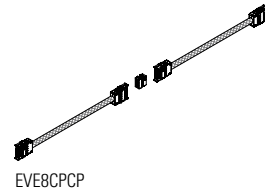

Monolithic Beltline Non-Powered Panel

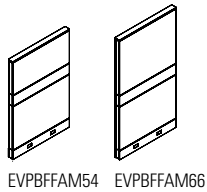

Monolithic Beltline Non-Powered Light Panel

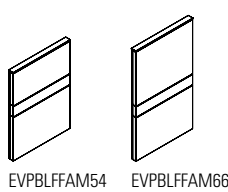

SEGMENTED PANELS - PAGES 28-33

Segmented Panel

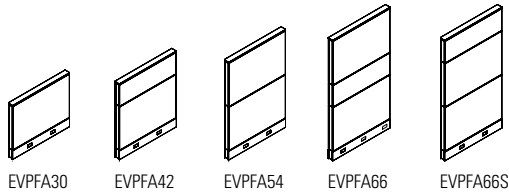

Segmented Light Panel

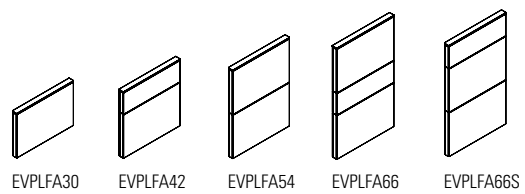

Segmented Premium Panel

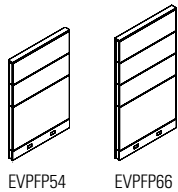

Segmented Premium Light Panel

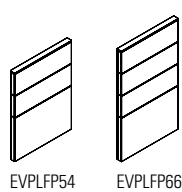

Segmented Beltline Powered Panel

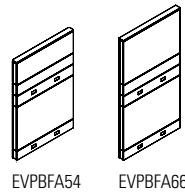

Segmented Beltline Powered Light Panel

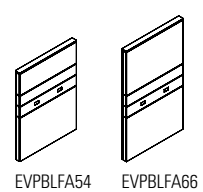

Segmented Beltline Powered Chimney Panel

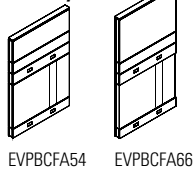

Chimney Jumper Cable Kit

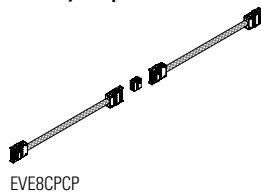

Segmented Beltline Non-Powered Panel

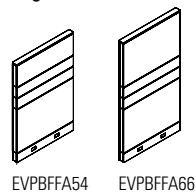

Segmented Beltline Non-Powered Light Panel

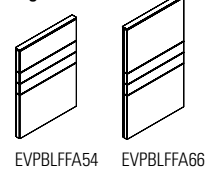

PARTLY GLAZED - TEMPERED GLASS PANELS - PAGES 34-43

Monolithic 12"H Glazed Panel

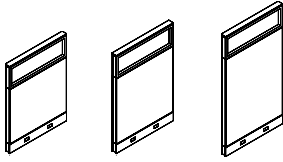

EVPMGTU48 EVPMGTU54 EVPMGTU66

Monolithic 12"H Glazed Light Panel

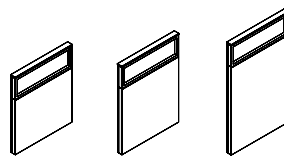

EVPLMGTU48 EVPLMGTU54 EVPLMGTU66

Segmented 12"H Glazed Panel

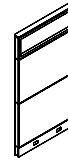

EVPPGTU66

Segmented 12"H Glazed Light Panel

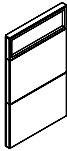

EVPLFGTU66

Segmented 12"H Glazed Premium Panel

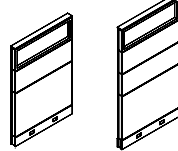

EVPPFGTU54 EVPPFGTU66

Segmented 12"H Glazed Premium Light Panel

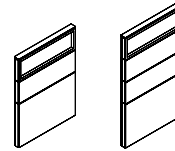

EVPLFPGTU54 EVPLFPGTU66

Partly Glazed Panel

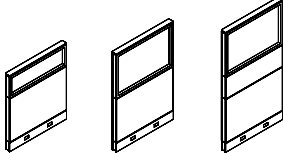

EVPPGT42 EVPPGT54 EVPPGT66

Partly Glazed Light Panel

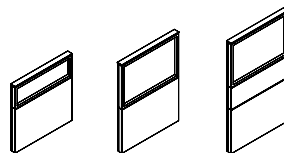

EVPLFGT42 EVPLFGT54 EVPLFGT66

Partly Glazed Panel - 36"H



EVPPGTX66

Partly Glazed Light Panel - 36"H



EVPLFGTX66

Partly Glazed Beltline Powered Panel

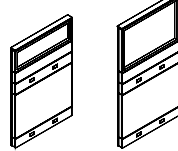

EVPPBFGT54 EVPPBFGT66

Partly Glazed Beltline Powered Light Panel

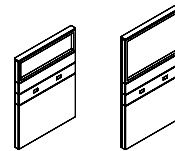

EVPPBLFGT54 EVPPBLFGT66

Partly Glazed Beltline Powered Chimney Panel

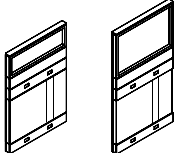

EVPPBCFGT54 EVPPBCFGT66

Chimney Jumper Cable Kit

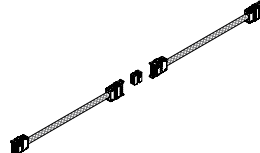

EVE8CPCP

Partly Glazed Premium Panel

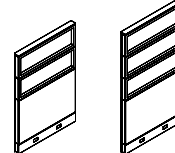

EVPPFGT54 EVPPFGT66

Partly Glazed Premium Light Panel

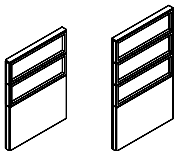

EVPLFPGT54 EVPLFPGT66

FULLY GLAZED - TEMPERED GLASS PANELS - PAGES 44-47

Fully Monolithic Panel

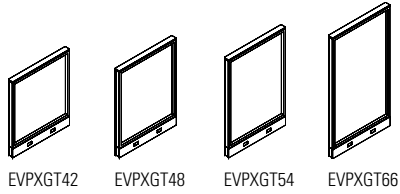

Fully Monolithic Light Panel

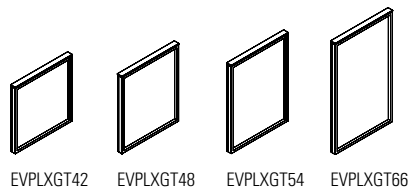

Fully Glazed Segmented Panel



Fully Glazed Segmented Light Panel

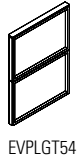

Fully Glazed Premium Panel

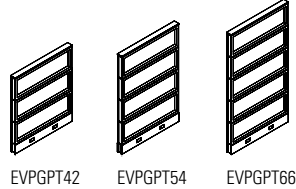

Fully Glazed Premium Light Panel

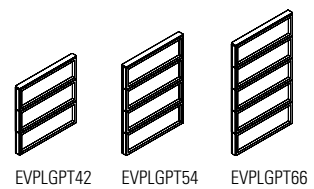

PASS-THRU SLIDING DOOR - PAGES 50-51

Pass-Thru Sliding Door Glazed Panel

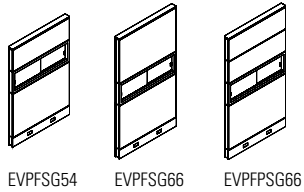

Fabric Glazed Pass-Thru Sliding Door Panel

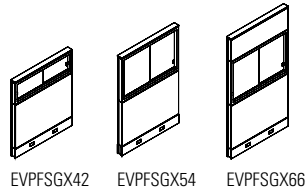

SLATWALL PANELS - PAGES 52-58

Slatwall Panel - Single Sided

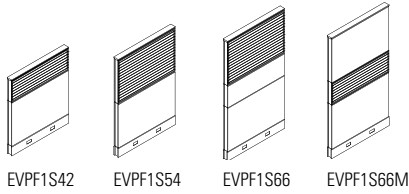

Slatwall Light Panel - Single Sided

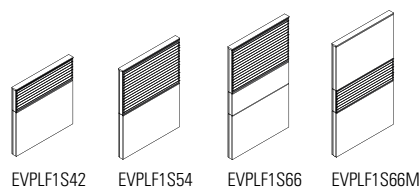

Slatwall Panel - Double Sided

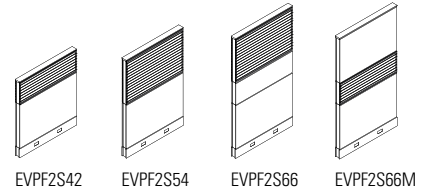

Slatwall Light Panel - Double Sided

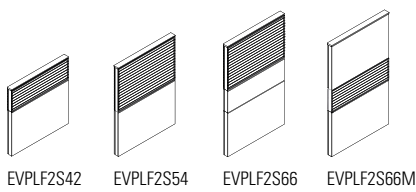

Frameless Slatwall Panel - Double Sided

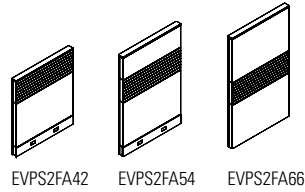

Frameless Slatwall Beltline Powered Panel - DS

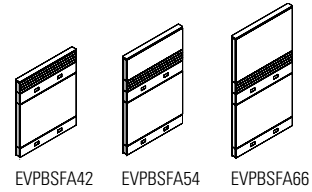

Frameless Slatwall Beltline Powered Light Panel - DS

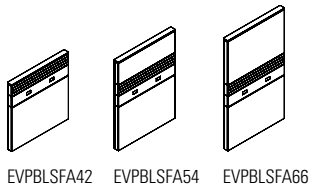

Frameless Slatwall Beltline Powered Chimney Panel - Double Sided

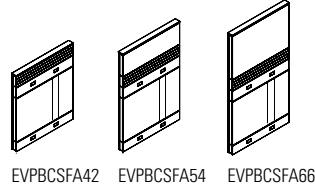

Chimney Jumper Cable Kit

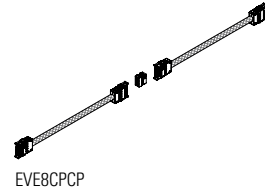

WRITE BOARD PANELS - PAGES 59-60

Write Board Panel - Single Sided

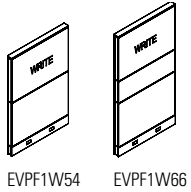

Write Board Light Panel - Single Sided

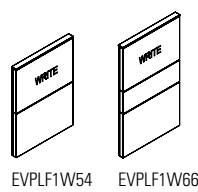

Write Board Panel - Double Sided

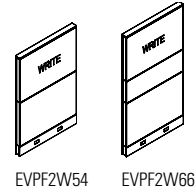

Write Board Light Panel - Double Sided

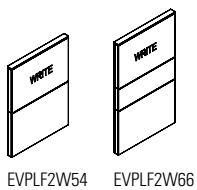

LAMINATE PANELS - PAGES 61-64

Laminate Panel - Single Sided

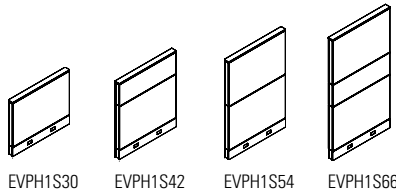

Laminate Light Panel - Single Sided

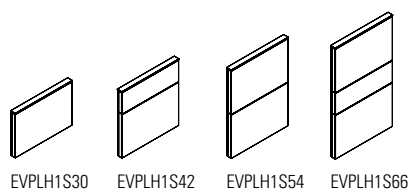

Laminate Panel - Double Sided

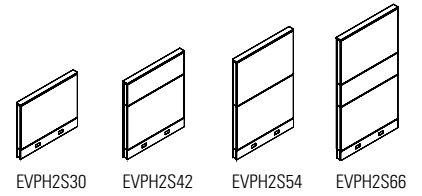

Laminate Light Panel - Double Sided

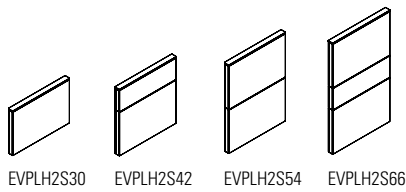

AIRFLOW PANELS - PAGES 65-68

Airflow Panel

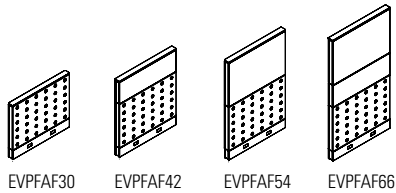

Airflow Light Panel

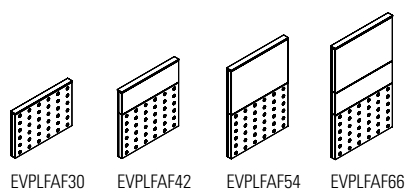

Airflow Premium Panel

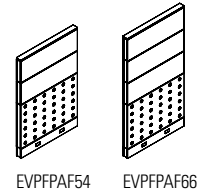

Airflow Premium Light Panel

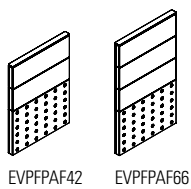

Airflow Middle Premium Light Panel

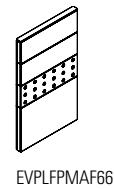

METAL SKIN PANELS - PAGES 69-72

Metal Skin Panel - Single Sided

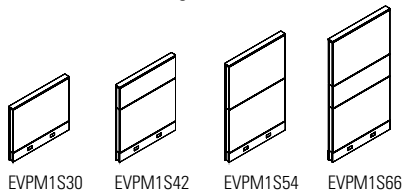

Metal Skin Light Panel - Single Sided

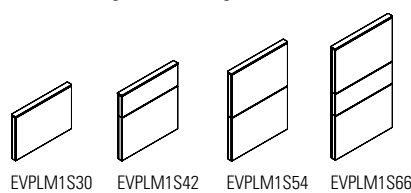

Metal Skin Panel - Double Sided

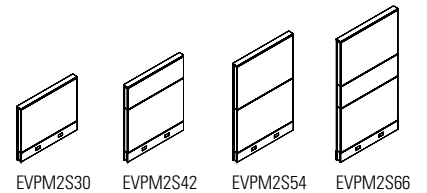

Metal Skin Light Panel - Double Sided

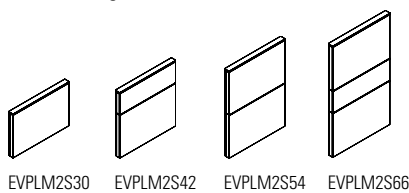

OPEN PANELS - PAGES 73-78

Open Bottom Panel

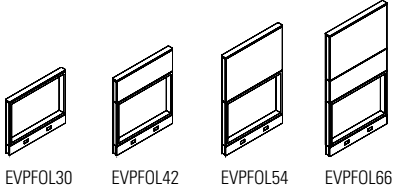

EVPFOL30 EVPFOL42 EVPFOL54 EVPFOL66

Open Bottom Light Panel

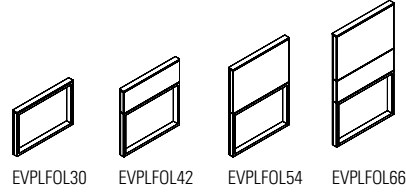

EVPLFOL30 EVPLFOL42 EVPLFOL54 EVPLFOL66

Open Bottom Premium Panel

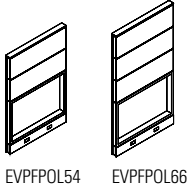

EVFPOL54 EVFPOL66

Open Bottom Premium Light Panel

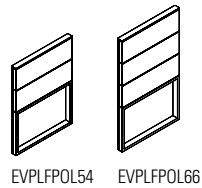

EVPLPOL54 EVPLPOL66

Open Middle Panel - 12"H Opening

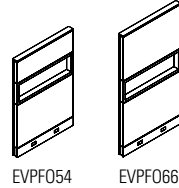

EVPF054 EVPF066

Open Middle Light Panel - 12"H Opening

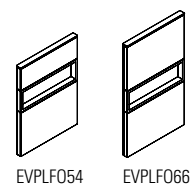

EVPLF054 EVPLF066

Open Middle Premium Panel - 12"H Opening

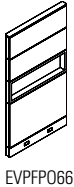

EVFP066

Open Middle Premium Light Panel - 12"H Opening

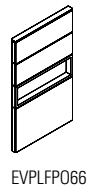

EVPLF066

Open Middle Panel - 24"H Opening

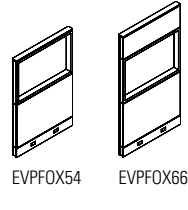

EVPF0X54 EVPF0X66

Open Middle Light Panel - 24"H Opening

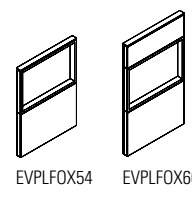

EVPLF0X54 EVPLF0X66

NO RACEWAY PANELS - PAGES 79-91

Segmented

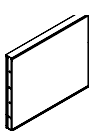

EVFA3018NR

Monolithic

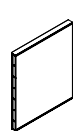

EVFAM4218NR

Laminate - Single Sided

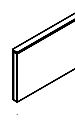

EVPH1S3018NR

Laminate - Double Sided

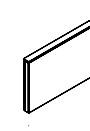

EVPH2S3018NR

Fully Glazed Monolithic

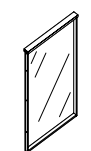

EVXGT9018NR

Inline Connector

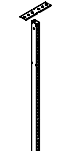

EVPIC30NR

End of Run

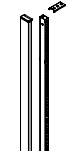

EVPERA30NR

Corner Post - One Way

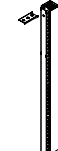

EVPCPA130NR

Inline Corner Post - Two Way

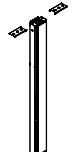

EVPIPA230NR

Corner Post - Two Way

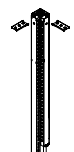

EVPCPA230PNR

Corner Post - Three Way



EVPCPA330PNR

Corner Post - Four Way

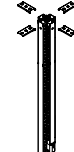

EVPCPA430PNR

GALLERY PANELS - PAGES 92-105

**Laminate Double Sided Finished Ends**



EVLEPDS4251NC

**Laminate Double Sided Connector Ends**



EVLEPDS4251

**Laminate Single Sided Finished Ends**



EVLEPSSL4227NC

**Laminate Double Sided Beltline Connector Ends**



EVLEPSSL4227

**Laminate Double Sided Middle Base Power, Finished Ends**



EVLEPDC4251NC

**Laminate Double Sided Middle Beltline Power, Finished Ends**



EVICLXP4251NC

**Laminate Double Sided Base Power, Connector Ends**



EVLEPDC4251

**Laminate Double Sided Middle Beltline Power, Connector Ends**



EVICLXP4251

**Laminate Single Sided Middle Base Power, Finished Ends**



EVLEPSC4227NC

**Laminate Single Sided Middle Base Power, Connector End**



EVLEPSC4227

**Laminate Single Sided Middle Beltline Power, Finished Ends**



EVLEPSCB4227NC

**Laminate Single Sided Middle Beltline Power, Connector End**



EVLEPSCB4227

**Laminate Gallery Extension Finished End**



EVLXPML4224NC

**Laminate Gallery Straight Extension, Connector Ends**



EVLXPML4224

**Laminate Gallery Two-Way Extension, Finished Ends**



EV2LXPL4225

**Laminate Gallery Three-Way Extension, Finished Ends**



EV3LXPL4249

**Laminate Double Gallery for Four-Way, Finished Ends**



EV4LXP4249

**Laminate Extension Panel for Four-Way, Finished Ends**



EV4LXPM4224

**Panel Connector with U Channel**

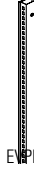

EVPERCH42

**Panel Connector w/U Channel For Beltline Panels**



EVPPERCH42

**Laminate Gallery Panel Bottom Bracket**



EVHLPBB01

**Laminate Gallery Panel Corner Bracket**



EVHLPBB01

**Connector w/U Channel Top Trim Aluminum**



EVPTTAU24

1" LAMINATE PANELS - PAGES 106-108

1" Laminate End Panel

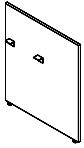

EVLEPR42

1" Laminate Middle Panel

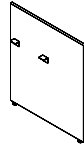

EVLMP42

1" Laminate End Panel w/ Accessory Rail

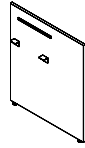

EVLEPR42A

1" Laminate Middle Panel w/ Accessory Rail



EVLMP42A

Double Inline Panel Connector

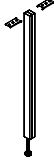

EVPDIC42

Beltline Doubleinline Panel Connector

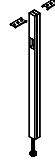

EVBDIC42

Double Inline Connector Trim

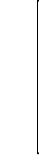

EVPDVTF42

Double Inline Panel Connector Top Trim - Aluminum

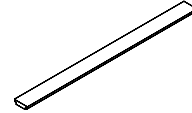

EVPTTA25

DOOR PANELS - PAGES 110-112

Door Panel - Solid

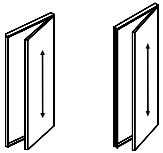

EVPS84

EVPS90

Knob Lock Set

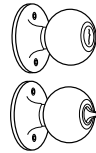

EVPSL01

Lever Lock Set



EVPSL02

Sliding Door Lock

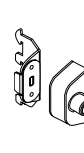

EVPSLLOCK

Sliding Door

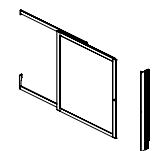

EVDPDS

Mini Panel Kit

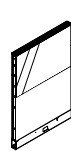

EVMPK02

Low Profile Foot

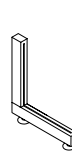

EVHLPF01

PRIVACY PANELS - PAGES 149-164

Glazed Monolithic Privacy Panel



EVPPXGTF4218

Ribbed Monolithic Privacy Panel



EVPPXGR4218

EVPPXGR4218M

EVPPXGRF4218

78" Glazed Monolithic Privacy Panel



EVPPXGT7824

EVPPXGT7824M

EVPPXGTF7824

Glazed Privacy Panel



EVPPGT5424

EVPPGT5424M

Glazed Privacy Panel

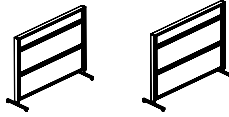

EVPPGT6624

EVPPGT6624M

Laminate Glazed Privacy Panel



EVPPHGTU5424

EVPPHGTU5424M

Laminate Glazed Privacy Panel



EVPPHGT5424

EVPPHGT6624M

Laminate Privacy Panel

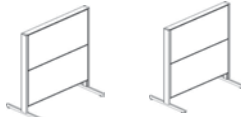

EVPPH2S5424

EVPPH2S5424M

Write Board Glazed Privacy Panel

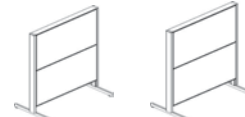

EVPPF2W5424

EVPPF2W5424M

Write Board Laminate Privacy Panel

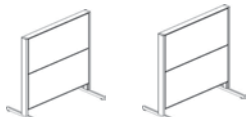

EVPPH2W5424

EVPPH2W5424M

This page provides an exploded view of a sample configuration highlighting each **Panel** component required when specifying this configuration.

**Components**

- A.** EVPERA66 End-of-Run Kit (Wall mount)  
Note: adds 1" to the width of a Panel Run.
- B.** EVPFA6636 Segmented Panel
- C.** EVPIC66 Inline Panel Connector
- D.** EVPCPA266 Two-Way Corner Post  
Note: Trim kit included.  
Post Connectors can be custom manufactured with or without slots. Contact your Evolve Customer Support Representative for a special quote.
- E.** EVPVC66 Variable-Height Connector  
Note: Connector height must reference taller Panel.
- F.** EVPTVA24 Panel Trim Variable-Height
- G.** EVPFA4236 Segmented Panel

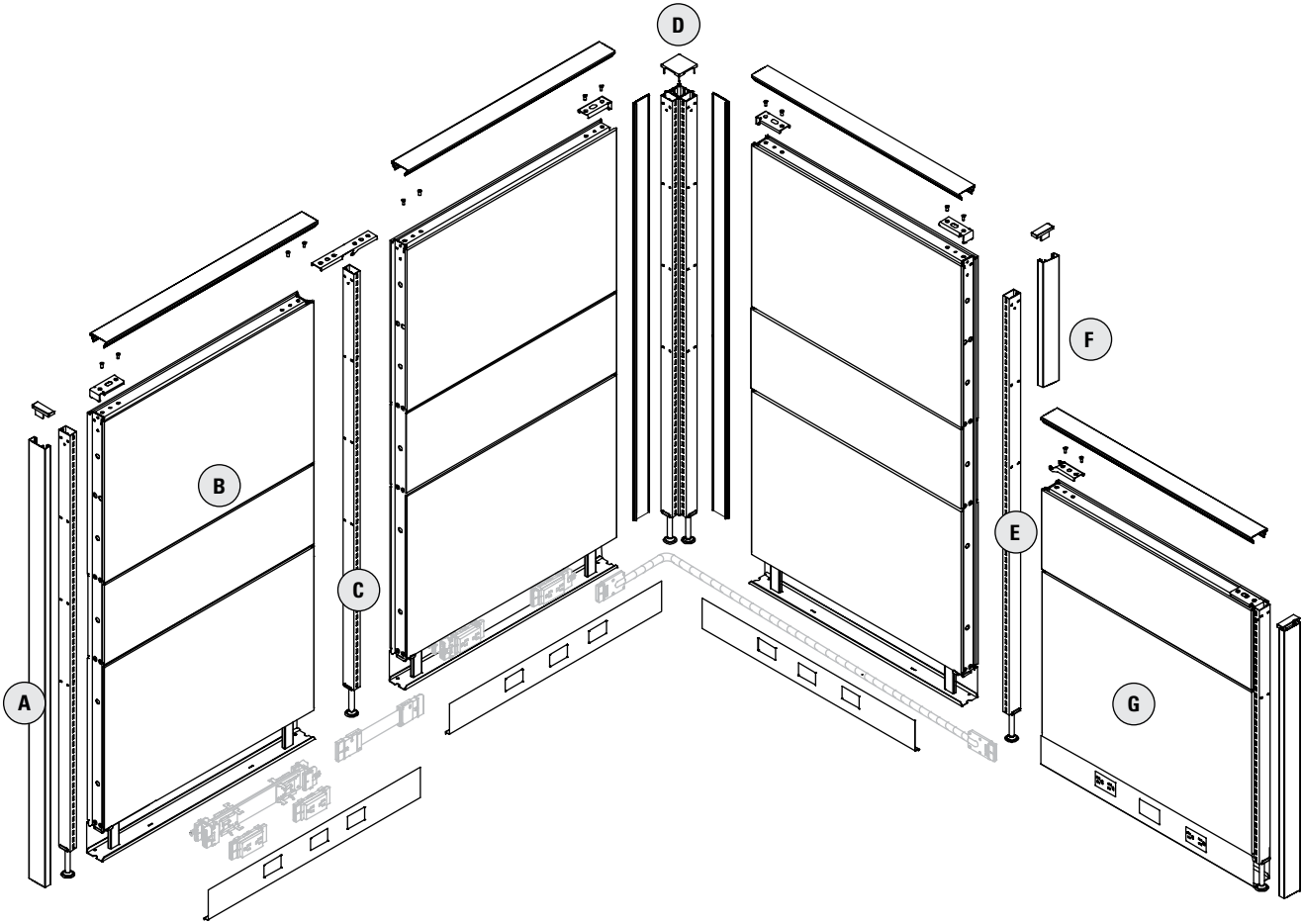

This page provides an exploded view of a sample configuration highlighting each **Beltline Power Panel** component required when specifying this configuration.

**Components**

- |   |   |
|---|---|
| <p><b>A.</b> EVPERA66 End-of-Run Kit (Wall mount)<br/>Note: adds 1" to the width of a Panel Run.</p> <p><b>B.</b> EVPBCFAM6636 Monolithic Beltline Powered Chimney Panel</p> <p><b>C.</b> EVPBIC66 Inline Panel Connector for Beltline Electric Panels</p> <p><b>D.</b> EVPBIPA266 Two-Way Corner Post for Beltline Electric Panels<br/>Note: Trim kit included.<br/>Post Connectors can be custom manufactured with or without slots. Contact your Evolve Customer Support Representative for a special quote.<br/>Note: All beltline post connectors come with PVC covers to install at beltline height on all sides.</p> | <p><b>E.</b> EVPVC66 Variable-Height Connector for Beltline Electric Panels<br/>Note: Connector height must reference taller Panel.</p> <p><b>F.</b> EVPTEA24 Panel Extension Trim</p> <p><b>G.</b> EVPBFAM4236 Monolithic Beltline Powered Panel</p> |
|---|---|

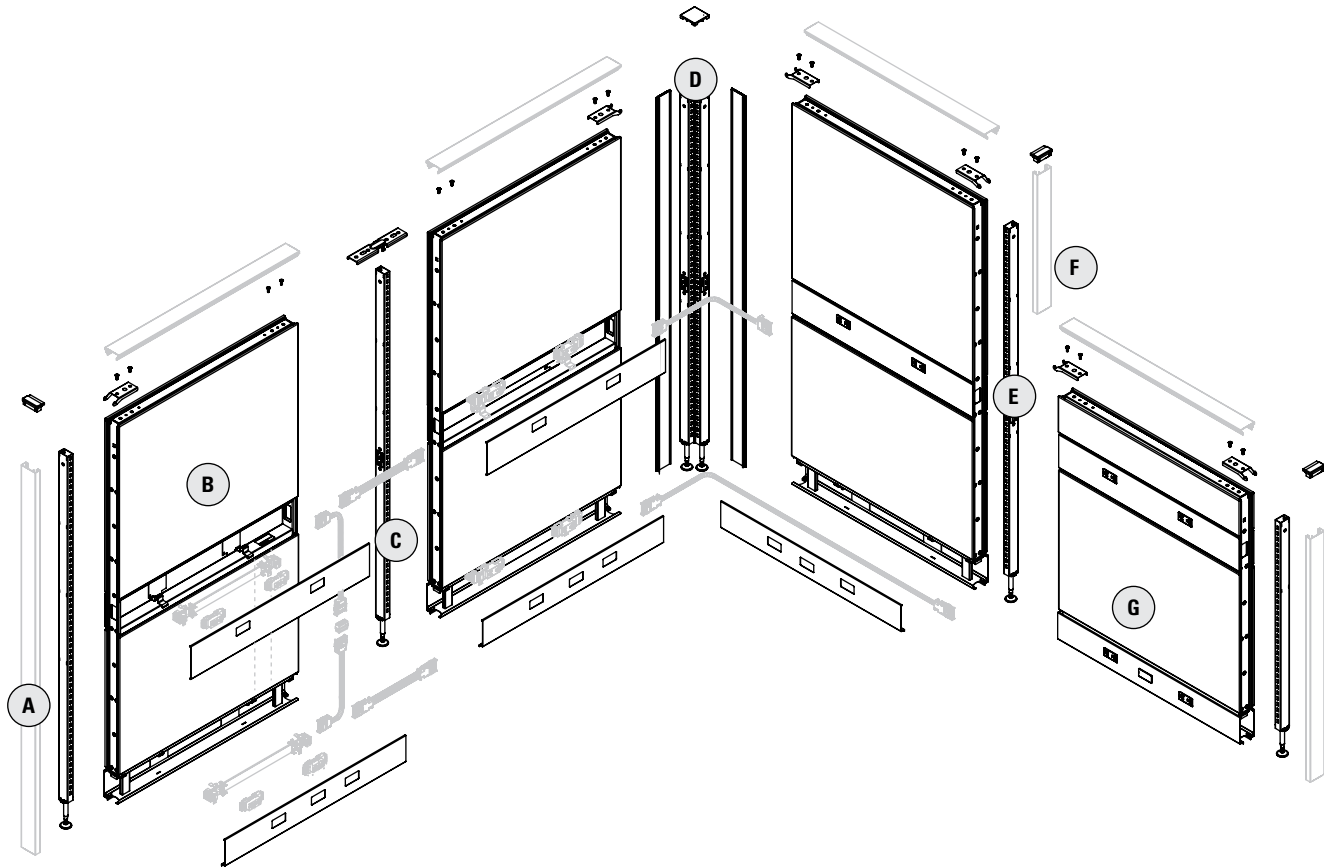

## **EACH ORDER MUST INCLUDE:**

- Purchase Order
- Layout showing where the image(s) appear in the run of panels.
- A completed Price Chart, showing the location of the image(s) on each appropriate panel.
- Artwork must be submitted in accordance with the following artwork specifications.
- NOTE: Final artwork specification approval must be given before order can be processed.

## **TRANSFER DEVICES**

- Email up to 10MB to your Evolve Customer Service Representative.
- Courier CD/DVD/USB drive to your Evolve Customer Service Representative.

## **ARTWORK SPECIFICATIONS**

- Non-Photographic artwork should be vector art. Saved in Adobe Illustrator (.ai) or as an EPS (.eps)
- All bitmap or photographic artwork has to be at a minimum of 100 dpi at the full size of the panel to be printed.
- We accept Adobe CS5 files.
- Any linked files must be included or imbedded.
- Leave any PSD files un-flattened
- All fonts must be converted to outlines.
- Do not convert to CMYK, leave all images as RGB if possible
- No Word, Powerpoint, Publisher or other Microsoft files can be used.
- Include a PDF or .jpg for reference when sending native Photoshop or Illustrator format files.

## **COLOR MATCHING**

- A Pantone color reference must be supplied or we cannot accept responsibility for correct color or color correction.
- When it is not possible to refer to Pantone colors, we will do our best to meet your requirements.

## **IMAGE CLARITY**

- We will advise should the selected image not lend itself to the element size requested.

## **NOTE:**

- We reserve the right to put an order on hold when the files are found to be incomplete or when documents have been either incorrectly saved, fonts have not been converted to curves or the job appears not to be commercially acceptable.

## **IMAGE BLEED:**

- To facilitate placement on the panel. Extension of the image past the finished visible area of the panel (bleed) is required.
- Evolve Panels need a 3.5" bleed on all sides

**EXAMPLE OF IMAGE RESOLUTION:**

- The resolution required for a 36 wide x 24 high Evolve panel at 100dpi (minimum resolution)

The resolution required for a 36 wide x 24 high Evolve panel at 300dpi (higher quality)

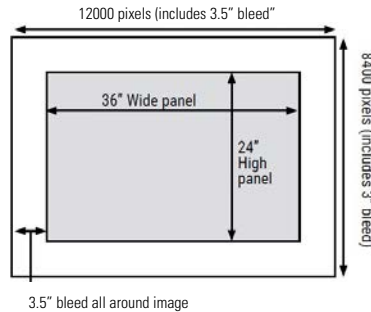
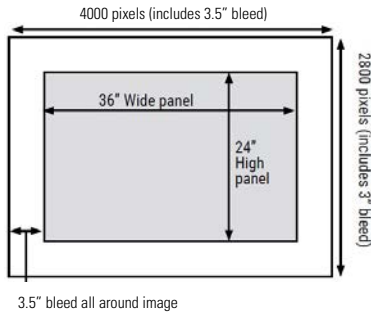

**EVOLVE SYSTEMS - GRAPHIC PANEL EXAMPLE PROCEDURE**

**STEP 1:** Customer orders the following EVPFA6636 panel with;

- Bottom module inside face (24/36 size fabric) with image 01.
- Middle module inside face (12/36 size fabric) with image 02.
- All other fabric material is regular fabric - top module inside face and all outside module faces.

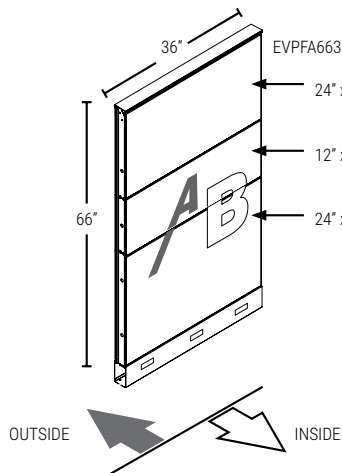

**Note: To order, please use graphic codes below**

- (A)  
EVPGRP1236
- (B)  
EVPGRP2436

**STEP 2:** On the regular panel - replace fabric pieces with corresponding graphic pieces.

**STEP 3:** On the regular panel - replace fabric pieces with corresponding graphic pieces.

- EVPGRP1236 for the middle module inside face
- EVPGRP2436 for the bottom module inside face

**EVGGRP - 6”H GRAPHIC FABRIC FACTORY INSTALLED**

- Graphic fabric for one side of 6” module.
- Graphic fabric to be installed at factory at specified 6” H module of fabric panel
- Fabric panel not included. Prices shown are an upcharge to the applicable panel price. Please add the upcharge to the list price of the panel on which you are specifying a graphic.
- Applies to the following panels: EVPFA, EVFPF, EVPF1W, EVPF2W, EVPF1S, EVPF2S, EVPFGT, EVFPFGTU, EVPFOL, EVFPFOL, EVPFO, EVFPFO, EVPFE, EVFPFE
- Note: initial set up charge is \$250 net per image

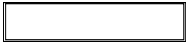
	DESCRIPTION	PRODUCT CODE	LIST PRICE	DIMENSIONS/INCHES		
				H	W	D
	Graphic fabric for 6” Module	EVGGRP0624	171	6	24	
		EVGGRP0630	214	6	30	
		EVGGRP0636	257	6	36	
		EVGGRP0642	299	6	42	
		EVGGRP0648	342	6	48	
		EVGGRP0654	388	6	54	
		EVGGRP0660	432	6	60	

**EVGGRP - 12”H GRAPHIC FABRIC FACTORY INSTALLED**

- Graphic fabric for one side of 12” module.
- Graphic fabric to be installed at factory at specified 12” H module of fabric panel
- Fabric panel not included. Prices shown are an upcharge to the applicable panel price. Please add the upcharge to the list price of the panel on which you are specifying a graphic.
- Applies to the following panels: EVPFA, EVFPF, EVPF1W, EVPF2W, EVPF1S, EVPF2S, EVPFGT, EVFPFGTU, EVPFOL, EVFPFOL, EVPFO, EVFPFO, EVPFE, EVFPFE
- Note: initial set up charge is \$250 net per image

	DESCRIPTION	PRODUCT CODE	LIST PRICE	DIMENSIONS/INCHES		
				H	W	D
	Graphic fabric for 12” Module	EVGGRP1224	171	12	24	
		EVGGRP1230	214	12	30	
		EVGGRP1236	257	12	36	
		EVGGRP1242	299	12	42	
		EVGGRP1248	342	12	48	
		EVGGRP1254	388	12	54	
		EVGGRP1260	432	12	60	

**EVGGRP - 18”H GRAPHIC FABRIC FACTORY INSTALLED**

- Graphic fabric for one side of 18” module.
- Graphic fabric to be installed at factory at specified 18” H module of fabric panel
- Fabric panel not included. Prices shown are an upcharge to the applicable panel price. Please add the upcharge to the list price of the panel on which you are specifying a graphic.
- Applies to the following panels: EVPFA, EVFPF, EVPF1W, EVPF2W, EVPF1S, EVPF2S, EVPFGT, EVFPFGTU, EVPFOL, EVFPFOL, EVPFO, EVFPFO, EVPFE, EVFPFE
- Note: initial set up charge is \$250 net per image

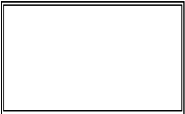
	DESCRIPTION	PRODUCT CODE	LIST PRICE	DIMENSIONS/INCHES		
				H	W	D
	Graphic fabric for 18” Module	EVGGRP1824	336	18	24	
		EVGGRP1830	422	18	30	
		EVGGRP1836	510	18	36	
		EVGGRP1842	598	18	42	
		EVGGRP1848	683	18	48	
		EVGGRP1854	769	18	54	
		EVGGRP1860	858	18	60	

**EVPGRP - 24”H GRAPHIC FABRIC FACTORY INSTALLED**

- Graphic fabric for one side of 24” module.
- Graphic fabric to be installed at factory at specified 24” H module of fabric panel
- Fabric panel not included. Prices shown are an upcharge to the applicable panel price. Please add the upcharge to the list price of the panel on which you are specifying a graphic.
- Applies to the following panels: EVPFA, EVFPF, EVPF1W, EVPF2W, EVPF1S, EVPF2S, EVPFGT, EVFPFGTU, EVPFOL, EVFPFOL, EVPFO, EVFPFO, EVPFE, EVFPFE
- Note: initial set up charge is \$250 net per image

DESCRIPTION	PRODUCT CODE	LIST PRICE	DIMENSIONS/INCHES		
			H	W	D
 <p>Graphic fabric for 24” Module</p>	EVPGRP2424	336	24	24	
	EVPGRP2430	422	24	30	
	EVPGRP2436	510	24	36	
	EVPGRP2442	598	24	42	
	EVPGRP2448	683	24	48	
	EVPGRP2454	769	24	54	
	EVPGRP2460	858	24	60	

**EVPGRP - 36”H GRAPHIC FABRIC FACTORY INSTALLED**

- Graphic fabric for one side of 36” module (42” panel)
- Graphic fabric to be installed at factory on monolithic module
- Fabric panel not included. Prices shown are an upcharge to the applicable panel price. Please add the upcharge to the list price of the panel on which you are specifying a graphic.
- Applies to the following panels: EVPFAM
- Note: initial set up charge is \$250 net per image

DESCRIPTION	PRODUCT CODE	LIST PRICE	DIMENSIONS/INCHES		
			H	W	D
 <p>Graphic fabric for 36” Monolithic Module</p>	EVPGRP3624	510	36	24	
	EVPGRP3630	656	36	30	
	EVPGRP3636	785	36	36	
	EVPGRP3642	914	36	42	
	EVPGRP3648	1044	36	48	
	EVPGRP3654	1176	36	54	
	EVPGRP3660	1306	36	60	

**EVPGRP - 42”H GRAPHIC FABRIC FACTORY INSTALLED**

- Graphic fabric for one side of 42” module (48” panel)
- Graphic fabric to be installed at factory on monolithic module
- Fabric panel not included. Prices shown are an upcharge to the applicable panel price. Please add the upcharge to the list price of the panel on which you are specifying a graphic.
- Applies to the following panels: EVPFAM
- Note: initial set up charge is \$250 net per image

DESCRIPTION	PRODUCT CODE	LIST PRICE	DIMENSIONS/INCHES		
			H	W	D
 <p>Graphic fabric for 42” Monolithic Module</p>	EVPGRP4224	599	42	24	
	EVPGRP4230	762	42	30	
	EVPGRP4236	914	42	36	
	EVPGRP4242	1067	42	42	
	EVPGRP4248	1221	42	48	
	EVPGRP4254	1371	42	54	
	EVPGRP4260	1524	42	60	

**EVPGRP - 48”H GRAPHIC FABRIC FACTORY INSTALLED**

- Graphic fabric for one side of 48” module (54” panel).
- Graphic fabric to be installed at factory on monolithic module
- Fabric panel not included. Prices shown are an upcharge to the applicable panel price. Please add the upcharge to the list price of the panel on which you are specifying a graphic.
- Applies to the following panels: EVPFAM
- Note: initial set up charge is \$250 net per image

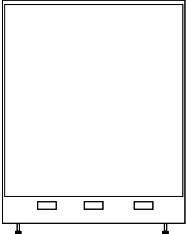
	DESCRIPTION	PRODUCT CODE	LIST PRICE	DIMENSIONS/INCHES		
				H	W	D
	Graphic fabric for 48” Monolithic Module	EVPGRP4824	681	48	24	
		EVPGRP4830	870	48	30	
		EVPGRP4836	975	48	36	
		EVPGRP4842	1221	48	42	
		EVPGRP4848	1394	48	48	
		EVPGRP4854	1569	48	54	
		EVPGRP4860	1741	48	60	

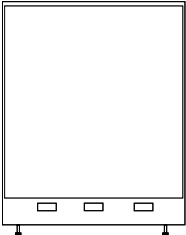

**EVPGRP - 60”H GRAPHIC FABRIC FACTORY INSTALLED**

- Graphic fabric for one side of 60” module (66” panel).
- Graphic fabric to be installed at factory on monolithic module
- Fabric panel not included. Prices shown are an upcharge to the applicable panel price. Please add the upcharge to the list price of the panel on which you are specifying a graphic.
- Applies to the following panels: EVPFAM
- Note: initial set up charge is \$250 net per image

	DESCRIPTION	PRODUCT CODE	LIST PRICE	DIMENSIONS/INCHES		
				H	W	D
	Graphic fabric for 60” Monolithic Module	EVPGRP6024	858	60	24	
		EVPGRP6030	1090	60	30	
		EVPGRP6036	1306	60	36	
		EVPGRP6042	1524	60	42	
		EVPGRP6048	1741	60	48	
		EVPGRP6054	1958	60	54	
		EVPGRP6060	2176	60	60	



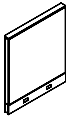

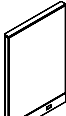
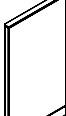
**EVPFAM - MONOLITHIC PANEL**

- Monolithic Panel incorporates fabric modules within a solid steel frame.
- Fabric covered modules are tackable and acoustical.
- Opposite sides of each panel may have a different fabric within the same grade at no upcharge.
- If different grades of fabric are used on one panel, the entire panel must be priced at highest grade.
- An aluminum low profile top cap is included.
- Stackability: Evolve panels can be increased in height in 6”H, 12”H, 18”H or 24”H increments. See Extension Modules for part numbers.

	DESCRIPTION	PRODUCT CODE	LIST PRICE		DIMENSIONS/INCHES		
			Gr1	Gr2	H	W	D
	Monolithic Panel - 42" High	EVPFAM4218	389	427	42	18	2 7/8
		EVPFAM4224	417	464	42	24	2 7/8
		EVPFAM4230	477	532	42	30	2 7/8
		EVPFAM4236	509	572	42	36	2 7/8
		EVPFAM4242	562	636	42	42	2 7/8
		EVPFAM4248	613	694	42	48	2 7/8
		EVPFAM4254	674	764	42	54	2 7/8
	Monolithic Panel - 48" High	EVPFAM4818	394	432	48	18	2 7/8
		EVPFAM4824	434	482	48	24	2 7/8
		EVPFAM4830	502	559	48	30	2 7/8
		EVPFAM4836	547	610	48	36	2 7/8
		EVPFAM4842	610	683	48	42	2 7/8
		EVPFAM4848	662	742	48	48	2 7/8
		EVPFAM4854	732	823	48	54	2 7/8
	Monolithic Panel - 54" High	EVPFAM5418	400	438	54	18	2 7/8
		EVPFAM5424	440	487	54	24	2 7/8
		EVPFAM5430	511	566	54	30	2 7/8
		EVPFAM5436	569	635	54	36	2 7/8
		EVPFAM5442	634	707	54	42	2 7/8
		EVPFAM5448	690	771	54	48	2 7/8
		EVPFAM5454	756	850	54	54	2 7/8
	Monolithic Panel - 66" High	EVPFAM6618	493	531	66	18	2 7/8
		EVPFAM6624	540	588	66	24	2 7/8
		EVPFAM6630	610	668	66	30	2 7/8
		EVPFAM6636	711	774	66	36	2 7/8
		EVPFAM6642	796	869	66	42	2 7/8
		EVPFAM6648	863	942	66	48	2 7/8
		EVPFAM6654	959	1047	66	54	2 7/8
EVPFAM6660	1052	1149	66	60	2 7/8		

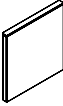
**EVPLFAM - MONOLITHIC LIGHT PANEL**

- Monolithic Light Panel incorporates fabric modules within a solid steel frame.
- There is no base raceway in Light Panels to accommodate electrical.
- Light Panel Connectors must be used in conjunction with Light Panels.
- Fabric covered modules are tackable and acoustical.
- Opposite sides of each panel may have a different fabric within the same grade at no upcharge.
- If different grades of fabric are used on one panel, the entire panel must be priced at highest grade.
- An aluminum low profile top cap is included.
- Stackability: Evolve Light panels can be increased in height in 6”H, 12”H, 18”H or 24”H increments. See Extension Modules for part numbers.

	DESCRIPTION	PRODUCT CODE	LIST PRICE		DIMENSIONS/INCHES		
			Gr1	Gr2	H	W	D
	Monolithic Light Panel - 42" High	EVPLFAM4218	374	410	42	18	2 7/8
		EVPLFAM4224	393	440	42	24	2 7/8
		EVPLFAM4230	452	507	42	30	2 7/8
		EVPLFAM4236	483	546	42	36	2 7/8
		EVPLFAM4242	537	606	42	42	2 7/8
		EVPLFAM4248	582	661	42	48	2 7/8
		EVPLFAM4254	640	722	42	54	2 7/8
	Monolithic Light Panel - 48" High	EVPLFAM4818	379	415	48	18	2 7/8
		EVPLFAM4824	412	459	48	24	2 7/8
		EVPLFAM4830	477	530	48	30	2 7/8
		EVPLFAM4836	518	577	48	36	2 7/8
		EVPLFAM4842	579	649	48	42	2 7/8
		EVPLFAM4848	630	705	48	48	2 7/8
		EVPLFAM4854	695	782	48	54	2 7/8
	Monolithic Light Panel - 54" High	EVPLFAM5418	380	416	54	18	2 7/8
		EVPLFAM5424	419	463	54	24	2 7/8
		EVPLFAM5430	486	541	54	30	2 7/8
		EVPLFAM5436	540	601	54	36	2 7/8
		EVPLFAM5442	601	671	54	42	2 7/8
		EVPLFAM5448	654	733	54	48	2 7/8
		EVPLFAM5454	718	808	54	54	2 7/8
	Monolithic Light Panel - 66" High	EVPLFAM6618	471	507	66	18	2 7/8
		EVPLFAM6624	513	560	66	24	2 7/8
		EVPLFAM6630	579	636	66	30	2 7/8
		EVPLFAM6636	674	737	66	36	2 7/8
		EVPLFAM6642	756	826	66	42	2 7/8
		EVPLFAM6648	820	895	66	48	2 7/8
		EVPLFAM6654	909	997	66	54	2 7/8
EVPLFAM6660	998	1093	66	60	2 7/8		

**EVPBFAM - MONOLITHIC BELTLINE POWERED PANEL**

- Monolithic Beltline Powered Panel incorporates fabric modules with a power beltline raceway, within a solid steel frame.
- 6”H power beltline raceway, to accommodate electrical, is metal with knockouts on both side.
- A Chimney Panel is required to run electric and data from the base to belt.
- Beltline Connectors must be used in conjunction with beltline panels.
- Fabric covered modules are tackable and acoustical.
- Opposite sides of each panel may have a different fabric within the same grade at no upcharge.
- If different grades of fabric are used on one panel, the entire panel must be priced at highest grade.
- An aluminum low profile top cap is included.
- Stackability: Evolve panels can be increased in height in 6”H, 12”H, 18”H or 24”H increments. See Extension Modules for part numbers.

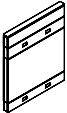
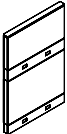
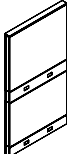
	DESCRIPTION	PRODUCT CODE	LIST PRICE		DIMENSIONS/INCHES		
			Gr1	Gr2	H	W	D
	Monolithic Beltline Powered Panel - 42” High 24” Fabric /6” Power Belt /6” Fabric	EVPBFAM4224	514	543	42	24	2 7/8
		EVPBFAM4230	607	641	42	30	2 7/8
		EVPBFAM4236	692	733	42	36	2 7/8
		EVPBFAM4242	779	826	42	42	2 7/8
		EVPBFAM4248	863	915	42	48	2 7/8
		EVPBFAM4254	944	1002	42	54	2 7/8
	Monolithic Beltline Powered Panel - 54” High 24” Fabric /6” Power Belt /18” Fabric	EVPBFAM5424	617	656	54	24	2 7/8
		EVPBFAM5430	724	771	54	30	2 7/8
		EVPBFAM5436	818	873	54	36	2 7/8
		EVPBFAM5442	917	978	54	42	2 7/8
		EVPBFAM5448	1007	1077	54	48	2 7/8
		EVPBFAM5454	1106	1181	54	54	2 7/8
	Monolithic Beltline Powered Panel - 66” High 24” Fabric /6” Power Belt /30” Fabric	EVPBFAM6624	730	800	66	24	2 7/8
		EVPBFAM6630	852	932	66	30	2 7/8
		EVPBFAM6636	963	1056	66	36	2 7/8
		EVPBFAM6642	1085	1191	66	42	2 7/8
		EVPBFAM6648	1198	1318	66	48	2 7/8
		EVPBFAM6654	1313	1445	66	54	2 7/8
		EVPBFAM6660	1429	1574	66	60	2 7/8

**EVPBLFAM - MONOLITHIC BELTLINE POWERED LIGHT PANEL**

- Monolithic Beltline Powered Light Panel incorporates fabric modules with a power beltline raceway within a solid steel frame
- 6”H power beltline raceway, to accommodate electrical, is metal with knockouts on both sides.
- There is no base raceway in Light Panels to accommodate electrical
- Light Beltline Panel Connectors must be used in conjunction with Light Beltline Panels.
- Fabric covered modules are tackable and acoustical.
- Opposite sides of each panel may have a different fabric within the same grade at no upcharge.
- If different grades of fabric are used on one panel, the entire panel must be priced at highest grade.
- An aluminum low profile top cap is included.
- Stackability: Evolve Light panels can be increased in height in 6”H, 12”H, 18”H or 24”H increments. See Extension Modules for part numbers.

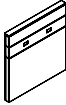
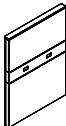
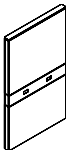
	DESCRIPTION	PRODUCT CODE	LIST PRICE		DIMENSIONS/INCHES		
			Gr1	Gr2	H	W	D
	Monolithic Beltline Powered Light Panel - 42” High 24” Fabric /6” Power Belt /6” Fabric	EVPBLFAM4224	488	517	42	24	2 7/8
		EVPBLFAM4230	577	611	42	30	2 7/8
		EVPBLFAM4236	656	697	42	36	2 7/8
		EVPBLFAM4242	739	786	42	42	2 7/8
		EVPBLFAM4248	820	870	42	48	2 7/8
		EVPBLFAM4254	898	956	42	54	2 7/8
		EVPBLFAM4260	976	1039	42	60	2 7/8
	Monolithic Beltline Powered Light Panel - 54” High 24” Fabric /6” Power Belt /18” Fabric	EVPBLFAM5424	569	610	54	24	2 7/8
		EVPBLFAM5430	666	714	54	30	2 7/8
		EVPBLFAM5436	752	807	54	36	2 7/8
		EVPBLFAM5442	840	903	54	42	2 7/8
		EVPBLFAM5448	928	998	54	48	2 7/8
		EVPBLFAM5454	1019	1094	54	54	2 7/8
		EVPBLFAM5460	1102	1184	54	60	2 7/8
	Monolithic Beltline Powered Light Panel - 66” High 24” Fabric /6” Power Belt /30” Fabric	EVPBLFAM6624	679	748	66	24	2 7/8
		EVPBLFAM6630	789	869	66	30	2 7/8
		EVPBLFAM6636	894	988	66	36	2 7/8
		EVPBLFAM6642	1007	1113	66	42	2 7/8
		EVPBLFAM6648	1113	1235	66	48	2 7/8
		EVPBLFAM6654	1221	1351	66	54	2 7/8
		EVPBLFAM6660	1328	1473	66	60	2 7/8

**EVPBCFAM - MONOLITHIC BELTLINE POWERED CHIMNEY PANEL**

- Monolithic Chimney Beltline Powered Panel incorporates fabric modules with a power beltline raceway within a solid steel frame.
- A Chimney Panel is required to run electric and data from the base to belt.
- Separate electric harness required to go from base to belt (see EVE8CPCP).
- 6”H power beltline raceway, to accommodate electrical, is metal with knockouts on both sides.
- Beltline Connectors must be used in conjunction with beltline panels.
- Fabric covered modules are tackable and acoustical.
- Opposite sides of each panel may have a different fabric within the same grade at no upcharge.
- If different grades of fabric are used on one panel, the entire panel must be priced at highest grade.
- An aluminum low profile top cap is included.
- Stackability: Evolve panels can be increased in height in 6”H, 12”H, 18”H or 24”H increments. See Extension Module listings for part numbers

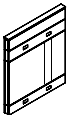
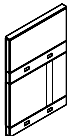
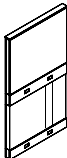
	DESCRIPTION	PRODUCT CODE	LIST PRICE		DIMENSIONS/INCHES		
			Gr1	Gr2	H	W	D
	Monolithic Beltline Powered Chimney Panel - 42” High 24” Fabric Chimney /6” Power Belt /6” Fabric	EVPBCFAM4236	777	818	42	36	2 7/8
		EVPBCFAM4242	865	912	42	42	2 7/8
	Monolithic Beltline Powered Chimney Panel - 54” High 24” Fabric Chimney /6” Power Belt /18” Fabric	EVPBCFAM5436	899	956	54	36	2 7/8
		EVPBCFAM5442	1001	1064	54	42	2 7/8
	Monolithic Beltline Powered Chimney Panel - 66” High 24” Fabric Chimney /6” Power Belt /30” Fabric	EVPBCFAM6636	1047	1141	66	36	2 7/8
		EVPBCFAM6642	1170	1276	66	42	2 7/8

**EVE8CPCP - CHIMNEY PANEL JUMPER CABLE KIT**

- Contains two (2) 17” flexible harnesses and one (1) “I” connector.
- Used to connect electric from the base to the beltline raceway in Beltline Powered Chimney panel.
- Must use in conjunction with base power distribution harness and beltline power distribution harness (sold separately)

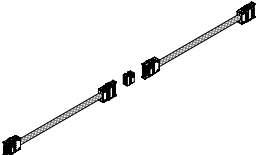
	DESCRIPTION	PRODUCT CODE	LIST PRICE	DIMENSIONS/INCHES		
				H	W	D
	Chimney Panel Jumper Cable Kit	EVE8CPCP	365			

**EVPBFFAM - MONOLITHIC BELTLINE NON-POWERED PANEL**

- Monolithic Beltline Non-Powered Panel incorporates fabric modules within a solid steel frame.
- Electrical cannot pass through panel at the beltline level.
- Fabric covered modules are tackable and acoustical.
- Opposite sides of each panel may have a different fabric within the same grade at no upcharge.
- If different grades of fabric are used on one panel, the entire panel must be priced at highest grade.
- An aluminum low profile top cap is included.
- Stackability: Evolve panels can be increased in height in 6”H, 12”H, 18”H or 24”H increments. See Extension Modules for part numbers.

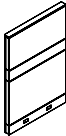
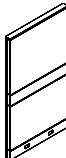
	DESCRIPTION	PRODUCT CODE	LIST PRICE		DIMENSIONS/INCHES		
			Gr1	Gr2	H	W	D
	Monolithic Beltline Non-Powered Panel - 54” High	EVPBFFAM5424	617	661	54	24	2 7/8
	24” Fabric /6” Fabric /18” Fabric	EVPBFFAM5430	724	777	54	30	2 7/8
		EVPBFFAM5436	818	879	54	36	2 7/8
		EVPBFFAM5442	917	987	54	42	2 7/8
		EVPBFFAM5448	1007	1087	54	48	2 7/8
		EVPBFFAM5454	1106	1196	54	54	2 7/8
		EVPBFFAM5460	1199	1296	54	60	2 7/8
	Monolithic Beltline Non-Powered Panel - 66” High	EVPBFFAM6624	730	801	66	24	2 7/8
	24” Fabric /6” Fabric /30” Fabric	EVPBFFAM6630	852	939	66	30	2 7/8
		EVPBFFAM6636	963	1062	66	36	2 7/8
		EVPBFFAM6642	1085	1201	66	42	2 7/8
		EVPBFFAM6648	1198	1326	66	48	2 7/8
		EVPBFFAM6654	1313	1453	66	54	2 7/8
		EVPBFFAM6660	1429	1587	66	60	2 7/8

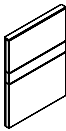
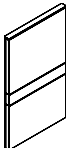

**EVPBLFFAM - MONOLITHIC BELTLINE NON-POWERED LIGHT PANEL**

- Monolithic Beltline Non-Powered Light Panel incorporates all fabric modules within a solid steel frame.
- There is no base raceway in Light Panels to accommodate electrical.
- Electrical cannot pass through panel at the beltline level.
- Fabric covered modules are tackable and acoustical.
- Opposite sides of each panel may have a different fabric within the same grade at no upcharge.
- If different grades of fabric are used on one panel, the entire panel must be priced at highest grade.
- An aluminum low profile top cap is included.
- Stackability: Evolve panels can be increased in height in 6”H, 12”H, 18”H or 24”H increments. See Extension Modules for part numbers.

	DESCRIPTION	PRODUCT CODE	LIST PRICE		DIMENSIONS/INCHES		
			Gr1	Gr2	H	W	D
	Monolithic Beltline Non-Powered Light Panel - 54” High	EVPBLFFAM5424	569	616	54	24	2 7/8
	24” Fabric /6” Fabric /18” Fabric	EVPBLFFAM5430	669	724	54	30	2 7/8
		EVPBLFFAM5436	752	813	54	36	2 7/8
		EVPBLFFAM5442	840	910	54	42	2 7/8
		EVPBLFFAM5448	928	1007	54	48	2 7/8
		EVPBLFFAM5454	1019	1107	54	54	2 7/8
		EVPBLFFAM5460	1102	1199	54	60	2 7/8
	Monolithic Beltline Non-Powered Light Panel - 66” High	EVPBLFFAM6624	679	750	66	24	2 7/8
	24” Fabric /6” Fabric /30” Fabric	EVPBLFFAM6630	789	876	66	30	2 7/8
		EVPBLFFAM6636	894	993	66	36	2 7/8
		EVPBLFFAM6642	1007	1124	66	42	2 7/8
		EVPBLFFAM6648	1113	1242	66	48	2 7/8
		EVPBLFFAM6654	1221	1361	66	54	2 7/8
		EVPBLFFAM6660	1328	1486	66	60	2 7/8

**EVPFA - SEGMENTED PANEL**

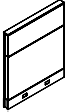
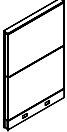
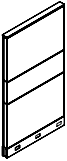
- Segmented Panel incorporates fabric modules within a solid steel frame.
- Fabric covered modules are tackable and acoustical.
- Opposite sides of each panel may have a different fabric within the same grade at no upcharge.
- If different grades of fabric are used on one panel, the entire panel must be priced at highest grade.
- An aluminum low profile top cap is included.
- Stackability: Evolve panels can be increased in height in 6”H, 12”H, 18”H or 24”H increments. See Extension Modules or part numbers.

	DESCRIPTION	PRODUCT CODE	LIST PRICE		DIMENSIONS/INCHES		
			Gr1	Gr2	H	W	D
	Segmented Panel - 30" High	EVPPFA3018	380	398	30	18	2 7/8
		EVPPFA3024	393	420	30	24	2 7/8
		EVPPFA3030	440	467	30	30	2 7/8
		EVPPFA3036	476	506	30	36	2 7/8
		EVPPFA3042	509	547	30	42	2 7/8
		EVPPFA3048	561	602	30	48	2 7/8
		EVPPFA3054	606	650	30	54	2 7/8
		EVPPFA3060	650	700	30	60	2 7/8
	Segmented Panel - 42" High	EVPPFA4218	420	448	42	18	2 7/8
		EVPPFA4224	445	479	42	24	2 7/8
		EVPPFA4230	515	556	42	30	2 7/8
		EVPPFA4236	552	599	42	36	2 7/8
		EVPPFA4242	633	686	42	42	2 7/8
		EVPPFA4248	679	740	42	48	2 7/8
		EVPPFA4254	753	820	42	54	2 7/8
		EVPPFA4260	824	897	42	60	2 7/8
	Segmented Panel - 54" High	EVPPFA5418	451	487	54	18	2 7/8
		EVPPFA5424	492	534	54	24	2 7/8
		EVPPFA5430	562	617	54	30	2 7/8
		EVPPFA5436	629	690	54	36	2 7/8
		EVPPFA5442	711	781	54	42	2 7/8
		EVPPFA5448	788	867	54	48	2 7/8
		EVPPFA5454	855	942	54	54	2 7/8
		EVPPFA5460	919	1013	54	60	2 7/8
	Segmented Panel - 66" High	EVPPFA6618	569	613	66	18	2 7/8
		EVPPFA6624	610	667	66	24	2 7/8
		EVPPFA6630	677	741	66	30	2 7/8
		EVPPFA6636	791	870	66	36	2 7/8
		EVPPFA6642	892	979	66	42	2 7/8
		EVPPFA6648	959	1056	66	48	2 7/8
		EVPPFA6654	1039	1148	66	54	2 7/8
		EVPPFA6660	1126	1244	66	60	2 7/8
	Segmented Panel - 66" High	EVPPFA6618S	569	613	66	18	2 7/8
		EVPPFA6624S	610	667	66	24	2 7/8
		EVPPFA6630S	677	741	66	30	2 7/8
		EVPPFA6636S	791	870	66	36	2 7/8
		EVPPFA6642S	892	979	66	42	2 7/8
		EVPPFA6648S	959	1056	66	48	2 7/8
		EVPPFA6654S	1039	1148	66	54	2 7/8
		EVPPFA6660S	1126	1244	66	60	2 7/8

**EVPLFA - SEGMENTED LIGHT PANEL**

- Segmented Light Panel incorporates fabric modules within a solid steel frame.
- There is no base raceway in Light Panels to accommodate electrical.
- Light Panel Connectors must be used in conjunction with Light Panels.
- Fabric covered modules are tackable and acoustical.
- Opposite sides of each panel may have a different fabric within the same grade at no upcharge.
- If different grades of fabric are used on one panel, the entire panel must be priced at highest grade.
- An aluminum low profile top cap is included.
- Stackability: Evolve Light panels can be increased in height in 6”H, 12”H, 18”H or 24”H increments. See Extension Modules for part numbers.

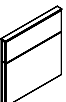
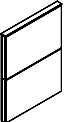
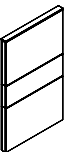
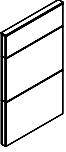
	DESCRIPTION	PRODUCT CODE	LIST PRICE		DIMENSIONS/INCHES		
			Gr1	Gr2	H	W	D
	Segmented Light Panel - 30" High	EVPLFA3018	361	381	30	18	2 7/8
		EVPLFA3024	377	398	30	24	2 7/8
		EVPLFA3030	419	447	30	30	2 7/8
		EVPLFA3036	451	480	30	36	2 7/8
		EVPLFA3042	483	519	30	42	2 7/8
		EVPLFA3048	534	575	30	48	2 7/8
		EVPLFA3054	575	617	30	54	2 7/8
	Segmented Light Panel - 42" High	EVPLFA4218	397	423	42	18	2 7/8
		EVPLFA4224	422	455	42	24	2 7/8
		EVPLFA4230	489	528	42	30	2 7/8
		EVPLFA4236	528	572	42	36	2 7/8
		EVPLFA4242	600	650	42	42	2 7/8
		EVPLFA4248	645	704	42	48	2 7/8
		EVPLFA4254	714	777	42	54	2 7/8
	Segmented Light Panel - 54" High	EVPLFA5418	428	462	54	18	2 7/8
		EVPLFA5424	470	511	54	24	2 7/8
		EVPLFA5430	537	587	54	30	2 7/8
		EVPLFA5436	596	654	54	36	2 7/8
		EVPLFA5442	674	741	54	42	2 7/8
		EVPLFA5448	752	826	54	48	2 7/8
		EVPLFA5454	815	896	54	54	2 7/8
	Segmented Light Panel - 66" High	EVPLFA6618	540	579	66	18	2 7/8
		EVPLFA6624	577	634	66	24	2 7/8
		EVPLFA6630	642	705	66	30	2 7/8
		EVPLFA6636	754	827	66	36	2 7/8
		EVPLFA6642	850	931	66	42	2 7/8
		EVPLFA6648	909	1003	66	48	2 7/8
		EVPLFA6654	987	1089	66	54	2 7/8
	Segmented Light Panel - 66" High	EVPLFA6618S	540	579	66	18	2 7/8
		EVPLFA6624S	577	634	66	24	2 7/8
		EVPLFA6630S	642	705	66	30	2 7/8
		EVPLFA6636S	754	827	66	36	2 7/8
		EVPLFA6642S	850	931	66	42	2 7/8
		EVPLFA6648S	909	1003	66	48	2 7/8
		EVPLFA6654S	987	1089	66	54	2 7/8
EVPLFA6660S	1070	1183	66	60	2 7/8		

**EVFPF - SEGMENTED PREMIUM PANEL**

- Segmented Premium Panel incorporates fabric modules within a solid steel frame.
- Segmented Premium panels incorporate 12" H acoustic modules above 24" base module , plus 6" H base raceway.
- Fabric covered modules are tackable and acoustical.
- Opposite sides of each panel may have a different fabric within the same grade at no upcharge.
- If different grades of fabric are used on one panel, the entire panel must be priced at highest grade.
- An aluminum low profile top cap is included.
- Stackability: Evolve panels can be increased in height in 6"H, 12"H, 18"H or 24"H increments. See Extension Modules for part numbers.

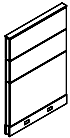
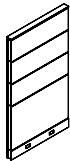
	DESCRIPTION	PRODUCT CODE	LIST PRICE		DIMENSIONS/INCHES		
			Gr1	Gr2	H	W	D
	Segmented Premium Panel - 54" High	EVFPF5418	529	565	54	18	2 7/8
		EVFPF5424	561	605	54	24	2 7/8
		EVFPF5430	618	670	54	30	2 7/8
		EVFPF5436	727	788	54	36	2 7/8
		EVFPF5442	822	892	54	42	2 7/8
		EVFPF5448	879	958	54	48	2 7/8
		EVFPF5454	932	1022	54	54	2 7/8
	Segmented Premium Panel - 66" High	EVFPF6618	665	707	66	18	2 7/8
		EVFPF6624	692	747	66	24	2 7/8
		EVFPF6630	753	820	66	30	2 7/8
		EVFPF6636	797	876	66	36	2 7/8
		EVFPF6642	949	1037	66	42	2 7/8
		EVFPF6648	1038	1136	66	48	2 7/8
		EVFPF6654	1106	1207	66	54	2 7/8
EVFPF6660	1175	1295	66	60	2 7/8		

**EVPLFP - SEGMENTED LIGHT PANEL - PREMIUM**

- Segmented Premium Light Panel incorporates fabric modules within a solid steel frame.
- Segmented Premium panels incorporate 12" H acoustic modules above 24" base module , plus 6" H open base.
- There is no base raceway in Light Panels to accommodate electrical.
- Light Panel Connectors must be used in conjunction with Light Panels.
- Fabric covered modules are tackable and acoustical.
- Opposite sides of each panel may have a different fabric within the same grade at no upcharge.
- If different grades of fabric are used on one panel, the entire panel must be priced at highest grade.
- An aluminum low profile top cap is included.
- Stackability: Evolve Light panels can be increased in height in 6"H, 12"H, 18"H or 24"H increments. See Extension Modules for part numbers.

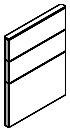
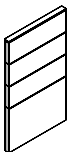
	DESCRIPTION	PRODUCT CODE	LIST PRICE		DIMENSIONS/INCHES		
			Gr1	Gr2	H	W	D
	Segmented Premium Light Panel - Premium - 54" High	EVPLFP5418	503	536	54	18	2 7/8
		EVPLFP5424	534	578	54	24	2 7/8
		EVPLFP5430	587	637	54	30	2 7/8
		EVPLFP5436	693	751	54	36	2 7/8
		EVPLFP5442	782	849	54	42	2 7/8
		EVPLFP5448	834	907	54	48	2 7/8
		EVPLFP5454	888	969	54	54	2 7/8
	Segmented Premium Light Panel - Premium - 66" High	EVPLFP6618	633	674	66	18	2 7/8
		EVPLFP6624	656	708	66	24	2 7/8
		EVPLFP6630	714	777	66	30	2 7/8
		EVPLFP6636	757	831	66	36	2 7/8
		EVPLFP6642	899	986	66	42	2 7/8
		EVPLFP6648	986	1079	66	48	2 7/8
		EVPLFP6654	1051	1150	66	54	2 7/8
EVPLFP6660	1115	1231	66	60	2 1/4		

**EVPBFA - SEGMENTED BELTLINE POWERED PANEL**

- Segmented Beltline Powered Panel incorporates fabric modules with a power beltline raceway, within a solid steel frame.
- A Chimney Panel is required to run electric and data from the base to belt.
- 6”H power beltline raceway, to accommodate electrical, is metal with knockouts on both sides.
- Beltline connectors must be used in conjunction with beltline panels.
- Fabric covered modules are tackable and acoustical.
- Opposite sides of each panel may have a different fabric within the same grade at no upcharge.
- If different grades of fabric are used on one panel, the entire panel must be priced at highest grade.
- An aluminum low profile top cap is included.
- Stackability: Evolve panels can be increased in height in 6”H, 12”H, 18”H or 24”H increments. See Extension Modules for part numbers.

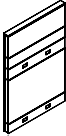
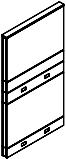
	DESCRIPTION	PRODUCT CODE	LIST PRICE		DIMENSIONS/INCHES		
			Gr1	Gr2	H	W	D
	Segmented Beltline Powered Panel - 54” High 24” Fabric /6” Power /6” Fabric /12” Fabric	EVPBFA5424	616	655	54	24	2 7/8
		EVPBFA5430	722	769	54	30	2 7/8
		EVPBFA5436	830	887	54	36	2 7/8
		EVPBFA5442	930	993	54	42	2 7/8
		EVPBFA5448	1018	1088	54	48	2 7/8
		EVPBFA5454	1115	1194	54	54	2 7/8
		EVPBFA5460	1216	1303	54	60	2 7/8
	Segmented Beltline Powered Panel - 66” High 24” Fabric /6” Power /6” Fabric /24” Fabric	EVPBFA6624	736	788	66	24	2 7/8
		EVPBFA6630	863	922	66	30	2 7/8
		EVPBFA6636	976	1046	66	36	2 7/8
		EVPBFA6642	1099	1178	66	42	2 7/8
		EVPBFA6648	1215	1305	66	48	2 7/8
		EVPBFA6654	1334	1432	66	54	2 7/8
		EVPBFA6660	1450	1559	66	60	2 7/8

**EVPBLFA - SEGMENTED BELTLINE POWERED LIGHT PANEL**

- Segmented Beltline Powered Light Panel incorporates fabric modules with a power beltline raceway, within a solid steel frame.
- There is no base raceway in Light Panels to accommodate electrical.
- 6”H power beltline raceway, to accommodate electrical, is metal with knockouts on both sides.
- Beltline Light Panel Connectors must be used in conjunction with Beltline Light Panels.
- Fabric covered modules are tackable and acoustical.
- Opposite sides of each panel may have a different fabric within the same grade at no upcharge.
- If different grades of fabric are used on one panel, the entire panel must be priced at highest grade.
- An aluminum low profile top cap is included.
- Stackability: Evolve Light panels can be increased in height in 6”H, 12”H, 18”H or 24”H increments. See Extension Modules for part numbers.

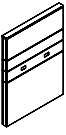
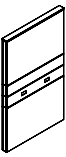
	DESCRIPTION	PRODUCT CODE	LIST PRICE		DIMENSIONS/INCHES		
			Gr1	Gr2	H	W	D
	Segmented Beltline Powered Light Panel - 54” High 24” Fabric /6” Power /6” Fabric /12” Fabric	EVPBLFA5424	565	604	54	24	2 7/8
		EVPBLFA5430	662	709	54	30	2 7/8
		EVPBLFA5436	764	821	54	36	2 7/8
		EVPBLFA5442	858	921	54	42	2 7/8
		EVPBLFA5448	936	1006	54	48	2 7/8
		EVPBLFA5454	1028	1103	54	54	2 7/8
		EVPBLFA5460	1122	1204	54	60	2 7/8
	Segmented Beltline Powered Light Panel - 66” High 24” Fabric /6” Power /6” Fabric /24 Fabric	EVPBLFA6624	679	729	66	24	2 7/8
		EVPBLFA6630	791	850	66	30	2 7/8
		EVPBLFA6636	899	969	66	36	2 7/8
		EVPBLFA6642	1013	1093	66	42	2 7/8
		EVPBLFA6648	1115	1205	66	48	2 7/8
		EVPBLFA6654	1227	1324	66	54	2 7/8
		EVPBLFA6660	1335	1444	66	60	2 7/8

**EVPBCFA - SEGMENTED BELTLINE POWERED CHIMNEY PANEL**

- Segmented Chimney Beltline Powered Panel incorporates fabric modules with a power beltline raceway, within a solid steel frame.
- A Chimney Panel is required to run electric and data from the base to belt.
- Separate electric harness required to go from base to belt (see EVE8CPCP).
- 6”H power beltline raceway, to accommodate electrical, is metal with knockouts on both sides.
- Beltline Connectors must be used in conjunction with beltline panels.
- Fabric covered modules are tackable and acoustical.
- Opposite sides of each panel may have a different fabric within the same grade at no upcharge.
- If different grades of fabric are used on one panel, the entire panel must be priced at highest grade.
- An aluminum low profile top cap is included.
- Stackability: Evolve panels can be increased in height in 6”H, 12”H, 18”H or 24”H increments. See Extension Modules for part numbers.

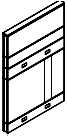
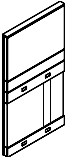
	DESCRIPTION	PRODUCT CODE	LIST PRICE		DIMENSIONS/INCHES		
			Gr1	Gr2	H	W	D
	Segmented Beltline Powered Chimney Panel - 54” High 24” Fabric Chimney /6” Power / 6” Fabric /12” Fabric	EVPBCFA5436	917	972	54	36	2 7/8
		EVPBCFA5442	1018	1079	54	42	2 7/8
	Segmented Beltline Powered Chimney Panel - 66” High 24” Fabric Chimney /6” Power / 6” Fabric /24” Fabric	EVPBCFA6636	1062	1132	66	36	2 7/8
		EVPBCFA6642	1185	1265	66	42	2 7/8

**EVE8CPCP - CHIMNEY PANEL JUMPER CABLE KIT**

- Contains two (2) 17” flexible harnesses and one (1) “I” connector.
- Used to connect electric from the base to the beltline raceway in Beltline Powered Chimney panel.
- Must use in conjunction with base power distribution harness and beltline power distribution harness (sold separately)

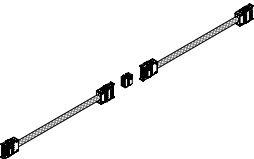
	DESCRIPTION	PRODUCT CODE	LIST PRICE	DIMENSIONS/INCHES		
				H	W	D
	Chimney Panel Jumper Cable Kit	EVE8CPCP	365			

**EVPBFFA - SEGMENTED BELTLINE NON-POWERED PANEL**

- Double Beltline Non-Powered Panel incorporates all fabric modules within a solid steel frame.
- Electrical cannot pass through panel at the beltline level.
- Fabric covered modules are tackable and acoustical.
- Opposite sides of each panel may have a different fabric within the same grade at no upcharge.
- If different grades of fabric are used on one panel, the entire panel must be priced at highest grade.
- An aluminum low profile top cap is included.
- Stackability: Evolve panels can be increased in height in 6”H, 12”H, 18”H or 24”H increments. See Extension Modules for part numbers.

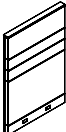
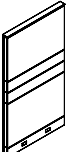
	DESCRIPTION	PRODUCT CODE	LIST PRICE		DIMENSIONS/INCHES		
			Gr1	Gr2	H	W	D
	Segmented Beltline Non-Powered Panel - 54” High	EVPBFFA5424	594	632	54	24	2 7/8
		EVPBFFA5430	650	703	54	30	2 7/8
	24” Fabric /6” Fabric /6” Fabric /12” Fabric	EVPBFFA5436	764	827	54	36	2 7/8
		EVPBFFA5442	863	933	54	42	2 7/8
		EVPBFFA5448	925	1004	54	48	2 7/8
		EVPBFFA5454	975	1065	54	54	2 7/8
		EVPBFFA5460	1023	1118	54	60	2 7/8
	Segmented Beltline Non-Powered Panel - 66” High	EVPBFFA6624	644	699	66	24	2 7/8
		EVPBFFA6630	756	822	66	30	2 7/8
	24” Fabric /6” Fabric /6” Fabric /24” Fabric	EVPBFFA6636	871	945	66	36	2 7/8
		EVPBFFA6642	981	1071	66	42	2 7/8
		EVPBFFA6648	1072	1170	66	48	2 7/8
		EVPBFFA6654	1177	1286	66	54	2 7/8
		EVPBFFA6660	1280	1400	66	60	2 7/8

**EVPBLFFA - SEGMENTED BELTLINE NON-POWERED LIGHT PANEL**

- Double Beltline Non-Powered Panel incorporates all fabric modules within a solid steel frame.
- Electrical cannot pass through panel at the beltline level.
- There is no base raceway in Light Panels to accommodate electrical
- Fabric covered modules are tackable and acoustical.
- Opposite sides of each panel may have a different fabric within the same grade at no upcharge.
- If different grades of fabric are used on one panel, the entire panel must be priced at highest grade.
- An aluminum low profile top cap is included.
- Stackability: Evolve panels can be increased in height in 6”H, 12”H, 18”H or 24”H increments.
- See Extension Modules for part numbers.

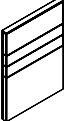
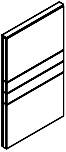
	DESCRIPTION	PRODUCT CODE	LIST PRICE		DIMENSIONS/INCHES		
			Gr1	Gr2	H	W	D
	Segmented Beltline Non-Powered Light Panel - 54” High	EVPBLFFA5424	489	533	54	24	2 7/8
		EVPBLFFA5430	577	630	54	30	2 7/8
	24” Fabric /6” Fabric /6” Fabric /12” Fabric	EVPBLFFA5436	655	718	54	36	2 7/8
		EVPBLFFA5442	733	803	54	42	2 7/8
		EVPBLFFA5448	815	894	54	48	2 7/8
		EVPBLFFA5454	927	1015	54	54	2 7/8
		EVPBLFFA5460	972	1069	54	60	2 7/8
	Segmented Beltline Non-Powered Light Panel - 66” High	EVPBLFFA6624	610	665	66	24	2 7/8
		EVPBLFFA6630	677	741	66	30	2 7/8
	24” Fabric /6” Fabric /6” Fabric /24” Fabric	EVPBLFFA6636	791	865	66	36	2 7/8
		EVPBLFFA6642	892	980	66	42	2 7/8
		EVPBLFFA6648	959	1057	66	48	2 7/8
		EVPBLFFA6654	1039	1148	66	54	2 7/8
		EVPBLFFA6660	1126	1244	66	60	2 7/8

**EVPMGU - MONOLITHIC 12”H GLAZED PANEL - TEMPERED GLASS**

- Monolithic 12”H Glazed Panel incorporates a lower fabric module with a 12”H top position glazed module, into a solid steel frame.
- Fabric covered modules are tackable and acoustical.
- Opposite sides of each panel may have a different fabric within the same grade at no upcharge.
- If different grades of fabric are used on one panel, the entire panel must be priced at highest grade.
- An aluminum low profile top cap is included.
- Stackability: Evolve panels can be increased in height in 6”H, 12”H, 18”H or 24”H increments. See Extension Modules for part numbers.
- Standard in clear (CLR) glass.
- Frosted glass (FRST) 20% upcharge.

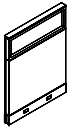
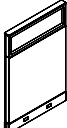
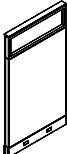
	DESCRIPTION	PRODUCT CODE	LIST PRICE		DIMENSIONS/INCHES		
			Gr1	Gr2	H	W	D
	Monolithic 12”H Glazed Panel - Tempered Glass - 48” High	EVPMGU4818	577	611	48	18	2 7/8
		EVPMGU4824	676	723	48	24	2 7/8
		EVPMGU4830	784	841	48	30	2 7/8
		EVPMGU4836	894	960	48	36	2 7/8
		EVPMGU4842	992	1063	48	42	2 7/8
		EVPMGU4848	1079	1166	48	48	2 7/8
		EVPMGU4854	1198	1285	48	54	2 7/8
		EVPMGU4860	1313	1414	48	60	2 7/8
	Monolithic 12”H Glazed Panel - Tempered Glass - 54” High	EVPMGU5418	595	634	54	18	2 7/8
		EVPMGU5424	692	739	54	24	2 7/8
		EVPMGU5430	788	847	54	30	2 7/8
		EVPMGU5436	879	940	54	36	2 7/8
		EVPMGU5442	975	1048	54	42	2 7/8
		EVPMGU5448	1079	1166	54	48	2 7/8
		EVPMGU5454	1181	1274	54	54	2 7/8
		EVPMGU5460	1279	1380	54	60	2 7/8
	Monolithic 12”H Glazed Panel - Tempered Glass - 66” High	EVPMGU6618	635	673	66	18	2 7/8
		EVPMGU6624	760	810	66	24	2 7/8
		EVPMGU6630	866	925	66	30	2 7/8
		EVPMGU6636	970	1036	66	36	2 7/8
		EVPMGU6642	1078	1151	66	42	2 7/8
		EVPMGU6648	1189	1271	66	48	2 7/8
		EVPMGU6654	1301	1392	66	54	2 7/8
		EVPMGU6660	1417	1515	66	60	2 7/8

**EVPLMGU - MONOLITHIC 12”H GLAZED LIGHT PANEL - TEMPERED GLASS**

- Monolithic 12”H Glazed Light Panel incorporates a lower fabric module with a 12”H top position glazed module, into a solid steel frame.
- There is no base raceway in Light Panels to accommodate electrical.
- Light Panel Connectors must be used in conjunction with Light Panels.
- Fabric covered modules are tackable and acoustical.
- Opposite sides of each panel may have a different fabric within the same grade at no upcharge.
- If different grades of fabric are used on one panel, the entire panel must be priced at highest grade.
- An aluminum low profile top cap is included.
- Stackability: Evolve panels can be increased in height in 6”H, 12”H, 18”H or 24”H increments. See Extension Modules for part numbers.
- Standard in clear (CLR) glass.
- Frosted glass (FRST) 20% upcharge.

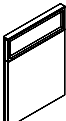
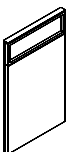
	DESCRIPTION	PRODUCT CODE	LIST PRICE		DIMENSIONS/INCHES		
			Gr1	Gr2	H	W	D
	Monolithic 12”H Glazed Light Panel - Tempered Glass - 48” High	EVPLMGU4818	564	600	48	18	2 7/8
		EVPLMGU4824	660	707	48	24	2 7/8
		EVPLMGU4830	766	823	48	30	2 7/8
		EVPLMGU4836	879	942	48	36	2 7/8
		EVPLMGU4842	973	1044	48	42	2 7/8
		EVPLMGU4848	1056	1138	48	48	2 7/8
		EVPLMGU4854	1172	1254	48	54	2 7/8
		EVPLMGU4860	1289	1388	48	60	2 7/8
	Monolithic 12”H Glazed Light Panel - Tempered Glass - 54” High	EVPLMGU5418	583	622	54	18	2 7/8
		EVPLMGU5424	678	722	54	24	2 7/8
		EVPLMGU5430	772	830	54	30	2 7/8
		EVPLMGU5436	863	924	54	36	2 7/8
		EVPLMGU5442	959	1030	54	42	2 7/8
		EVPLMGU5448	1056	1138	54	48	2 7/8
		EVPLMGU5454	1156	1246	54	54	2 7/8
		EVPLMGU5460	1257	1355	54	60	2 7/8
	Monolithic 12”H Glazed Light Panel - Tempered Glass - 66” High	EVPLMGU6618	622	658	66	18	2 7/8
		EVPLMGU6624	745	795	66	24	2 7/8
		EVPLMGU6630	851	908	66	30	2 7/8
		EVPLMGU6636	950	1013	66	36	2 7/8
		EVPLMGU6642	1053	1126	66	42	2 7/8
		EVPLMGU6648	1165	1246	66	48	2 7/8
		EVPLMGU6654	1275	1368	66	54	2 7/8
		EVPLMGU6660	1386	1481	66	60	2 7/8

**EVPFGTU - FABRIC 12”H GLAZED PANEL - TEMPERED GLASS**

- Segmented 12”H Glazed Panel incorporates a lower fabric module with a 12”H top position glazed module, into a solid steel frame.
- Panels incorporate 12”H acoustic modules above 30”H base section with a 12”H glazed module at the top.
- Fabric covered modules are tackable and acoustical.
- Opposite sides of each panel may have a different fabric within the same grade at no upcharge.
- If different grades of fabric are used on one panel, the entire panel must be priced at highest grade.
- An aluminum low profile top cap is included.
- Stackability: Evolve panels can be increased in height in 6”H, 12”H, 18”H or 24”H increments. See Extension Modules for part numbers.
- Standard in clear (CLR) glass.
- Frosted glass (FRST) 20% upcharge.

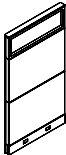
	DESCRIPTION	PRODUCT CODE	LIST PRICE		DIMENSIONS/INCHES		
			Gr1	Gr2	H	W	D
	Fabric 12” Glazed Panel - Tempered Glass 66” High	EVPFGTU6618	712	748	66	18	2 7/8
		EVPFGTU6624	830	877	66	24	2 7/8
		EVPFGTU6630	947	1000	66	30	2 7/8
		EVPFGTU6636	1059	1122	66	36	2 7/8
		EVPFGTU6642	1197	1266	66	42	2 7/8
		EVPFGTU6648	1298	1377	66	48	2 7/8
		EVPFGTU6654	1450	1538	66	54	2 7/8
		EVPFGTU6660	1598	1692	66	60	2 7/8

**EVPLFGTU - FABRIC 12”H GLAZED LIGHT PANEL**

- Segmented 12”H Glazed Light Panel incorporates a lower fabric module with a 12”H top position glazed module, into a solid steel frame.
- Panels incorporate 12”H acoustic modules above 30”H base section with a 12”H glazed module at the top.
- There is no base raceway in Light Panels to accommodate electrical.
- Light Panel Connectors must be used in conjunction with Light Panels.
- Opposite sides of each panel may have a different fabric within the same grade at no upcharge.
- If different grades of fabric are used on one panel, the entire panel must be priced at highest grade.
- An aluminum low profile top cap is included.
- Stackability: Evolve panels can be increased in height in 6”H, 12”H, 18”H or 24”H increments.
- See Extension Modules for part numbers.
- Standard in clear (CLR) glass.
- Frosted glass (FRST) 20% upcharge.

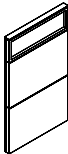
	DESCRIPTION	PRODUCT CODE	LIST PRICE		DIMENSIONS/INCHES		
			Gr1	Gr2	H	W	D
	Fabric 12”H Glazed Light Panel - 66” High	EVPLFGTU6618	695	729	66	18	2 7/8
		EVPLFGTU6624	817	864	66	24	2 7/8
		EVPLFGTU6630	928	980	66	30	2 7/8
		EVPLFGTU6636	1041	1102	66	36	2 7/8
		EVPLFGTU6642	1171	1238	66	42	2 7/8
		EVPLFGTU6648	1271	1346	66	48	2 7/8
		EVPLFGTU6654	1420	1507	66	54	2 7/8
		EVPLFGTU6660	1568	1661	66	60	2 7/8

**EVFPFGTU - SEGMENTED 12”H GLAZED PANEL - PREMIUM - TEMPERED GLASS**

- Segmented 12”H Glazed Premium Panel incorporates a lower fabric module with a 12”H top position glazed module, into a solid steel frame.
- Premium panels incorporate a 6”H base raceway, 24”H base module, 12”H acoustic module and a 12”H glazed module at the top.
- Fabric covered modules are tackable and acoustical.
- Opposite sides of each panel may have a different fabric within the same grade at no upcharge.
- If different grades of fabric are used on one panel, the entire panel must be priced at highest grade.
- An aluminum low profile top cap is included.
- Stackability: Evolve panels can be increased in height in 6”H, 12”H, 18”H or 24”H increments. See Extension Modules for part numbers.
- Standard in clear (CLR) glass.
- Frosted glass (FRST) 20% upcharge.

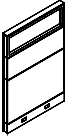
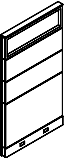
	DESCRIPTION	PRODUCT CODE	LIST PRICE		DIMENSIONS/INCHES		
			Gr1	Gr2	H	W	D
	Segmented 12”H Glazed Premium Panel - Tempered Glass - 54” High	EVFPFGTU5418	655	682	54	18	2 7/8
		EVFPFGTU5424	768	802	54	24	2 7/8
		EVFPFGTU5430	867	909	54	30	2 7/8
		EVFPFGTU5436	975	1025	54	36	2 7/8
		EVFPFGTU5442	1094	1149	54	42	2 7/8
		EVFPFGTU5448	1189	1248	54	48	2 7/8
		EVFPFGTU5454	1334	1400	54	54	2 7/8
	Segmented 12”H Glazed Premium Panel - Tempered Glass - 66” High	EVFPFGTU6618	801	834	66	18	2 7/8
		EVFPFGTU6624	940	988	66	24	2 7/8
		EVFPFGTU6630	1070	1122	66	30	2 7/8
		EVFPFGTU6636	1201	1264	66	36	2 7/8
		EVFPFGTU6642	1356	1426	66	42	2 7/8
		EVFPFGTU6648	1467	1546	66	48	2 7/8
		EVFPFGTU6654	1641	1729	66	54	2 7/8
EVFPFGTU6660	1822	1919	66	60	2 7/8		

**EVPLFPGTU - SEGMENTED 12”H GLAZED PREMIUM LIGHT PANEL – TEMPERED GLASS**

- Segmented 12”H Glazed Premium Light Panel incorporates a lower fabric module with a 12”H top position glazed module, into a solid steel frame.
- Premium panels incorporate a 30”H base section, 12”H acoustic module and a 12”H glazed module at the top.
- There is no base raceway in Light Panels to accommodate electrical.
- Light Panel Connectors must be used in conjunction with Light Panels.
- Opposite sides of each panel may have a different fabric within the same grade at no upcharge.
- If different grades of fabric are used on one panel, the entire panel must be priced at highest grade.
- An aluminum low profile top cap is included.
- Stackability: Evolve panels can be increased in height in 6”H, 12”H, 18”H or 24”H increments.
- See Extension Modules for part numbers.
- Standard in clear (CLR) glass.
- Frosted glass (FRST) 20% upcharge.

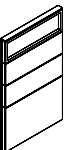
	DESCRIPTION	PRODUCT CODE	LIST PRICE		DIMENSIONS/INCHES		
			Gr1	Gr2	H	W	D
	Segmented 12”H Glazed Premium Panel - Premium - Tempered Glass - 54” High	EVPLFPGTU5418	642	668	54	18	2 7/8
		EVPLFPGTU5424	754	788	54	24	2 7/8
		EVPLFPGTU5430	852	893	54	30	2 7/8
		EVPLFPGTU5436	959	1006	54	36	2 7/8
		EVPLFPGTU5442	1075	1132	54	42	2 7/8
		EVPLFPGTU5448	1165	1226	54	48	2 7/8
		EVPLFPGTU5454	1306	1370	54	54	2 7/8
	Segmented 12”H Glazed Premium Panel - Premium - Tempered Glass - 66” High	EVPLFPGTU6618	787	819	66	18	2 7/8
		EVPLFPGTU6624	923	970	66	24	2 7/8
		EVPLFPGTU6630	1047	1099	66	30	2 7/8
		EVPLFPGTU6636	1180	1241	66	36	2 7/8
		EVPLFPGTU6642	1329	1398	66	42	2 7/8
		EVPLFPGTU6648	1439	1514	66	48	2 7/8
		EVPLFPGTU6654	1607	1694	66	54	2 7/8
EVPLFPGTU6660	1786	1881	66	60	2 7/8		

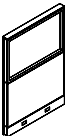
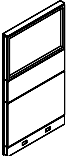

**EVPPFGT - PARTLY GLAZED PANEL - TEMPERED GLASS**

- Partly Glazed Panel incorporates a lower fabric module with a 12”H or 24”H top position glazed module, into a solid steel frame.
- Opposite sides of each panel may have a different fabric within the same grade at no upcharge.
- If different grades of fabric are used on one panel, the entire panel must be priced at highest grade.
- An aluminum low profile top cap is included.
- Stackability: Evolve panels can be increased in height in 6”H, 12”H, 18”H or 24”H increments. See Extension Modules for part numbers.
- Standard in clear (CLR) glass.
- Frosted glass (FRST) 20% upcharge.

	DESCRIPTION	PRODUCT CODE	LIST PRICE		DIMENSIONS/INCHES		
			Gr1	Gr2	H	W	D
	Partly Glazed Panel - Tempered Glass - 42" High	EVPPFGT4218	504	524	42	18	2 7/8
		EVPPFGT4224	595	621	42	24	2 7/8
		EVPPFGT4230	674	702	42	30	2 7/8
		EVPPFGT4236	752	786	42	36	2 7/8
		EVPPFGT4242	835	873	42	42	2 7/8
		EVPPFGT4248	914	955	42	48	2 7/8
		EVPPFGT4254	1021	1065	42	54	2 7/8
		EVPPFGT4260	1127	1177	42	60	2 7/8
	Partly Glazed Panel - Tempered Glass - 54" High	EVPPFGT5418	557	578	54	18	2 7/8
		EVPPFGT5424	647	673	54	24	2 7/8
		EVPPFGT5430	752	781	54	30	2 7/8
		EVPPFGT5436	852	886	54	36	2 7/8
		EVPPFGT5442	952	988	54	42	2 7/8
		EVPPFGT5448	1038	1079	54	48	2 7/8
		EVPPFGT5454	1203	1247	54	54	2 7/8
		EVPPFGT5460	1366	1419	54	60	2 7/8
	Partly Glazed Panel - Tempered Glass - 66" High	EVPPFGT6618	706	734	66	18	2 7/8
		EVPPFGT6624	821	857	66	24	2 7/8
		EVPPFGT6630	947	988	66	30	2 7/8
		EVPPFGT6636	1078	1126	66	36	2 7/8
		EVPPFGT6642	1211	1268	66	42	2 7/8
		EVPPFGT6648	1316	1377	66	48	2 7/8
		EVPPFGT6654	1513	1580	66	54	2 7/8
		EVPPFGT6660	1712	1783	66	60	2 7/8

**EVPLFGT - PARTLY GLAZED LIGHT PANEL - TEMPERED GLASS**

- Partly Glazed Light Panel incorporates a lower fabric module with a 12”H or 24”H top position glazed module, into a solid steel frame.
- There is no base raceway in Light Panels to accommodate electrical.
- Light Panel Connectors must be used in conjunction with Light Panels.
- Opposite sides of each panel may have a different fabric within the same grade at no upcharge.
- If different grades of fabric are used on one panel, the entire panel must be priced at highest grade.
- An aluminum low profile top cap is included.
- Stackability: Evolve panels can be increased in height in 6”H, 12”H, 18”H or 24”H increments. See Extension Modules for part numbers.
- Standard in clear (CLR) glass.
- Frosted glass (FRST) 20% upcharge.

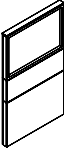
	DESCRIPTION	PRODUCT CODE	LIST PRICE		DIMENSIONS/INCHES		
			Gr1	Gr2	H	W	D
	Partly Glazed Light Panel - Tempered Glass - 42” High	EVPLFGT4218	493	514	42	18	2 7/8
		EVPLFGT4224	583	609	42	24	2 7/8
		EVPLFGT4230	659	688	42	30	2 7/8
		EVPLFGT4236	733	767	42	36	2 7/8
		EVPLFGT4242	821	859	42	42	2 7/8
		EVPLFGT4248	893	934	42	48	2 7/8
		EVPLFGT4254	998	1042	42	54	2 7/8
		EVPLFGT4260	1105	1153	42	60	2 7/8
	Partly Glazed Light Panel - Tempered Glass - 54” High	EVPLFGT5418	547	565	54	18	2 7/8
		EVPLFGT5424	635	661	54	24	2 7/8
		EVPLFGT5430	733	762	54	30	2 7/8
		EVPLFGT5436	832	866	54	36	2 7/8
		EVPLFGT5442	934	970	54	42	2 7/8
		EVPLFGT5448	1018	1059	54	48	2 7/8
		EVPLFGT5454	1181	1228	54	54	2 7/8
		EVPLFGT5460	1339	1392	54	60	2 7/8
	Partly Glazed Light Panel - Tempered Glass - 66” High	EVPLFGT6618	693	722	66	18	2 7/8
		EVPLFGT6624	801	837	66	24	2 7/8
		EVPLFGT6630	928	969	66	30	2 7/8
		EVPLFGT6636	1053	1100	66	36	2 7/8
		EVPLFGT6642	1189	1242	66	42	2 7/8
		EVPLFGT6648	1292	1350	66	48	2 7/8
		EVPLFGT6654	1482	1549	66	54	2 7/8
		EVPLFGT6660	1679	1749	66	60	2 7/8

**EVPPFGTX - PARTLY GLAZED PANEL - 36”H TEMPERED GLASS**

- Partly Glazed Panel incorporates a lower fabric module with 36”H top position glazed module, into a solid steel frame.
- Opposite sides of each panel may have a different fabric within the same grade at no upcharge.
- If different grades of fabric are used on one panel, the entire panel must be priced at highest grade.
- An aluminum low profile top cap is included.
- Stackability: Evolve panels can be increased in height in 6”H, 12”H, 18”H or 24”H increments. See Extension Modules for part numbers.
- Standard in clear (CLR) glass.
- Frosted glass (FRST) 40% upcharge.

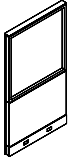
	DESCRIPTION	PRODUCT CODE	LIST PRICE		DIMENSIONS/INCHES		
			Gr1	Gr2	H	W	D
	Fabric 36” Glazed Panel -	EVPPFGTX6618	818	836	66	18	2 7/8
	Tempered Glass - 66” High	EVPPFGTX6624	901	928	66	24	2 7/8
		EVPPFGTX6630	1045	1074	66	30	2 7/8
		EVPPFGTX6636	1188	1221	66	36	2 7/8
		EVPPFGTX6642	1328	1366	66	42	2 7/8
		EVPPFGTX6648	1454	1495	66	48	2 7/8
		EVPPFGTX6654	1598	1642	66	54	2 7/8
		EVPPFGTX6660	1742	1794	66	60	2 7/8

**EVPLFGTX - PARTLY GLAZED LIGHT PANEL - 36”H TEMPERED GLASS**

- Partly Glazed Light Panel incorporates a lower fabric module with 36”H top position glazed module, into a solid steel frame.
- There is no base raceway in Light Panels to accommodate electrical.
- Light Panel Connectors must be used in conjunction with Light Panels.
- Opposite sides of each panel may have a different fabric within the same grade at no upcharge.
- If different grades of fabric are used on one panel, the entire panel must be priced at highest grade.
- An aluminum low profile top cap is included.
- Stackability: Evolve panels can be increased in height in 6”H, 12”H, 18”H or 24”H increments. See Extension Modules for part numbers.
- Standard in clear (CLR) glass.
- Frosted glass (FRST) 40% upcharge.

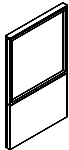
	DESCRIPTION	PRODUCT CODE	LIST PRICE		DIMENSIONS/INCHES		
			Gr1	Gr2	H	W	D
	Partly Glazed Light Panel -	EVPLFGTX6618	789	807	66	18	2 7/8
	36”H Tempered Glass - 66” High	EVPLFGTX6624	874	901	66	24	2 7/8
		EVPLFGTX6630	1015	1043	66	30	2 7/8
		EVPLFGTX6636	1150	1184	66	36	2 7/8
		EVPLFGTX6642	1289	1325	66	42	2 7/8
		EVPLFGTX6648	1410	1449	66	48	2 7/8
		EVPLFGTX6654	1550	1592	66	54	2 7/8
		EVPLFGTX6660	1691	1743	66	60	2 7/8

**EVPBFGT - PARTLY GLAZED BELTLINE POWERED PANEL**

- Partly Glazed Beltline Powered Panel incorporates fabric modules with a power beltline raceway and a 12”H or 24”H glazed module, within a solid steel frame.
- A Chimney Panel is required to run electric and data from the base to belt.
- 6”H power beltline raceway, to accommodate electrical, is metal with knockouts on both sides.
- Beltline Connectors must be used in conjunction with beltline panels.
- Opposite sides of each panel may have a different fabric within the same grade at no upcharge.
- If different grades of fabric are used on one panel, the entire panel must be priced at highest grade.
- An aluminum low profile top cap is included.
- Stackability: Evolve panels can be increased in height in 6”H, 12”H, 18”H or 24”H increments. See Extension Modules for part numbers.
- Standard in clear (CLR) glass.
- Frosted glass (FRST) 20% upcharge.

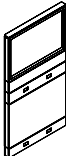
	DESCRIPTION	PRODUCT CODE	LIST PRICE		DIMENSIONS/INCHES		
			Gr1	Gr2	H	W	D
	Partly Glazed Beltline Powered Panel - 54” High	EVPBFGT5424	824	853	54	24	2 7/8
	24” Fabric /6” Power Belt/ 6” Fabric /12” Glass	EVPBFGT5430	966	1000	54	30	2 7/8
		EVPBFGT5436	1098	1139	54	36	2 7/8
		EVPBFGT5442	1236	1283	54	42	2 7/8
		EVPBFGT5448	1370	1422	54	48	2 7/8
		EVPBFGT5454	1503	1560	54	54	2 7/8
		EVPBFGT5460	1639	1700	54	60	2 7/8
	Partly Glazed Beltline Powered Panel - 66” High	EVPBFGT6624	936	965	66	24	2 7/8
	24” Fabric /6” Power Belt/ 6” Fabric /24” Glass	EVPBFGT6630	1091	1125	66	30	2 7/8
		EVPBFGT6636	1241	1282	66	36	2 7/8
		EVPBFGT6642	1394	1441	66	42	2 7/8
		EVPBFGT6648	1537	1589	66	48	2 7/8
		EVPBFGT6654	1691	1730	66	54	2 7/8
		EVPBFGT6660	1841	1902	66	60	2 7/8

**EVPBLFGT - PARTLY GLAZED BELTLINE POWER LIGHT PANEL**

- Partly Glazed Beltline Powered Light Panel incorporates fabric modules with a power beltline raceway and a 12”H or 24”H glazed module, within a solid steel frame.
- 6”H power beltline raceway, to accommodate electrical, is metal with knockouts on both sides.
- There is no base raceway in Light Panels to accommodate electrical.
- Light Beltline Panel Connectors must be used in conjunction with Light Beltline Panels.
- Opposite sides of each panel may have a different fabric within the same grade at no upcharge.
- If different grades of fabric are used on one panel, the entire panel must be priced at highest grade.
- An aluminum low profile top cap is included.
- Stackability: Evolve Light panels can be increased in height in 6”H, 12”H, 18”H or 24”H increments. See Extension Modules for part numbers.
- Standard in clear (CLR) glass.
- Frosted glass (FRST) 20% upcharge.

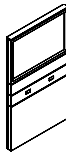
	DESCRIPTION	PRODUCT CODE	LIST PRICE		DIMENSIONS/INCHES		
			Gr1	Gr2	H	W	D
	Partly Glazed Beltline Powered Light Panel - 54” High	EVPBLFGT5424	785	814	54	24	2 7/8
	24” Fabric /6” Power Belt/ 6” Fabric /12” Glass	EVPBLFGT5430	919	953	54	30	2 7/8
		EVPBLFGT5436	1043	1084	54	36	2 7/8
		EVPBLFGT5442	1175	1222	54	42	2 7/8
		EVPBLFGT5448	1301	1353	54	48	2 7/8
		EVPBLFGT5454	1429	1486	54	54	2 7/8
		EVPBLFGT5460	1556	1619	54	60	2 7/8
	Partly Glazed Beltline Powered Light Panel - 66” High	EVPBLFGT6624	889	918	66	24	2 7/8
	24” Fabric /6” Power Belt/ 6” Fabric /24” Glass	EVPBLFGT6630	1036	1070	66	30	2 7/8
		EVPBLFGT6636	1180	1221	66	36	2 7/8
		EVPBLFGT6642	1322	1370	66	42	2 7/8
		EVPBLFGT6648	1464	1516	66	48	2 7/8
		EVPBLFGT6654	1607	1664	66	54	2 7/8
		EVPBLFGT6660	1747	1810	66	60	2 7/8

**EVPBCFGT - PARTLY GLAZED BELTLINE POWERED CHIMNEY PANEL - TEMPERED GLASS**

- Partly Glazed Beltline Powered Chimney Panel incorporates fabric modules with a power beltline raceway and a 12”H or 24”H glazed module, within a solid steel frame.
- A Chimney Panel is required to run electric and data from the base to belt.
- Separate electric harness required to go from base to belt (see EVE8CPCP).
- 6”H power beltline raceway, to accommodate electrical, is metal with knockouts on both sides.
- Beltline Connectors must be used in conjunction with beltline panels.
- Opposite sides of each panel may have a different fabric within the same grade at no upcharge.
- If different grades of fabric are used on one panel, the entire panel must be priced at highest grade.
- An aluminum low profile top cap is included.
- Stackability: Evolve panels can be increased in height in 6”H, 12”H, 18”H or 24”H increments. See Extension Modules for part numbers.
- Standard in clear (CLR) glass.
- Frosted glass (FRST) 20% upcharge.

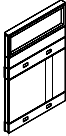
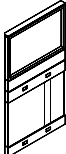
	DESCRIPTION	PRODUCT CODE	LIST PRICE		DIMENSIONS/INCHES		
			Gr1	Gr2	H	W	D
	Partly Glazed Beltline Powered Chimney Panel - Tempered Glass - 54” High	EVPBCFGT5436	1183	1225	54	36	2 7/8
	24” Fabric Chimney /6” Power Belt / 6” Fabric /12” Glass	EVPBCFGT5442	1322	1370	54	42	2 7/8
	Partly Glazed Beltline Powered Chimney Panel - Tempered Glass - 66” High	EVPBCFGT6636	1342	1383	66	36	2 7/8
	24” Fabric Chimney /6” Power Belt / 6” Fabric /24” Glass	EVPBCFGT6642	1480	1527	66	42	2 7/8

**EVE8CPCP - CHIMNEY PANEL JUMPER CABLE KIT**

- Contains two (2) 17” flexible harnesses and one (1) “I” connector.
- Used to connect electric from the base to the beltline raceway in Beltline Powered Chimney panel.
- Must use in conjunction with base power distribution harness and beltline power distribution harness (sold separately)

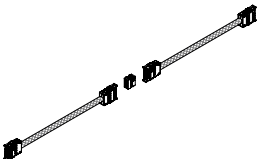
	DESCRIPTION	PRODUCT CODE	LIST PRICE	DIMENSIONS/INCHES		
				H	W	D
	Chimney Panel Jumper Cable Kit	EVE8CPCP	365			

**EVFPFGT - PARTLY GLAZED PREMIUM PANEL - TEMPERED GLASS**

- Partly Glazed Premium Panel incorporates 12”H glazed modules above 30”H fabric base section.
- Opposite sides of each panel may have a different fabric within the same grade at no upcharge.
- If different grades of fabric are used on one panel, the entire panel must be priced at highest grade.
- An aluminum low profile top cap is included.
- Stackability: Evolve panels can be increased in height in 6”H, 12”H, 18”H or 24”H increments. See Extension Modules for part numbers.
- Standard in clear (CLR) glass.
- Frosted glass (FRST) 20% upcharge.

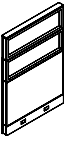
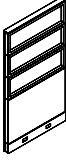
	DESCRIPTION	PRODUCT CODE	LIST PRICE		DIMENSIONS/INCHES		
			Gr1	Gr2	H	W	D
	Partly Glazed Premium Panel - Tempered Glass - 54” High	EVFPFGT5418	674	695	54	18	2 7/8
		EVFPFGT5424	801	824	54	24	2 7/8
		EVFPFGT5430	898	927	54	30	2 7/8
		EVFPFGT5436	998	1032	54	36	2 7/8
		EVFPFGT5442	1113	1151	54	42	2 7/8
		EVFPFGT5448	1225	1266	54	48	2 7/8
		EVFPFGT5454	1370	1418	54	54	2 7/8
		EVFPFGT5460	1511	1564	54	60	2 7/8
	Partly Glazed Premium Panel - Tempered Glass - 66” High	EVFPFGT6618	839	859	66	18	2 7/8
		EVFPFGT6624	1008	1036	66	24	2 7/8
		EVFPFGT6630	1133	1162	66	30	2 7/8
		EVFPFGT6636	1245	1279	66	36	2 7/8
		EVFPFGT6642	1388	1426	66	42	2 7/8
		EVFPFGT6648	1534	1576	66	48	2 7/8
		EVFPFGT6654	1734	1784	66	54	2 7/8
		EVFPFGT6660	1930	1983	66	60	2 7/8

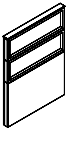
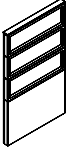

**EVPLFPGT - PARTLY GLAZED PREMIUM LIGHT PANEL – TEMPERED GLASS**

- Partly Glazed Premium Panel incorporates 12”H glazed modules above 30”H fabric base section.
- There is no base raceway in Light Panels to accommodate electrical.
- Light Panel Connectors must be used in conjunction with Light Panels.
- Opposite sides of each panel may have a different fabric within the same grade at no upcharge.
- If different grades of fabric are used on one panel, the entire panel must be priced at highest grade.
- An aluminum low profile top cap is included.
- Stackability: Evolve panels can be increased in height in 6”H, 12”H, 18”H or 24”H increments.
- See Extension Modules for part numbers.
- Standard in clear (CLR) glass.
- Frosted glass (FRST) 20% upcharge.

	DESCRIPTION	PRODUCT CODE	LIST PRICE		DIMENSIONS/INCHES		
			Gr1	Gr2	H	W	D
	Partly Glazed Premium Light Panel - Tempered Glass - 54” High	EVPLFPGT5418	651	672	54	18	2 7/8
		EVPLFPGT5424	779	800	54	24	2 7/8
		EVPLFPGT5430	870	899	54	30	2 7/8
		EVPLFPGT5436	972	1005	54	36	2 7/8
		EVPLFPGT5442	1080	1116	54	42	2 7/8
		EVPLFPGT5448	1189	1228	54	48	2 7/8
		EVPLFPGT5454	1328	1375	54	54	2 7/8
		EVPLFPGT5460	1465	1517	54	60	2 7/8
	Partly Glazed Premium Light Panel - Tempered Glass - 66” High	EVPLFPGT6618	818	836	66	18	2 7/8
		EVPLFPGT6624	981	1009	66	24	2 7/8
		EVPLFPGT6630	1094	1123	66	30	2 7/8
		EVPLFPGT6636	1209	1243	66	36	2 7/8
		EVPLFPGT6642	1349	1385	66	42	2 7/8
		EVPLFPGT6648	1487	1529	66	48	2 7/8
		EVPLFPGT6654	1680	1727	66	54	2 7/8
		EVPLFPGT6660	1875	1925	66	60	2 7/8

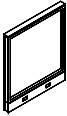
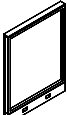
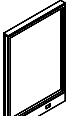

**EVPXGT - FULLY GLAZED MONOLITHIC PANEL - TEMPERED GLASS**

- Fully Glazed Monolithic Panels are incorporated into a solid steel frame.
- An aluminum low profile top cap is included.
- Stackability: Evolve panels can be increased in height in 6”H, 12”H, 18”H or 24”H increments. See Extension Modules for part numbers.
- Standard in clear (CLR) glass.
- Frosted glass (FRST) 40% upcharge.

	DESCRIPTION	PRODUCT CODE	LIST PRICE	DIMENSIONS/INCHES		
				H	W	D
	Fully Glazed Monolithic Panel - Tempered Glass - 42” High	EVPXGT4218	540	42	18	2 7/8
		EVPXGT4224	595	42	24	2 7/8
		EVPXGT4230	692	42	30	2 7/8
		EVPXGT4236	777	42	36	2 7/8
		EVPXGT4242	865	42	42	2 7/8
	Fully Glazed Monolithic Panel - Tempered Glass - 48” High	EVPXGT4818	482	48	18	2 7/8
		EVPXGT4824	616	48	24	2 7/8
		EVPXGT4830	680	48	30	2 7/8
		EVPXGT4836	839	48	36	2 7/8
		EVPXGT4842	885	48	42	2 7/8
	Fully Glazed Monolithic Panel - Tempered Glass - 54” High	EVPXGT5418	598	54	18	2 7/8
		EVPXGT5424	702	54	24	2 7/8
		EVPXGT5430	817	54	30	2 7/8
		EVPXGT5436	919	54	36	2 7/8
		EVPXGT5442	1018	54	42	2 7/8
	Fully Glazed Monolithic Panel - Tempered Glass - 66” High	EVPXGT6618	701	66	18	2 7/8
		EVPXGT6624	810	66	24	2 7/8
		EVPXGT6630	936	66	30	2 7/8
		EVPXGT6636	1052	66	36	2 7/8
		EVPXGT6642	1171	66	42	2 7/8

**EVPLXGT - FULLY GLAZED MONOLITHIC LIGHT PANEL - TEMPERED GLASS**

- Fully Glazed Monolithic Light Panels are incorporated into a solid steel frame.
- There is no base raceway in Light Panels to accommodate electrical.
- Light Panel Connectors must be used in conjunction with Light Panels.
- An aluminum low profile top cap is included.
- Stackability: Evolve panels can be increased in height in 6”H, 12”H, 18”H or 24”H increments. See Extension Modules for part numbers.
- Standard in clear (CLR) glass.
- Frosted glass (FRST) 40% upcharge.

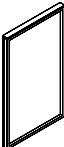
	DESCRIPTION	PRODUCT CODE	LIST PRICE	DIMENSIONS/INCHES		
				H	W	D
	Fully Glazed Monolithic Light Panel - Tempered Glass - 42" High	EVPLXGT4218	513	42	18	2 7/8
		EVPLXGT4224	565	42	24	2 7/8
		EVPLXGT4230	656	42	30	2 7/8
		EVPLXGT4236	736	42	36	2 7/8
		EVPLXGT4242	822	42	42	2 7/8
	Fully Glazed Monolithic Light Panel - Tempered Glass - 48" High	EVPLXGT4818	454	48	18	2 7/8
		EVPLXGT4824	585	48	24	2 7/8
		EVPLXGT4830	647	48	30	2 7/8
		EVPLXGT4836	799	48	36	2 7/8
		EVPLXGT4842	836	48	42	2 7/8
	Fully Glazed Monolithic Light Panel - Tempered Glass - 54"	EVPLXGT5418	571	54	18	2 7/8
		EVPLXGT5424	669	54	24	2 7/8
		EVPLXGT5430	770	54	30	2 7/8
		EVPLXGT5436	870	54	36	2 7/8
		EVPLXGT5442	966	54	42	2 7/8
	Fully Glazed Monolithic Light Panel - Tempered Glass - 66" High	EVPLXGT6618	668	66	18	2 7/8
		EVPLXGT6624	769	66	24	2 7/8
		EVPLXGT6630	890	66	30	2 7/8
		EVPLXGT6636	998	66	36	2 7/8
		EVPLXGT6642	1113	66	42	2 7/8

**EVPGT - FULLY GLAZED SEGMENTED PANEL - TEMPERED GLASS**

- Fully Glazed Segmented Panel incorporates (2) 24”H Glazed modules into a solid steel frame.
- An aluminum low profile top cap is included.
- Stackability: Evolve panels can be increased in height in 6”H, 12”H, 18”H or 24”H increments. See Extension Modules for part numbers.
- Standard in clear (CLR) glass.
- Frosted glass (FRST) 40% upcharge.

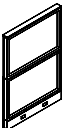
	DESCRIPTION	PRODUCT CODE	LIST PRICE	DIMENSIONS/INCHES		
				H	W	D
	Fully Glazed Segmented Panel - Tempered Glass - 54" High	EVPGT5418	764	54	18	2 7/8
		EVPGT5424	937	54	24	2 7/8
		EVPGT5430	1036	54	30	2 7/8
		EVPGT5436	1133	54	36	2 7/8
		EVPGT5442	1253	54	42	2 7/8
		EVPGT5448	1398	54	48	2 7/8
		EVPGT5454	1537	54	54	2 7/8
		EVPGT5460	1679	54	60	2 7/8

**EVPLGT - FULLY GLAZED SEGMENTED LIGHT PANEL - TEMPERED GLASS**

- Fully Glazed Segmented Light Panel incorporates (2) 24”H Glazed modules into a solid steel frame.
- There is no base raceway in Light Panels to accommodate electrical.
- Light Panel Connectors must be used in conjunction with Light Panels.
- An aluminum low profile top cap is included.
- Stackability: Evolve panels can be increased in height in 6”H, 12”H, 18”H or 24”H increments. See Extension Modules for part numbers.
- Standard in clear (CLR) glass.
- Frosted glass (FRST) 40% upcharge.

	DESCRIPTION	PRODUCT CODE	LIST PRICE	DIMENSIONS/INCHES		
				H	W	D
	Fully Glazed Segmented Light Panel Tempered Glass - 54” High	EVPLGT5418	726	54	18	2 7/8
		EVPLGT5424	892	54	24	2 7/8
		EVPLGT5430	985	54	30	2 7/8
		EVPLGT5436	1075	54	36	2 7/8
		EVPLGT5442	1194	54	42	2 7/8
		EVPLGT5448	1327	54	48	2 7/8
		EVPLGT5454	1462	54	54	2 7/8
		EVPLGT5460	1594	54	60	2 7/8

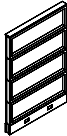
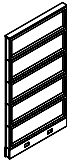

**EVPGPT - FULLY GLAZED PREMIUM PANEL - TEMPERED GLASS**

- Fully Glazed Premium Panel incorporates 12”H Glazed Modules into a solid steel frame.
- An aluminum low profile top cap is included.
- Stackability: Evolve panels can be increased in height in 6”H, 12”H, 18”H or 24”H increments. See Extension Modules for part numbers.
- Standard in clear (CLR) glass.
- Frosted glass (FRST) 40% upcharge.

	DESCRIPTION	PRODUCT CODE	LIST PRICE	DIMENSIONS/INCHES		
				H	W	D
	Fully Glazed Premium Panel - Tempered Glass - 42” High	EVPGPT4218	754	42	18	2 7/8
		EVPGPT4224	923	42	24	2 7/8
		EVPGPT4230	1021	42	30	2 7/8
		EVPGPT4236	1113	42	36	2 7/8
		EVPGPT4242	1235	42	42	2 7/8
		EVPGPT4248	1372	42	48	2 7/8
		EVPGPT4254	1512	42	54	2 7/8
		EVPGPT4260	1647	42	60	2 7/8
	Fully Glazed Premium Panel - Tempered Glass - 54” High	EVPGPT5418	953	54	18	2 7/8
		EVPGPT5424	1171	54	24	2 7/8
		EVPGPT5430	1295	54	30	2 7/8
		EVPGPT5436	1410	54	36	2 7/8
		EVPGPT5442	1568	54	42	2 7/8
		EVPGPT5448	1745	54	48	2 7/8
		EVPGPT5454	1924	54	54	2 7/8
		EVPGPT5460	2098	54	60	2 7/8
	Fully Glazed Premium Panel - Tempered Glass - 66” High	EVPGPT6618	1154	66	18	2 7/8
		EVPGPT6624	1419	66	24	2 7/8
		EVPGPT6630	1570	66	30	2 7/8
		EVPGPT6636	1707	66	36	2 7/8
		EVPGPT6642	1895	66	42	2 7/8
		EVPGPT6648	2111	66	48	2 7/8
		EVPGPT6654	2329	66	54	2 7/8
		EVPGPT6660	2546	66	60	2 7/8

**EVPLGPT - FULLY GLAZED PREMIUM LIGHT PANEL - TEMPERED GLASS**

- Fully Glazed Premium Light Panel incorporates 12"H Glazed Modules into a solid steel frame.
- There is no base raceway in Light Panels to accommodate electrical.
- Light Panel Connectors must be used in conjunction with Light Panels.
- An aluminum low profile top cap is included.
- Stackability: Evolve panels can be increased in height in 6"H, 12"H, 18"H or 24"H increments. See Extension Modules for part numbers.
- Standard in clear (CLR) glass.
- Frosted glass (FRST) 40% upcharge.

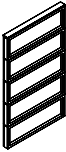
	DESCRIPTION	PRODUCT CODE	LIST PRICE	DIMENSIONS/INCHES		
				H	W	D
	Fully Glazed Premium Light Panel - Tempered Glass - 42" High	EVPLGPT4218	730	42	18	2 7/8
		EVPLGPT4224	893	42	24	2 7/8
		EVPLGPT4230	988	42	30	2 7/8
		EVPLGPT4236	1080	42	36	2 7/8
		EVPLGPT4242	1198	42	42	2 7/8
		EVPLGPT4248	1331	42	48	2 7/8
		EVPLGPT4254	1467	42	54	2 7/8
		EVPLGPT4260	1598	42	60	2 7/8
	Fully Glazed Premium Light Panel - Tempered Glass - 54" High	EVPLGPT5418	927	54	18	2 7/8
		EVPLGPT5424	1137	54	24	2 7/8
		EVPLGPT5430	1253	54	30	2 7/8
		EVPLGPT5436	1370	54	36	2 7/8
		EVPLGPT5442	1522	54	42	2 7/8
		EVPLGPT5448	1692	54	48	2 7/8
		EVPLGPT5454	1863	54	54	2 7/8
		EVPLGPT5460	2033	54	60	2 7/8
	Fully Glazed Premium Light Panel - Tempered Glass - 66" High	EVPLGPT6618	1122	66	18	2 7/8
		EVPLGPT6624	1375	66	24	2 7/8
		EVPLGPT6630	1524	66	30	2 7/8
		EVPLGPT6636	1655	66	36	2 7/8
		EVPLGPT6642	1841	66	42	2 7/8
		EVPLGPT6648	2048	66	48	2 7/8
		EVPLGPT6654	2257	66	54	2 7/8
		EVPLGPT6660	2469	66	60	2 7/8

**EVPHSG - RECEPTION PANEL LAMINATE**

- Reception panel incorporates glazed module and pass thru module within steel frame. Glazing is clear only.
- 6" H or 12" H pass thru with sliding glass door module.
- 24" H Laminate bottom module.
- Aluminum low profile top is included.
- Stackability: Evolve panels can be increased in height in 6", 12", 24" increments. See module listing for part numbers.

	DESCRIPTION	PRODUCT CODE	LIST PRICE	DIMENSIONS/INCHES		
				H	W	D
	Reception Panel with 12" H Pass Thru	EVPHSG2M6636	1546	66	36	2 7/8
		EVPHSG2M6642	1671	66	42	2 7/8
		EVPHSG2M6648	1807	66	48	2 7/8

**EVPHSG - RECEPTION PANEL LAMINATE**

- Reception panel incorporates glazed module and pass thru module within steel frame. Glazing is clear only.
- 6" H pass thru with sliding glass door module.
- 30" H Laminate bottom module.
- Aluminum low profile top is included.
- Stackability: Evolve panels can be increased in height in 6", 12", 24" increments. See module listing for part numbers.

	DESCRIPTION	PRODUCT CODE	LIST PRICE	DIMENSIONS/INCHES		
				H	W	D
	Reception Panel with 6" H Pass Thru	EVPHSG3M6636	1604	66	36	2 7/8
		EVPHSG3M6642	1724	66	42	2 7/8
		EVPHSG3M6648	1888	66	48	2 7/8

**EVPHSG - RECEPTION PANEL LAMINATE**

- Reception panel incorporates glazed module and pass thru module within steel frame. Glazing is clear only.
- 6" H or 12" H pass thru with sliding glass door module.
- 24" H Laminate bottom module.
- Aluminum low profile top is included.
- Stackability: Evolve panels can be increased in height in 6", 12", 24" increments. See module listing for part numbers.

	DESCRIPTION	PRODUCT CODE	LIST PRICE	DIMENSIONS/INCHES		
				H	W	D
	Reception Panel with 6" H Pass Thru	EVPHSG5M6636	1581	66	36	2 7/8
		EVPHSG5M6642	1707	66	42	2 7/8
		EVPHSG5M6648	1843	66	48	2 7/8

**EVPHSG - RECEPTION PANEL FABRIC**

- Reception panel incorporates glazed module and pass thru module within steel frame. Glazing is clear only.
- 6" H or 12" H pass thru with sliding glass door module.
- 24" H Fabric bottom module.
- Aluminum low profile top is included.
- Stackability: Evolve panels can be increased in height in 6", 12", 24" increments. See module listing for part numbers.

	DESCRIPTION	PRODUCT CODE	LIST PRICE		DIMENSIONS/INCHES		
			Gr1	Gr2	H	W	D
	Reception Panel with 12" H Pass Thru	EVPHSG2M6636	1382	1412	66	36	2 7/8
		EVPHSG2M6642	1522	1560	66	42	2 7/8
		EVPHSG2M6648	1676	1714	66	48	2 7/8

**EVPHSG - RECEPTION PANEL FABRIC**

- Reception panel incorporates glazed module and pass thru module within steel frame. Glazing is clear only.
- 6" H pass thru with sliding glass door module.
- 30" H Fabric bottom module.
- Aluminum low profile top is included.
- Stackability: Evolve panels can be increased in height in 6", 12", 24" increments. See module listing for part numbers.

	DESCRIPTION	PRODUCT CODE	LIST PRICE		DIMENSIONS/INCHES		
			Gr1	Gr2	H	W	D
	Reception Panel with 6" H Pass Thru	EVPHSG3M6636	1458	1490	66	36	2 7/8
		EVPHSG3M6642	1589	1627	66	42	2 7/8
		EVPHSG3M6648	1724	1762	66	48	2 7/8

**EVPHSG - RECEPTION PANEL FABRIC**

- Reception panel incorporates glazed module and pass thru module within steel frame. Glazing is clear only.
- 6" H or 12" H pass thru with sliding glass door module.
- 24" H Fabric bottom module.
- Aluminum low profile top is included.
- Stackability: Evolve panels can be increased in height in 6", 12", 24" increments. See module listing for part numbers.

	DESCRIPTION	PRODUCT CODE	LIST PRICE		DIMENSIONS/INCHES		
			Gr1	Gr2	H	W	D
	Reception Panel with 6" H Pass Thru	EVPHSG5M6636	1405	1437	66	36	2 7/8
		EVPHSG5M6642	1565	1601	66	42	2 7/8
		EVPHSG5M6648	1722	1760	66	48	2 7/8

**EVSLs - LAMINATED SHELF FOR RECEPTION PANEL**

- Laminated Wood Shelf Panel Mounted.
- Shelf thickness 1".
- Available in LP.
- Includes attachment hardware.

	DESCRIPTION	PRODUCT CODE	LIST PRICE	DIMENSIONS/INCHES		
				H	W	D
	Reception Panel Shelf	EVSLs1218	277	1.125	18	12
		EVSLs1224	297	1.125	24	12
		EVSLs1230	315	1.125	30	12
		EVSLs1236	335	1.125	36	12
		EVSLs1242	354	1.125	42	12
		EVSLs1248	374	1.125	48	12

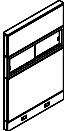
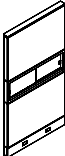
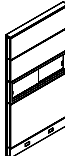

**EVPFSG - PASS-THRU SLIDING DOOR GLAZED PANEL - TEMPERED GLASS**

- Pass-Thru Sliding Door Glazed Panel incorporates fabric modules on upper and lower positions, with Middle 12”H Pass-Thru Sliding Door module, into a solid steel frame.
- Tracks for Sliding glass door available in Tungsten only.
- Opposite sides of each panel may have a different fabric within the same grade at no upcharge.
- If different grades of fabric are used on one panel, the entire panel must be priced at highest grade.
- An aluminum low profile top cap is included.
- Stackability: Evolve panels can be increased in height in 6”H, 12”H, 18”H or 24”H increments. See Extension Modules for part numbers.
- Standard in clear (CLR) glass.
- Frosted glass (FRST) 20% upcharge.

	DESCRIPTION	PRODUCT CODE	LIST PRICE		DIMENSIONS/INCHES		
			Gr1	Gr2	H	W	D
	Pass-Thru Sliding Door Glazed Panel - Tempered Glass - 54” High	EVPFSG5424	768	802	54	24	2 7/8
		EVPFSG5430	867	909	54	30	2 7/8
		EVPFSG5436	975	1025	54	36	2 7/8
		EVPFSG5442	1094	1149	54	42	2 7/8
		EVPFSG5448	1189	1248	54	48	2 7/8
		EVPFSG5454	1334	1401	54	54	2 7/8
		EVPFSG5460	1474	1547	54	60	2 7/8
	Pass-Thru Sliding Door Glazed Panel - Tempered Glass - 66” High	EVPFSG6624	830	877	66	24	2 7/8
		EVPFSG6630	947	1000	66	30	2 7/8
		EVPFSG6636	1059	1123	66	36	2 7/8
		EVPFSG6642	1197	1266	66	42	2 7/8
		EVPFSG6648	1298	1377	66	48	2 7/8
		EVPFSG6654	1450	1537	66	54	2 7/8
		EVPFSG6660	1632	1693	66	60	2 7/8
	Pass-Thru Sliding Door Glazed Panel - Tempered Glass - 66” High	EVPFPSG6624	830	877	66	24	2 7/8
		EVPFPSG6630	947	1000	66	30	2 7/8
		EVPFPSG6636	1059	1123	66	36	2 7/8
		EVPFPSG6642	1197	1266	66	42	2 7/8
		EVPFPSG6648	1298	1377	66	48	2 7/8
		EVPFPSG6654	1450	1537	66	54	2 7/8
		EVPFPSG6660	1632	1693	66	60	2 7/8

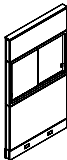

**EVPFSGX - FABRIC GLAZED PASS-THRU SLIDING DOOR PANEL - TEMPERED GLASS**

- Pass-Thru Sliding Door Glazed Panel incorporates fabric modules with 12”H or 24”H Pass-Thru Sliding Door module, into a solid steel frame.
- Tracks for Sliding glass door available in Tungsten only.
- Opposite sides of each panel may have a different fabric within the same grade at no upcharge.
- If different grades of fabric are used on one panel, the entire panel must be priced at highest grade.
- An aluminum low profile top cap is included.
- Stackability: Evolve panels can be increased in height in 6”H, 12”H, 18”H or 24”H increments. See Extension Modules for part numbers.
- Standard in clear (CLR) glass.
- Frosted glass (FRST) 20% upcharge.

	DESCRIPTION	PRODUCT CODE	LIST PRICE		DIMENSIONS/INCHES		
			Gr1	Gr2	H	W	D
	Fabric Glazed Pass-Thru Sliding Door Panel - Tempered Glass - 42” High	EVPFSGX4224	595	621	42	24	2 7/8
		EVPFSGX4230	674	702	42	30	2 7/8
		EVPFSGX4236	752	786	42	36	2 7/8
		EVPFSGX4242	835	873	42	42	2 7/8
		EVPFSGX4248	914	955	42	48	2 7/8
		EVPFSGX4254	1021	1065	42	54	2 7/8
		EVPFSGX4260	1127	1177	42	60	2 7/8
	Fabric Glazed Pass-Thru Sliding Door Panel - Tempered Glass - 54” High	EVPFSGX5424	647	673	54	24	2 7/8
		EVPFSGX5430	752	781	54	30	2 7/8
		EVPFSGX5436	852	886	54	36	2 7/8
		EVPFSGX5442	952	988	54	42	2 7/8
		EVPFSGX5448	1038	1079	54	48	2 7/8
		EVPFSGX5454	1203	1247	54	54	2 7/8
		EVPFSGX5460	1366	1419	54	60	2 7/8
	Fabric Glazed Pass-Thru Sliding Door Panel - Tempered Glass - 66” High	EVPFSGX6624	821	857	66	24	2 7/8
		EVPFSGX6630	947	988	66	30	2 7/8
		EVPFSGX6636	1078	1126	66	36	2 7/8
		EVPFSGX6642	1211	1268	66	42	2 7/8
		EVPFSGX6648	1316	1377	66	48	2 7/8
		EVPFSGX6654	1513	1580	66	54	2 7/8
		EVPFSGX6660	1712	1783	66	60	2 7/8

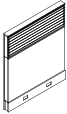
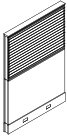

**EVPF1S - SLATWALL PANEL - SINGLE SIDED**

- Slatwall Panel incorporates fabric modules with a single 12”H or 24”H top position slatwall module, into a solid steel frame.
- 66”H panel can be configured with either a 24”H slatwall module at the top or a 12”H slatwall at the middle Position (EVPF1S66xxM)
- Opposite side is fabric covered.
- Slatwall is made of aluminum.
- Accessories can be used on slatwall modules. Please see accessory section for additional details.
- Opposite sides of each panel may have a different fabric within the same grade at no upcharge.
- If different grades of fabric are used on one panel, the entire panel must be priced at highest grade.
- An aluminum low profile top cap is included.
- Stackability: Evolve panels can be increased in height in 6”H, 12”H, 18”H or 24”H increments. See Extension Modules for part numbers.

	DESCRIPTION	PRODUCT CODE	LIST PRICE		DIMENSIONS/INCHES		
			Gr1	Gr2	H	W	D
	Slatwall Panel - Single Sided - 42” High	EVPF1S4218	562	588	42	18	2 7/8
		EVPF1S4224	670	702	42	24	2 7/8
		EVPF1S4230	786	820	42	30	2 7/8
		EVPF1S4236	898	937	42	36	2 7/8
		EVPF1S4242	1021	1065	42	42	2 7/8
		EVPF1S4248	1110	1162	42	48	2 7/8
		EVPF1S4254	1233	1288	42	54	2 7/8
		EVPF1S4260	1349	1412	42	60	2 7/8
	Slatwall Panel - Single Sided - 54” High	EVPF1S5418	662	689	54	18	2 7/8
		EVPF1S5424	797	831	54	24	2 7/8
		EVPF1S5430	930	971	54	30	2 7/8
		EVPF1S5436	1070	1117	54	36	2 7/8
		EVPF1S5442	1209	1266	54	42	2 7/8
		EVPF1S5448	1318	1381	54	48	2 7/8
		EVPF1S5454	1469	1536	54	54	2 7/8
		EVPF1S5460	1615	1682	54	60	2 7/8
	Slatwall Panel - Single Sided - 66” High	EVPF1S6618	840	869	66	18	2 7/8
		EVPF1S6624	1008	1056	66	24	2 7/8
		EVPF1S6630	1182	1237	66	30	2 7/8
		EVPF1S6636	1362	1419	66	36	2 7/8
		EVPF1S6642	1548	1618	66	42	2 7/8
		EVPF1S6648	1684	1754	66	48	2 7/8
		EVPF1S6654	1875	1950	66	54	2 7/8
		EVPF1S6660	2066	2148	66	60	2 7/8
	Slat Wall Panel - Single Sided - Middle Module - 66” High	EVPF1S6618M	819	858	66	18	2 7/8
		EVPF1S6624M	985	1035	66	24	2 7/8
		EVPF1S6630M	1149	1208	66	30	2 7/8
		EVPF1S6636M	1322	1392	66	36	2 7/8
		EVPF1S6642M	1505	1584	66	42	2 7/8
		EVPF1S6648M	1639	1727	66	48	2 7/8
		EVPF1S6654M	1822	1920	66	54	2 7/8
		EVPF1S6660M	2005	2114	66	60	2 7/8

**EVPLF1S - SLATWALL LIGHT PANEL - SINGLE SIDED**

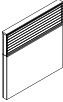
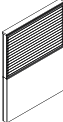
- Slatwall Light Panel incorporates fabric modules with a single 12”H or 24”H top position slatwall module, into a solid steel frame.
- 66”H panel can be configured with either a 24”H slatwall module at the top or a 12”H slatwall at the middle Position (EVPLF1S66xxM)
- Opposite side is fabric covered
- Slatwall is made of aluminum.
- Accessories can be used on slatwall modules. Please see accessory section for additional details.
- There is no base raceway in Light Panels to accommodate electrical.
- Light Panel Connectors must be used in conjunction with Light Panels.
- Opposite sides of each panel may have a different fabric within the same grade at no upcharge.
- If different grades of fabric are used on one panel, the entire panel must be priced at highest grade.
- An aluminum low profile top cap is included.
- Stackability: Evolve panels can be increased in height in 6”H, 12”H, 18”H or 24”H increments. See Extension Modules for part numbers.

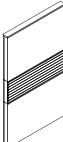
	DESCRIPTION	PRODUCT CODE	LIST PRICE		DIMENSIONS/INCHES		
			Gr1	Gr2	H	W	D
	Slatwall Light Panel - Single Sided- 42” High	EVPLF1S4218	549	575	42	18	2 7/8
		EVPLF1S4224	656	688	42	24	2 7/8
		EVPLF1S4230	769	803	42	30	2 7/8
		EVPLF1S4236	882	920	42	36	2 7/8
		EVPLF1S4242	998	1042	42	42	2 7/8
		EVPLF1S4248	1089	1139	42	48	2 7/8
		EVPLF1S4254	1206	1261	42	54	2 7/8
	EVPLF1S4260	1322	1385	42	60	2 7/8	
	Slatwall Light Panel - Single Sided - 54” High	EVPLF1S5418	648	674	54	18	2 7/8
		EVPLF1S5424	782	815	54	24	2 7/8
		EVPLF1S5430	914	955	54	30	2 7/8
		EVPLF1S5436	1047	1094	54	36	2 7/8
		EVPLF1S5442	1185	1240	54	42	2 7/8
		EVPLF1S5448	1295	1356	54	48	2 7/8
		EVPLF1S5454	1440	1506	54	54	2 7/8
	EVPLF1S5460	1583	1649	54	60	2 7/8	
	Slatwall Light Panel - Single Sided - 66” High	EVPLF1S6618	824	853	66	18	2 7/8
		EVPLF1S6624	988	1035	66	24	2 7/8
		EVPLF1S6630	1157	1210	66	30	2 7/8
		EVPLF1S6636	1334	1391	66	36	2 7/8
		EVPLF1S6642	1517	1586	66	42	2 7/8
		EVPLF1S6648	1648	1718	66	48	2 7/8
		EVPLF1S6654	1834	1909	66	54	2 7/8
	EVPLF1S6660	2025	2106	66	60	2 7/8	
	Slatwall Light Panel - Single Sided - Middle Module - 66” High	EVPLF1S6618M	800	838	66	18	2 7/8
		EVPLF1S6624M	966	1014	66	24	2 7/8
		EVPLF1S6630M	1127	1184	66	30	2 7/8
		EVPLF1S6636M	1298	1367	66	36	2 7/8
		EVPLF1S6642M	1475	1554	66	42	2 7/8
		EVPLF1S6648M	1605	1692	66	48	2 7/8
		EVPLF1S6654M	1786	1883	66	54	2 7/8
	EVPLF1S6660M	1964	2068	66	60	2 7/8	

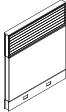
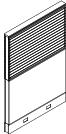
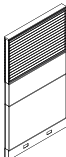
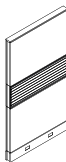

**EVPF2S - SLATWALL PANEL - DOUBLE SIDED**

- Slatwall Panel incorporates fabric modules with a single 12”H or 24”H top position slatwall module, into a solid steel frame.
- 66”H panel can be configured with either a 24”H slatwall module at the top or a 12”H slatwall at the middle Position (EVPF2S66xxM)
- Slatwall module has slatwall on both sides.
- Slatwall is made of aluminum.
- Accessories can be used on slatwall modules. Please see accessory section for additional details.
- Opposite sides of each panel may have a different fabric within the same grade at no upcharge.
- If different grades of fabric are used on one panel, the entire panel must be priced at highest grade.
- An aluminum low profile top cap is included.
- Stackability: Evolve panels can be increased in height in 6”H, 12”H, 18”H or 24”H increments. See Extension Modules for part numbers.

	DESCRIPTION	PRODUCT CODE	LIST PRICE		DIMENSIONS/INCHES		
			Gr1	Gr2	H	W	D
	Slatwall Panel - Double Sided - 42” High	EVPF2S4218	630	650	42	18	2 7/8
		EVPF2S4224	760	787	42	24	2 7/8
		EVPF2S4230	894	923	42	30	2 7/8
		EVPF2S4236	1043	1077	42	36	2 7/8
		EVPF2S4242	1189	1227	42	42	2 7/8
		EVPF2S4248	1331	1372	42	48	2 7/8
		EVPF2S4254	1465	1509	42	54	2 7/8
		EVPF2S4260	1593	1646	42	60	2 7/8
	Slatwall Panel - Double Sided - 54” High	EVPF2S5418	735	755	54	18	2 7/8
		EVPF2S5424	899	926	54	24	2 7/8
		EVPF2S5430	1062	1091	54	30	2 7/8
		EVPF2S5436	1240	1274	54	36	2 7/8
		EVPF2S5442	1418	1456	54	42	2 7/8
		EVPF2S5448	1592	1633	54	48	2 7/8
		EVPF2S5454	1751	1795	54	54	2 7/8
		EVPF2S5460	1906	1958	54	60	2 7/8
	Slatwall Panel - Double Sided - 66” High	EVPF2S6618	952	978	66	18	2 7/8
		EVPF2S6624	1171	1207	66	24	2 7/8
		EVPF2S6630	1386	1427	66	30	2 7/8
		EVPF2S6636	1609	1656	66	36	2 7/8
		EVPF2S6642	1842	1897	66	42	2 7/8
		EVPF2S6648	2066	2125	66	48	2 7/8
		EVPF2S6654	2281	2345	66	54	2 7/8
		EVPF2S6660	2488	2562	66	60	2 7/8
	Slatwall Panel - Double Sided - Middle Module - 66” High	EVPF2S6618M	927	963	66	18	2 7/8
		EVPF2S6624M	1138	1185	66	24	2 7/8
		EVPF2S6630M	1349	1402	66	30	2 7/8
		EVPF2S6636M	1566	1625	66	36	2 7/8
		EVPF2S6642M	1788	1857	66	42	2 7/8
		EVPF2S6648M	2005	2085	66	48	2 7/8
		EVPF2S6654M	2218	2305	66	54	2 7/8
		EVPF2S6660M	2422	2517	66	60	2 7/8

**EVPLF2S - SLATWALL LIGHT PANEL - DOUBLE SIDED**

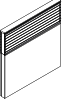
- Slatwall Light Panel incorporates fabric modules with a single 12”H or 24”H top position slatwall module, into a solid steel frame.
- 66”H panel can be configured with either a 24”H slatwall module at the top or a 12”H slatwall at the middle Position (EVPLF2S66xxM)
- Slatwall module has slatwall on both sides.
- Slatwall is made of aluminum.
- Accessories can be used on slatwall modules. Please see accessory section for additional details.
- There is no base raceway in Light Panels to accommodate electrical.
- Light Panel Connectors must be used in conjunction with Light Panels.
- Opposite sides of each panel may have a different fabric within the same grade at no upcharge.
- If different grades of fabric are used on one panel, the entire panel must be priced at highest grade.
- An aluminum low profile top cap is included.
- Stackability: Evolve panels can be increased in height in 6”H, 12”H, 18”H or 24”H increments.
- See Extension Modules for part numbers.

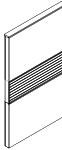
	DESCRIPTION	PRODUCT CODE	LIST PRICE		DIMENSIONS/INCHES		
			Gr1	Gr2	H	W	D
	Slatwall Light Panel - Double Sided - 42" High	EVPLF2S4218	617	635	42	18	2 7/8
		EVPLF2S4224	745	771	42	24	2 7/8
		EVPLF2S4230	879	906	42	30	2 7/8
		EVPLF2S4236	1023	1057	42	36	2 7/8
		EVPLF2S4242	1165	1203	42	42	2 7/8
		EVPLF2S4248	1305	1344	42	48	2 7/8
		EVPLF2S4254	1435	1477	42	54	2 7/8
		EVPLF2S4260	1559	1612	42	60	2 7/8
	Slatwall Light Panel - Double Sided - 54" High	EVPLF2S5418	722	740	54	18	2 7/8
		EVPLF2S5424	885	908	54	24	2 7/8
		EVPLF2S5430	1043	1071	54	30	2 7/8
		EVPLF2S5436	1215	1248	54	36	2 7/8
		EVPLF2S5442	1387	1423	54	42	2 7/8
		EVPLF2S5448	1558	1599	54	48	2 7/8
		EVPLF2S5454	1717	1759	54	54	2 7/8
		EVPLF2S5460	1869	1921	54	60	2 7/8
	Slatwall Light Panel - Double Sided - 66" High	EVPLF2S6618	934	961	66	18	2 7/8
		EVPLF2S6624	1148	1184	66	24	2 7/8
		EVPLF2S6630	1362	1401	66	30	2 7/8
		EVPLF2S6636	1577	1624	66	36	2 7/8
		EVPLF2S6642	1806	1859	66	42	2 7/8
		EVPLF2S6648	2025	2082	66	48	2 7/8
		EVPLF2S6654	2233	2297	66	54	2 7/8
		EVPLF2S6660	2440	2511	66	60	2 7/8
	Slatwall Light Panel - Double Sided - 66" High	EVPLF2S6618M	899	941	66	18	2 7/8
		EVPLF2S6624M	1115	1162	66	24	2 7/8
		EVPLF2S6630M	1322	1375	66	30	2 7/8
		EVPLF2S6636M	1534	1592	66	36	2 7/8
		EVPLF2S6642M	1753	1820	66	42	2 7/8
		EVPLF2S6648M	1964	2039	66	48	2 7/8
		EVPLF2S6654M	2173	2260	66	54	2 7/8
		EVPLF2S6660M	2375	2470	66	60	2 7/8

**EVPBSFA - FRAMELESS SLATWALL BELTLINE POWERED PANEL - DOUBLE SIDED ONLY**

- Frameless Slatwall Beltline Powered Panel incorporates fabric modules with a single 6”H slatwall module above a power beltline raceway, into a solid steel frame.
- Slatwall module has slatwall on both sides only, and is not available Single Sided.
- Slatwall is made of aluminum.
- Slatwall is not encompassed within a frame.
- A Chimney Panel is required to run electric and data from the base to belt
- 6”H power beltline raceway, to accommodate electrical, is metal with knockouts on both sides.
- Beltline Connectors must be used in conjunction with beltline panels.
- Accessories can be used on slatwall modules. Please see accessory section for additional details.
- Opposite sides of each panel may have a different fabric within the same grade at no upcharge.
- If different grades of fabric are used on one panel, the entire panel must be priced at highest grade.
- An aluminum low profile top cap is included.
- Stackability: Evolve panels can be increased in height in 6”H, 12”H, 18”H or 24”H increments. See Extension Modules for part numbers.

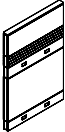
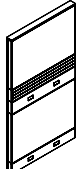
	DESCRIPTION	PRODUCT CODE	LIST PRICE		DIMENSIONS/INCHES		
			Gr1	Gr2	H	W	D
	Frameless Slatwall Beltline Powered Panel - Double Sided Only - 42” High	EVPBSFA4224	557	583	42	24	2 7/8
		EVPBSFA4230	648	675	42	30	2 7/8
		EVPBSFA4236	756	788	42	36	2 7/8
		EVPBSFA4242	850	888	42	42	2 7/8
		EVPBSFA4248	936	977	42	48	2 7/8
		EVPBSFA4254	1029	1073	42	54	2 7/8
		EVPBSFA4260	1118	1168	42	60	2 7/8
	Frameless Slatwall Beltline Powered Panel - Double Sided Only - 54” High	EVPBSFA5424	703	737	54	24	2 7/8
		EVPBSFA5430	819	860	54	30	2 7/8
		EVPBSFA5436	966	1013	54	36	2 7/8
		EVPBSFA5442	1080	1133	54	42	2 7/8
		EVPBSFA5448	1189	1250	54	48	2 7/8
		EVPBSFA5454	1292	1359	54	54	2 7/8
		EVPBSFA5460	1406	1479	54	60	2 7/8
	Frameless Slatwall Beltline Powered Panel - Double Sided Only - 66” High	EVPBSFA6624	785	827	66	24	2 7/8
		EVPBSFA6630	909	964	66	30	2 7/8
		EVPBSFA6636	1050	1111	66	36	2 7/8
		EVPBSFA6642	1180	1250	66	42	2 7/8
		EVPBSFA6648	1302	1381	66	48	2 7/8
		EVPBSFA6654	1427	1514	66	54	2 7/8
		EVPBSFA6660	1550	1644	66	60	2 7/8

**EVPBLSFA - FRAMELESS SLATWALL BELTLINE POWERED LIGHT PANEL - DOUBLE SIDED ONLY**

- Frameless Slatwall Beltline Powered Light Panel incorporates fabric modules with a single 6”H slatwall module above a power beltline raceway, into a solid steel frame.
- Slatwall module has slatwall on both sides only, and is not available Single Sided.
- Slatwall is made of aluminum.
- Slatwall is not encompassed within a frame.
- 6”H power beltline raceway, to accommodate electrical, is metal with knockouts on both sides.
- There is no base raceway in Light Panels to accommodate electrical.
- Light Beltline Panel Connectors must be used in conjunction with Light Beltline Panels.
- Accessories can be used on slatwall modules. Please see accessory section for additional details.
- Opposite sides of each panel may have a different fabric within the same grade at no upcharge.
- If different grades of fabric are used on one panel, the entire panel must be priced at highest grade.
- An aluminum low profile top cap is included.
- Stackability: Evolve panels can be increased in height in 6”H, 12”H, 18”H or 24”H increments. See Extension Modules for part numbers.

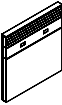
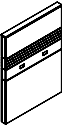
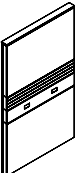
	DESCRIPTION	PRODUCT CODE	LIST PRICE		DIMENSIONS/INCHES		
			Gr1	Gr2	H	W	D
	Frameless Slatwall Beltline Powered Light Panel - Double Sided Only - 42” High	EVPBLSFA4224	532	558	42	24	2 7/8
		EVPBLSFA4230	617	645	42	30	2 7/8
		EVPBLSFA4236	722	754	42	36	2 7/8
		EVPBLSFA4242	806	842	42	42	2 7/8
		EVPBLSFA4248	893	934	42	48	2 7/8
		EVPBLSFA4254	984	1028	42	54	2 7/8
		EVPBLSFA4260	1069	1117	42	60	2 7/8
	Frameless Slatwall Beltline Powered Light Panel - Double Sided Only - 54” High	EVPBLSFA5424	654	688	54	24	2 7/8
		EVPBLSFA5430	714	801	54	30	2 7/8
		EVPBLSFA5436	852	946	54	36	2 7/8
		EVPBLSFA5442	1006	1059	54	42	2 7/8
		EVPBLSFA5448	1107	1168	54	48	2 7/8
		EVPBLSFA5454	1201	1267	54	54	2 7/8
		EVPBLSFA5460	1310	1381	54	60	2 7/8
	Frameless Slatwall Beltline Powered Light Panel - Double Sided Only - 66” High	EVPBLSFA6624	726	767	66	24	2 7/8
		EVPBLSFA6630	839	894	66	30	2 7/8
		EVPBLSFA6636	974	1035	66	36	2 7/8
		EVPBLSFA6642	1090	1161	66	42	2 7/8
		EVPBLSFA6648	1203	1282	66	48	2 7/8
		EVPBLSFA6654	1321	1407	66	54	2 7/8
		EVPBLSFA6660	1435	1529	66	60	2 7/8

**EVPBCSFA - FRAMELESS SLATWALL BELTLINE POWERED CHIMNEY PANEL - DOUBLE SIDED ONLY**

- Frameless Slatwall Beltline Powered Chimney Panel incorporates fabric modules with a single 6”H slatwall module above a power beltline raceway, into a solid steel frame.
- Slatwall module has slatwall on both sides only, and is not available Single Sided.
- Slatwall is made of aluminum.
- Slatwall is not encompassed within a frame.
- A Chimney Panel is required to run electric and data from the base to belt.
- Separate electric harness required to go from base to belt (see EVE8CPCP).
- 6”H power beltline raceway, to accommodate electrical, is metal with knockouts on both sides.
- Beltline Connectors must be used in conjunction with beltline panels.
- Accessories can be used on slatwall modules. Please see accessory section for additional details.
- Opposite sides of each panel may have a different fabric within the same grade at no upcharge.
- If different grades of fabric are used on one panel, the entire panel must be priced at highest grade.
- An aluminum low profile top cap is included.
- Stackability: Evolve panels can be increased in height in 6”H, 12”H, 18”H or 24”H increments. See Extension Modules for part numbers.

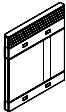
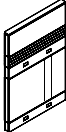
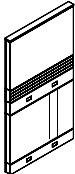
	DESCRIPTION	PRODUCT CODE	LIST PRICE		DIMENSIONS/INCHES		
			Gr1	Gr2	H	W	D
	Frameless Slatwall Beltline Powered -	EVPBCSFA4236	835	867	42	36	2 7/8
	Chimney Panel - Double Sided Only - 42” High	EVPBCSFA4242	929	967	42	42	2 7/8
	Frameless Slatwall Beltline Powered -	EVPBCSFA5436	1047	1094	54	36	2 7/8
	Chimney Panel - Double Sided Only - 54” High	EVPBCSFA5442	1161	1214	54	42	2 7/8
	Frameless Slatwall Beltline Powered -	EVPBCSFA6636	1134	1195	66	36	2 7/8
	Chimney Panel - Double Sided Only - 66” High	EVPBCSFA6642	1259	1329	66	42	2 7/8

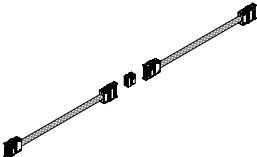

**EVE8CPCP - CHIMNEY PANEL JUMPER CABLE KIT**

- Contains two (2) 17” flexible harnesses and one (1) “I” connector.
- Used to connect electric from the base to the beltline raceway in Beltline Powered Chimney panel.
- Must use in conjunction with base power distribution harness and beltline power distribution harness (sold separately)

	DESCRIPTION	PRODUCT CODE	LIST PRICE	DIMENSIONS/INCHES		
				H	W	D
	Chimney Panel Jumper Cable Kit	EVE8CPCP	365			



**EVPF1W - WRITE BOARD PANEL - SINGLE SIDED**

- Write Board Panel incorporates fabric modules with a single 24”H top position write board module, into a solid steel frame.
- Use erasable writeboard markers only.
- Fabric covered modules are tackable and acoustical.
- Opposite sides of each panel may have a different fabric within the same grade at no upcharge.
- If different grades of fabric are used on one panel, the entire panel must be priced at highest grade.
- An aluminum low profile top cap is included.
- Stackability: Evolve panels can be increased in height in 6”H, 12”H, 18”H or 24”H increments. See Extension Modules for part numbers.

	DESCRIPTION	PRODUCT CODE	LIST PRICE		DIMENSIONS/INCHES		
			Gr1	Gr2	H	W	D
	Write Board Panel - Single Sided - 54” High	EVPF1W5418	548	568	54	18	2 7/8
		EVPF1W5424	679	713	54	24	2 7/8
		EVPF1W5430	820	861	54	30	2 7/8
		EVPF1W5436	907	955	54	36	2 7/8
		EVPF1W5442	1021	1076	54	42	2 7/8
		EVPF1W5448	1150	1211	54	48	2 7/8
		EVPF1W5454	1278	1322	54	54	2 7/8
		EVPF1W5460	1408	1479	54	60	2 7/8
	Write Board Panel - Single Sided - 66” High	EVPF1W6618	695	724	66	18	2 7/8
		EVPF1W6624	856	900	66	24	2 7/8
		EVPF1W6630	1017	1069	66	30	2 7/8
		EVPF1W6636	1133	1196	66	36	2 7/8
		EVPF1W6642	1279	1349	66	42	2 7/8
		EVPF1W6648	1429	1508	66	48	2 7/8
		EVPF1W6654	1588	1679	66	54	2 7/8
		EVPF1W6660	1752	1849	66	60	2 7/8



**EVPLF1W - WRITE BOARD LIGHT PANEL - SINGLE SIDED**

- Write Board Panel incorporates fabric modules with a single 24”H top position write board module, into a solid steel frame.
- Use erasable writeboard markers only.
- Fabric covered modules are tackable and acoustical.
- Opposite sides of each panel may have a different fabric within the same grade at no upcharge.
- If different grades of fabric are used on one panel, the entire panel must be priced at highest grade.
- Light panel connectors must be used for Light Panels.
- There is no base raceway in Light Panels to accommodate electrical.
- An aluminum low profile top cap is included.
- Stackability: Evolve panels can be increased in height in 6”H, 12”H, 18”H or 24”H increments. See Extension Modules for part numbers.

	DESCRIPTION	PRODUCT CODE	LIST PRICE		DIMENSIONS/INCHES		
			Gr1	Gr2	H	W	D
	Write Board Light Panel - Single Sided - 54” High	EVPLF1W5418	532	553	54	18	2 7/8
		EVPLF1W5424	659	693	54	18	2 7/8
		EVPLF1W5430	796	835	54	18	2 7/8
		EVPLF1W5436	880	924	54	18	2 7/8
		EVPLF1W5442	988	1041	54	18	2 7/8
		EVPLF1W5448	1115	1174	54	18	2 7/8
		EVPLF1W5454	1242	1283	54	18	2 7/8
		EVPLF1W5460	1366	1436	54	18	2 7/8
	Write Board Light Panel - Single Sided - 66” High	EVPLF1W6618	677	704	66	18	2 7/8
		EVPLF1W6624	830	872	66	24	2 7/8
		EVPLF1W6630	985	1035	66	30	2 7/8
		EVPLF1W6636	1094	1155	66	36	2 7/8
		EVPLF1W6642	1243	1310	66	42	2 7/8
		EVPLF1W6648	1385	1460	66	48	2 7/8
		EVPLF1W6654	1538	1626	66	54	2 7/8
		EVPLF1W6660	1699	1794	66	60	2 7/8



**EVPF2W - WRITE BOARD PANEL - DOUBLE SIDED**

- Write Board Panel incorporates fabric modules with a single 24”H top position write board module, into a solid steel frame.
- Use erasable writeboard markers only.
- Opposite sides of each panel may have a different fabric within the same grade at no upcharge.
- If different grades of fabric are used on one panel, the entire panel must be priced at highest grade.
- An aluminum low profile top cap is included.
- Stackability: Evolve panels can be increased in height in 6”H, 12”H, 18”H or 24”H increments. See Extension Modules for part numbers.

	DESCRIPTION	PRODUCT CODE	LIST PRICE		DIMENSIONS/INCHES		
			Gr1	Gr2	H	W	D
	Write Board Panel - Double Sided - 54” High	EVPF2W5418	593	613	54	18	2 7/8
		EVPF2W5424	742	763	54	24	2 7/8
		EVPF2W5430	925	953	54	30	2 7/8
		EVPF2W5436	998	1032	54	36	2 7/8
		EVPF2W5442	1134	1172	54	42	2 7/8
		EVPF2W5448	1326	1367	54	48	2 7/8
		EVPF2W5454	1472	1516	54	54	2 7/8
		EVPF2W5460	1622	1675	54	60	2 7/8
	Write Board Panel - Double Sided - 66” High	EVPF2W6618	736	763	66	18	2 7/8
		EVPF2W6624	917	951	66	24	2 7/8
		EVPF2W6630	1122	1164	66	30	2 7/8
		EVPF2W6636	1227	1275	66	36	2 7/8
		EVPF2W6642	1388	1443	66	42	2 7/8
		EVPF2W6648	1598	1656	66	48	2 7/8
		EVPF2W6654	1783	1850	66	54	2 7/8
		EVPF2W6660	1964	2037	66	60	2 7/8

**EVPLF2W - WRITE BOARD LIGHT PANEL - DOUBLE SIDED**

- Write Board Light Panel incorporates fabric modules with a single 24”H top position write board module, into a solid steel frame.
- Use erasable writeboard markers only.
- There is no base raceway in Light Panels to accommodate electrical.
- Light Panel Connectors must be used in conjunction with Light Panels.
- Opposite sides of each panel may have a different fabric within the same grade at no upcharge.
- If different grades of fabric are used on one panel, the entire panel must be priced at highest grade.
- An aluminum low profile top cap is included.
- Stackability: Evolve panels can be increased in height in 6”H, 12”H, 18”H or 24”H increments. See Extension Modules for part numbers.

	DESCRIPTION	PRODUCT CODE	LIST PRICE		DIMENSIONS/INCHES		
			Gr1	Gr2	H	W	D
	Write Board Light Panel - Double Sided - 54” High	EVPLF2W5418	575	592	54	18	2 7/8
		EVPLF2W5424	721	742	54	18	2 7/8
		EVPLF2W5430	894	922	54	18	2 7/8
		EVPLF2W5436	972	1005	54	18	2 7/8
		EVPLF2W5442	1098	1136	54	18	2 7/8
		EVPLF2W5448	1283	1322	54	18	2 7/8
		EVPLF2W5454	1428	1472	54	18	2 7/8
		EVPLF2W5460	1573	1623	54	18	2 7/8
	Write Board Light Panel - Double Sided - 66” High	EVPLF2W6618	715	741	66	18	2 7/8
		EVPLF2W6624	889	923	66	24	2 7/8
		EVPLF2W6630	1087	1129	66	30	2 7/8
		EVPLF2W6636	1191	1238	66	36	2 7/8
		EVPLF2W6642	1349	1402	66	42	2 7/8
		EVPLF2W6648	1550	1608	66	48	2 7/8
		EVPLF2W6654	1730	1796	66	54	2 7/8
		EVPLF2W6660	1975	1975	66	60	2 7/8

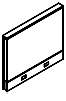
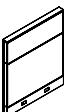
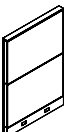
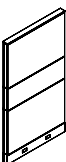

**EVPH1S - LAMINATE PANEL - SINGLE SIDED**

- Laminate Panel incorporates single sided laminate modules, into a solid steel frame.
- Opposite side is fabric covered.
- Laminate faces on all modules provide durable, washable surfaces on Single Sided of the panel.
- Available in high pressure laminate only.
- If wood grain is selected, grain runs horizontally.
- If different grades of fabric are used on one panel, the entire panel must be priced at highest grade.
- An aluminum low profile top cap is included.
- Stackability: Evolve panels can be increased in height in 6”H, 12”H, 18”H or 24”H increments. See Extension Modules for part numbers.

	DESCRIPTION	PRODUCT CODE	LIST PRICE		DIMENSIONS/INCHES		
			Gr1	Gr2	H	W	D
	Laminate Panel - Single Sided - 30” High	EVPH1S3018	452	463	30	18	2 7/8
		EVPH1S3024	540	554	30	24	2 7/8
		EVPH1S3030	629	646	30	30	2 7/8
		EVPH1S3036	715	734	30	36	2 7/8
		EVPH1S3042	815	832	30	42	2 7/8
		EVPH1S3048	885	903	30	48	2 7/8
		EVPH1S3054	974	997	30	54	2 7/8
		EVPH1S3060	1070	1093	30	60	2 7/8
	Laminate Panel - Single Sided - 42” High	EVPH1S4218	538	553	42	18	2 7/8
		EVPH1S4224	639	659	42	24	2 7/8
		EVPH1S4230	748	771	42	30	2 7/8
		EVPH1S4236	856	884	42	36	2 7/8
		EVPH1S4242	972	1001	42	42	2 7/8
		EVPH1S4248	1056	1088	42	48	2 7/8
		EVPH1S4254	1171	1207	42	54	2 7/8
		EVPH1S4260	1283	1322	42	60	2 7/8
	Laminate Panel - Single Sided - 54” High	EVPH1S5418	630	645	54	18	2 7/8
		EVPH1S5424	758	785	54	24	2 7/8
		EVPH1S5430	889	917	54	30	2 7/8
		EVPH1S5436	1018	1050	54	36	2 7/8
		EVPH1S5442	1153	1191	54	42	2 7/8
		EVPH1S5448	1258	1299	54	48	2 7/8
		EVPH1S5454	1399	1443	54	54	2 7/8
		EVPH1S5460	1536	1586	54	60	2 7/8
	Laminate Panel - Single Sided - 66” High	EVPH1S6618	779	802	66	18	2 7/8
		EVPH1S6624	936	968	66	24	2 7/8
		EVPH1S6630	1093	1129	66	30	2 7/8
		EVPH1S6636	1262	1303	66	36	2 7/8
		EVPH1S6642	1434	1478	66	42	2 7/8
		EVPH1S6648	1559	1611	66	48	2 7/8
		EVPH1S6654	1738	1795	66	54	2 7/8
		EVPH1S6660	1912	1973	66	60	2 7/8



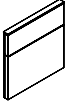
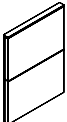

**EVPLH1S - LAMINATE LIGHT PANEL - SINGLE SIDED**

- Laminate Panel incorporates single sided laminate modules, into a solid steel frame.
- Opposite side is fabric covered.
- Laminate faces on all modules provide durable, washable surfaces on Single Sided of the panel.
- Available in high pressure laminate only.
- If wood grain is selected, grain runs horizontally.
- There is no base raceway in Light Panels to accommodate electrical.
- Light Panel Connectors must be used in conjunction with Light Panels.
- If different grades of fabric are used on one panel, the entire panel must be priced at highest grade.
- An aluminum low profile top cap is included.
- Stackability: Evolve panels can be increased in height in 6”H, 12”H, 18”H or 24”H increments. See Extension Modules for part numbers.

	DESCRIPTION	PRODUCT CODE	LIST PRICE		DIMENSIONS/INCHES		
			Gr1	Gr2	H	W	D
	Laminate Light Panel - Single Sided - 30" High	EVPLH1S3018	440	448	30	18	2 7/8
		EVPLH1S3024	526	537	30	24	2 7/8
		EVPLH1S3030	610	619	30	30	2 7/8
		EVPLH1S3036	694	713	30	36	2 7/8
		EVPLH1S3042	787	801	30	42	2 7/8
		EVPLH1S3048	858	872	30	48	2 7/8
		EVPLH1S3054	944	969	30	54	2 7/8
		EVPLH1S3060	1036	1057	30	60	2 7/8
	Laminate Light Panel - Single Sided - 42" High	EVPLH1S4218	523	537	42	18	2 7/8
		EVPLH1S4224	618	638	42	24	2 7/8
		EVPLH1S4230	725	751	42	30	2 7/8
		EVPLH1S4236	830	858	42	36	2 7/8
		EVPLH1S4242	941	970	42	42	2 7/8
		EVPLH1S4248	1027	1056	42	48	2 7/8
		EVPLH1S4254	1137	1171	42	54	2 7/8
		EVPLH1S4260	1245	1283	42	60	2 7/8
	Laminate Light Panel - Single Sided - 54" High	EVPLH1S5418	611	625	54	18	2 7/8
		EVPLH1S5424	735	761	54	24	2 7/8
		EVPLH1S5430	864	891	54	30	2 7/8
		EVPLH1S5436	986	1019	54	36	2 7/8
		EVPLH1S5442	1118	1152	54	42	2 7/8
		EVPLH1S5448	1219	1260	54	48	2 7/8
		EVPLH1S5454	1356	1400	54	54	2 7/8
		EVPLH1S5460	1490	1540	54	60	2 7/8
	Laminate Light Panel - Single Sided - 66" High	EVPLH1S6618	756	782	66	18	2 7/8
		EVPLH1S6624	909	938	66	24	2 7/8
		EVPLH1S6630	1059	1093	66	30	2 7/8
		EVPLH1S6636	1222	1261	66	36	2 7/8
		EVPLH1S6642	1388	1432	66	42	2 7/8
		EVPLH1S6648	1516	1564	66	48	2 7/8
		EVPLH1S6654	1684	1741	66	54	2 7/8
		EVPLH1S6660	1854	1915	66	60	2 7/8



**EVPH2S - LAMINATE PANEL - DOUBLE SIDED**

- Laminate Panel incorporates double sided laminate modules, into a solid steel frame.
- Laminate faces on all modules provide durable, washable surfaces on Single Sided of the panel.
- Available in high pressure laminate only.
- If wood grain is selected, grain runs horizontally.
- If different grades of fabric are used on one panel, the entire panel must be priced at highest grade.
- An aluminum low profile top cap is included.
- Stackability: Evolve panels can be increased in height in 6”H, 12”H, 18”H or 24”H increments. See Extension Modules for part numbers.

	DESCRIPTION	PRODUCT CODE	LIST PRICE	DIMENSIONS/INCHES		
				H	W	D
	Laminate Panel - Double Sided - 30" High	EVPH2S3018	616	30	18	2 7/8
		EVPH2S3024	616	30	24	2 7/8
		EVPH2S3030	726	30	30	2 7/8
		EVPH2S3036	830	30	36	2 7/8
		EVPH2S3042	944	30	42	2 7/8
		EVPH2S3048	1053	30	48	2 7/8
		EVPH2S3054	1169	30	54	2 7/8
	EVPH2S3060	1262	30	60	2 7/8	
	Laminate Panel - Double Sided - 42" High	EVPH2S4218	598	42	18	2 7/8
		EVPH2S4224	726	42	24	2 7/8
		EVPH2S4230	855	42	30	2 7/8
		EVPH2S4236	995	42	36	2 7/8
		EVPH2S4242	1134	42	42	2 7/8
		EVPH2S4248	1268	42	48	2 7/8
		EVPH2S4254	1396	42	54	2 7/8
	EVPH2S4260	1517	42	60	2 7/8	
	Laminate Panel - Double Sided - 54" High	EVPH2S5418	701	54	18	2 7/8
		EVPH2S5424	858	54	24	2 7/8
		EVPH2S5430	1017	54	30	2 7/8
		EVPH2S5436	1181	54	36	2 7/8
		EVPH2S5442	1348	54	42	2 7/8
		EVPH2S5448	1516	54	48	2 7/8
		EVPH2S5454	1670	54	54	2 7/8
	EVPH2S5460	1816	54	60	2 7/8	
	Laminate Panel - Double Sided - 66" High	EVPH2S6618	885	66	18	2 7/8
		EVPH2S6624	1085	66	24	2 7/8
		EVPH2S6630	1283	66	30	2 7/8
		EVPH2S6636	1490	66	36	2 7/8
		EVPH2S6642	1705	66	42	2 7/8
		EVPH2S6648	1912	66	48	2 7/8
		EVPH2S6654	2109	66	54	2 7/8
	EVPH2S6660	2304	66	60	2 7/8	

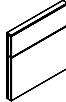

**EVPLH2S - LAMINATE LIGHT PANEL - DOUBLE SIDED**

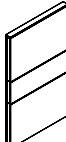
- Laminate Panel incorporates double sided laminate modules, into a solid steel frame.
- Laminate faces on all modules provide durable, washable surfaces on Single Sided of the panel.
- Available in high pressure laminate only
- If wood grain is selected, grain runs horizontally.
- There is no base raceway in Light Panels to accommodate electrical.
- Light Panel Connectors must be used in conjunction with Light Panels.
- If different grades of fabric are used on one panel, the entire panel must be priced at highest grade.
- An aluminum low profile top cap is included.
- Stackability: Evolve panels can be increased in height in 6”H, 12”H, 18”H or 24”H increments. See Extension Modules for part numbers.

	DESCRIPTION	PRODUCT CODE	LIST PRICE	DIMENSIONS/INCHES		
				H	W	D
	Laminate Light Panel - Double Sided - 30" High	EVPLH2S3018	596	30	18	2 7/8
		EVPLH2S3024	596	30	24	2 7/8
		EVPLH2S3030	703	30	30	2 7/8
		EVPLH2S3036	804	30	36	2 7/8
		EVPLH2S3042	919	30	42	2 7/8
		EVPLH2S3048	1024	30	48	2 7/8
		EVPLH2S3054	1135	30	54	2 7/8
		EVPLH2S3060	1222	30	60	2 7/8
	Laminate Light Panel - Double Sided - 42" High	EVPLH2S4218	582	42	18	2 7/8
		EVPLH2S4224	703	42	24	2 7/8
		EVPLH2S4230	829	42	30	2 7/8
		EVPLH2S4236	966	42	36	2 7/8
		EVPLH2S4242	1098	42	42	2 7/8
		EVPLH2S4248	1233	42	48	2 7/8
		EVPLH2S4254	1352	42	54	2 7/8
		EVPLH2S4260	1472	42	60	2 7/8
	Laminate Light Panel - Double Sided - 54" High	EVPLH2S5418	680	54	18	2 7/8
		EVPLH2S5424	831	54	24	2 7/8
		EVPLH2S5430	985	54	30	2 7/8
		EVPLH2S5436	1144	54	36	2 7/8
		EVPLH2S5442	1306	54	42	2 7/8
		EVPLH2S5448	1471	54	48	2 7/8
		EVPLH2S5454	1619	54	54	2 7/8
		EVPLH2S5460	1759	54	60	2 7/8
	Laminate Light Panel - Double Sided - 66" High	EVPLH2S6618	756	66	18	2 7/8
		EVPLH2S6624	1051	66	24	2 7/8
		EVPLH2S6630	1245	66	30	2 7/8
		EVPLH2S6636	1444	66	36	2 7/8
		EVPLH2S6642	1653	66	42	2 7/8
		EVPLH2S6648	1854	66	48	2 7/8
		EVPLH2S6654	2046	66	54	2 7/8
		EVPLH2S6660	2235	66	60	2 7/8

**EVPFAF - AIRFLOW PANEL**

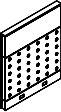
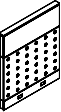
- Airflow Panel incorporates bottom 24”H airflow module with individual fabric modules, within a steel frame.
- The 24”H Metal airflow module is positioned in the base section to provide air circulation.
- Opposite sides of each panel may have a different fabric within the same grade at no upcharge.
- If different grades of fabric are used on one panel, the entire panel must be priced at highest grade.
- An aluminum low profile top cap is included.
- Stackability: Evolve panels can be increased in height in 6”H, 12”H, 18”H or 24”H increments. See Extension Modules for part numbers.

	DESCRIPTION	PRODUCT CODE	LIST PRICE		DIMENSIONS/INCHES		
			Gr1	Gr2	H	W	D
	Airflow Panel - 30” High	EVPFAF3024	517		30	24	2 7/8
		EVPFAF3030	615		30	30	2 7/8
		EVPFAF3036	680		30	36	2 7/8
		EVPFAF3042	756		30	42	2 7/8
		EVPFAF3048	852		30	48	2 7/8
		EVPFAF3054	976		30	54	2 7/8
		EVPFAF3060	1102		30	60	2 7/8
	Airflow Panel - 42” High	EVPFAF4224	659	673	42	24	2 7/8
		EVPFAF4230	779	796	42	30	2 7/8
		EVPFAF4236	867	887	42	36	2 7/8
		EVPFAF4242	963	983	42	42	2 7/8
		EVPFAF4248	1089	1110	42	48	2 7/8
		EVPFAF4254	1240	1266	42	54	2 7/8
		EVPFAF4260	1258	1285	42	60	2 7/8
	Airflow Panel - 54” High	EVPFAF5424	739	765	54	24	2 7/8
		EVPFAF5430	851	879	54	30	2 7/8
		EVPFAF5436	951	984	54	36	2 7/8
		EVPFAF5442	1059	1097	54	42	2 7/8
		EVPFAF5448	1191	1232	54	48	2 7/8
		EVPFAF5454	1386	1434	54	54	2 7/8
		EVPFAF5460	1512	1562	54	60	2 7/8
	Airflow Panel - 66” High	EVPFAF6624	863	897	66	24	2 7/8
		EVPFAF6630	1017	1058	66	30	2 7/8
		EVPFAF6636	1138	1186	66	36	2 7/8
		EVPFAF6642	1268	1321	66	42	2 7/8
		EVPFAF6648	1429	1488	66	48	2 7/8
		EVPFAF6654	1615	1682	66	54	2 7/8
		EVPFAF6660	1797	1870	66	60	2 7/8

**EVPLFAF - AIRFLOW LIGHT PANEL**

- Airflow Light Panel incorporates bottom 24”H airflow module with individual fabric modules, within a steel frame.
- The 24”H Metal airflow module is positioned in the base section to provide air circulation.
- There is no base raceway in Light Panels to accommodate electrical.
- Light Panel Connectors must be used in conjunction with Light Panels.
- Opposite sides of each panel may have a different fabric within the same grade at no upcharge.
- If different grades of fabric are used on one panel, the entire panel must be priced at highest grade.
- An aluminum low profile top cap is included.
- Stackability: Evolve panels can be increased in height in 6”H, 12”H, 18”H or 24”H increments. See Extension Module listings for part numbers

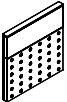
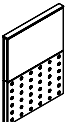
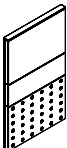
	DESCRIPTION	PRODUCT CODE	LIST PRICE		DIMENSIONS/INCHES		
			Gr1	Gr2	H	W	D
	Airflow Light Panel - 30” High	EVPLFAF3024	503		30	18	2 7/8
		EVPLFAF3030	595		30	30	2 7/8
		EVPLFAF3036	660		30	36	2 7/8
		EVPLFAF3042	732		30	42	2 7/8
		EVPLFAF3048	824		30	48	2 7/8
		EVPLFAF3054	949		30	54	2 7/8
		EVPLFAF3060	1072		30	60	2 7/8
	Airflow Light Panel - 42” High	EVPLFAF4224	640	651	42	18	2 7/8
		EVPLFAF4230	756	774	42	30	2 7/8
		EVPLFAF4236	840	860	42	36	2 7/8
		EVPLFAF4242	932	953	42	42	2 7/8
		EVPLFAF4248	1053	1074	42	48	2 7/8
		EVPLFAF4254	1200	1226	42	54	2 7/8
		EVPLFAF4260	1219	1247	42	60	2 7/8
	Airflow Light Panel - 54” High	EVPLFAF5424	718	741	54	18	2 7/8
		EVPLFAF5430	823	852	54	30	2 7/8
		EVPLFAF5436	925	958	54	36	2 7/8
		EVPLFAF5442	1029	1067	54	42	2 7/8
		EVPLFAF5448	1154	1195	54	48	2 7/8
		EVPLFAF5454	1345	1386	54	54	2 7/8
		EVPLFAF5460	1467	1515	54	60	2 7/8
	Airflow Light Panel - 66” High	EVPLFAF6624	834	867	66	18	2 7/8
		EVPLFAF6630	985	1026	66	30	2 7/8
		EVPLFAF6636	1105	1152	66	36	2 7/8
		EVPLFAF6642	1233	1285	66	42	2 7/8
		EVPLFAF6648	1385	1443	66	48	2 7/8
		EVPLFAF6654	1568	1629	66	54	2 7/8
		EVPLFAF6660	1745	1815	30	60	2 7/8

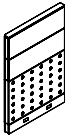
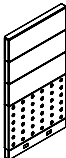

**EVPPPAF - AIRFLOW PREMIUM PANEL**

- Airflow Premium Panel incorporates bottom 24”H airflow module with individual fabric modules, within a steel frame.
- The 24”H Metal airflow module is positioned in the base section to provide air circulation.
- Premium panels incorporate 12”H acoustic modules above 30”H base section.
- Opposite sides of each panel may have a different fabric within the same grade at no upcharge.
- If different grades of fabric are used on one panel, the entire panel must be priced at highest grade.
- An aluminum low profile top cap is included.
- Stackability: Evolve panels can be increased in height in 6”H, 12”H, 18”H or 24”H increments. See Extension Modules for part numbers.

	DESCRIPTION	PRODUCT CODE	LIST PRICE		DIMENSIONS/INCHES		
			Gr1	Gr2	H	W	D
	Airflow Premium Panel - 54” High	EVPPPAF5424	821	844	54	24	2 7/8
		EVPPPAF5430	940	969	54	30	2 7/8
		EVPPPAF5436	1051	1083	54	36	2 7/8
		EVPPPAF5442	1168	1206	54	42	2 7/8
		EVPPPAF5448	1322	1364	54	48	2 7/8
		EVPPPAF5454	1494	1541	54	54	2 7/8
	Airflow Premium Panel - 66” High	EVPPPAF6624	941	975	66	24	2 7/8
		EVPPPAF6630	1105	1146	66	30	2 7/8
		EVPPPAF6636	1236	1284	66	36	2 7/8
		EVPPPAF6642	1372	1425	66	42	2 7/8
		EVPPPAF6648	1558	1619	66	48	2 7/8
		EVPPPAF6654	1754	1821	66	54	2 7/8
EVPPPAF6660	1958	2029	66	60	2 7/8		



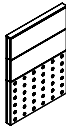

**EVPLPPAF - AIRFLOW PREMIUM LIGHT PANEL**

- Airflow Premium Light Panel incorporates bottom 24”H airflow module with individual 12”H fabric modules, within a steel frame.
- The 24”H Metal airflow module is positioned in the base section to provide air circulation.
- Premium panels incorporate 12”H acoustic modules above 30”H base section.
- There is no base raceway in Light Panels to accommodate electrical.
- Light Panel Connectors must be used in conjunction with Light Panels.
- Opposite sides of each panel may have a different fabric within the same grade at no upcharge.
- If different grades of fabric are used on one panel, the entire panel must be priced at highest grade.
- An aluminum low profile top cap is included.
- Stackability: Evolve panels can be increased in height in 6”H, 12”H, 18”H or 24”H increments. See Extension Modules for part numbers.

	DESCRIPTION	PRODUCT CODE	LIST PRICE		DIMENSIONS/INCHES		
			Gr1	Gr2	H	W	D
	Airflow Premium Light Panel - 54” High	EVPLPPAF5424	797	820	54	18	2 7/8
		EVPLPPAF5430	914	941	54	30	2 7/8
		EVPLPPAF5436	1021	1050	54	36	2 7/8
		EVPLPPAF5442	1134	1170	54	42	2 7/8
		EVPLPPAF5448	1280	1319	54	48	2 7/8
		EVPLPPAF5454	1451	1492	54	54	2 7/8
	Airflow Premium Light Panel - 66” High	EVPLPPAF6624	915	947	66	18	2 7/8
		EVPLPPAF6630	1074	1113	66	30	2 7/8
		EVPLPPAF6636	1199	1247	66	36	2 7/8
		EVPLPPAF6642	1331	1383	66	42	2 7/8
		EVPLPPAF6648	1513	1572	66	48	2 7/8
		EVPLPPAF6654	1703	1764	66	54	2 7/8
EVPLPPAF6660	1898	1968	66	60	2 7/8		

**EVPM1S - METAL SKIN PANEL - SINGLE SIDED**

- Metal Skin Panel incorporates single sided metal skin modules, into a solid steel frame.
- Opposite side is fabric covered.
- Metal faces on all modules provide durable, washable and magnetic surfaces on Single Sided of the panel.
- If different grades of fabric are used on one panel, the entire panel must be priced at highest grade.
- An aluminum low profile top cap is included.
- Stackability: Evolve panels can be increased in height in 6”H, 12”H, 18”H or 24”H increments. See Extension Modules for part numbers.

	DESCRIPTION	PRODUCT CODE	LIST PRICE		DIMENSIONS/INCHES		
			Gr1	Gr2	H	W	D
	Metal Skin Panel - Single Sided 30" High	EVPM1S3018	586	597	30	18	2 7/8
		EVPM1S3024	701	716	30	24	2 7/8
		EVPM1S3030	817	831	30	30	2 7/8
		EVPM1S3036	928	946	30	36	2 7/8
		EVPM1S3042	1052	1073	30	42	2 7/8
		EVPM1S3048	1146	1167	30	48	2 7/8
		EVPM1S3054	1266	1287	30	54	2 7/8
		EVPM1S3060	1386	1412	30	60	2 7/8
	Metal Skin Panel - Single Sided 42" High	EVPM1S4218	695	710	42	18	2 7/8
		EVPM1S4224	828	846	42	24	2 7/8
		EVPM1S4230	972	995	42	30	2 7/8
		EVPM1S4236	1111	1139	42	36	2 7/8
		EVPM1S4242	1262	1290	42	42	2 7/8
		EVPM1S4248	1371	1404	42	48	2 7/8
		EVPM1S4254	1523	1557	42	54	2 7/8
		EVPM1S4260	1671	1710	42	60	2 7/8
	Metal Skin Panel - Single Sided 54" High	EVPM1S5418	819	837	54	18	2 7/8
		EVPM1S5424	985	1008	54	24	2 7/8
		EVPM1S5430	1153	1180	54	30	2 7/8
		EVPM1S5436	1318	1352	54	36	2 7/8
		EVPM1S5442	1495	1533	54	42	2 7/8
		EVPM1S5448	1633	1674	54	48	2 7/8
		EVPM1S5454	1816	1863	54	54	2 7/8
		EVPM1S5460	1996	2046	54	60	2 7/8
	Metal Skin Panel - Single Sided 66" High	EVPM1S6618	1008	1034	66	18	2 7/8
		EVPM1S6624	1216	1245	66	24	2 7/8
		EVPM1S6630	1420	1456	66	30	2 7/8
		EVPM1S6636	1639	1680	66	36	2 7/8
		EVPM1S6642	1862	1906	66	42	2 7/8
		EVPM1S6648	2027	2079	66	48	2 7/8
		EVPM1S6654	2254	2311	66	54	2 7/8
		EVPM1S6660	2483	2546	66	60	2 7/8



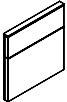
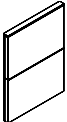
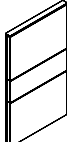

**EVPLM1S - METAL SKIN LIGHT PANEL - SINGLE SIDED**

- Metal Skin Light Panel incorporates single sided metal skin modules, into a solid steel frame.
- Opposite side is fabric covered.
- Metal faces on all modules provide durable, washable and magnetic surfaces on Single Sided of the panel.
- There is no base raceway in Light Panels to accommodate electrical.
- Light Panel Connectors must be used in conjunction with Light Panels.
- If different grades of fabric are used on one panel, the entire panel must be priced at highest grade.
- An aluminum low profile top cap is included.
- Stackability: Evolve panels can be increased in height in 6”H, 12”H, 18”H or 24”H increments. See Extension Modules for part numbers.

	DESCRIPTION	PRODUCT CODE	LIST PRICE		DIMENSIONS/INCHES		
			Gr1	Gr2	H	W	D
	Metal Skin Light Panel - Single Sided - 30” High	EVPLM1S3018	571	580	30	18	2 7/8
		EVPLM1S3024	680	692	30	24	2 7/8
		EVPLM1S3030	788	800	30	30	2 7/8
		EVPLM1S3036	899	918	30	36	2 7/8
		EVPLM1S3042	1023	1038	30	42	2 7/8
		EVPLM1S3048	1111	1130	30	48	2 7/8
		EVPLM1S3054	1231	1246	30	54	2 7/8
		EVPLM1S3060	1345	1368	30	60	2 7/8
	Metal Skin Light Panel - Single Sided - 42” High	EVPLM1S4218	677	691	42	18	2 7/8
		EVPLM1S4224	801	819	42	24	2 7/8
		EVPLM1S4230	941	964	42	30	2 7/8
		EVPLM1S4236	1079	1106	42	36	2 7/8
		EVPLM1S4242	1222	1250	42	42	2 7/8
		EVPLM1S4248	1329	1362	42	48	2 7/8
		EVPLM1S4254	1475	1509	42	54	2 7/8
		EVPLM1S4260	1620	1658	42	60	2 7/8
	Metal Skin Light Panel - Single Sided - 54” High	EVPLM1S5418	791	809	54	18	2 7/8
		EVPLM1S5424	953	974	54	24	2 7/8
		EVPLM1S5430	1118	1144	54	30	2 7/8
		EVPLM1S5436	1278	1311	54	36	2 7/8
		EVPLM1S5442	1452	1488	54	42	2 7/8
		EVPLM1S5448	1585	1624	54	48	2 7/8
		EVPLM1S5454	1759	1807	54	54	2 7/8
		EVPLM1S5460	1935	1985	54	60	2 7/8
	Metal Skin Light Panel - Single Sided - 66” High	EVPLM1S6618	981	1007	66	18	2 7/8
		EVPLM1S6624	1181	1209	66	24	2 7/8
		EVPLM1S6630	1377	1413	66	30	2 7/8
		EVPLM1S6636	1588	1629	66	36	2 7/8
		EVPLM1S6642	1807	1851	66	42	2 7/8
		EVPLM1S6648	1964	2016	66	48	2 7/8
		EVPLM1S6654	2188	2243	66	54	2 7/8
		EVPLM1S6660	2408	2469	66	60	2 7/8



**EVPM2S - METAL SKIN PANEL - DOUBLE SIDED**

- Metal Skin Panel incorporates double sided metal skin modules, into a solid steel frame.
- Metal faces on all modules provide durable, washable and magnetic surfaces on Single Sided of the panel.
- If different grades of fabric are used on one panel, the entire panel must be priced at highest grade.
- An aluminum low profile top cap is included.
- Stackability: Evolve panels can be increased in height in 6”H, 12”H, 18”H or 24”H increments. See Extension Modules for part numbers.

	DESCRIPTION	PRODUCT CODE	LIST PRICE	DIMENSIONS/INCHES		
				H	W	D
	Metal Skin Panel - Double Sided - 30” High	EVPM2S3018	863	30	18	2 7/8
		EVPM2S3024	863	30	24	2 7/8
		EVPM2S3030	1015	30	30	2 7/8
		EVPM2S3036	1161	30	36	2 7/8
		EVPM2S3042	1161	30	42	2 7/8
		EVPM2S3048	1318	30	48	2 7/8
		EVPM2S3054	1474	30	54	2 7/8
		EVPM2S3060	1761	30	60	2 7/8
	Metal Skin Panel - Double Sided - 42” High	EVPM2S4218	834	42	18	2 7/8
		EVPM2S4224	1015	42	24	2 7/8
		EVPM2S4230	1195	42	30	2 7/8
		EVPM2S4236	1388	42	36	2 7/8
		EVPM2S4242	1583	42	42	2 7/8
		EVPM2S4248	1776	42	48	2 7/8
		EVPM2S4254	1950	42	54	2 7/8
		EVPM2S4260	2122	42	60	2 7/8
	Metal Skin Panel - Double Sided - 54” High	EVPM2S5418	981	54	18	2 7/8
		EVPM2S5424	1199	54	24	2 7/8
		EVPM2S5430	1419	54	30	2 7/8
		EVPM2S5436	1648	54	36	2 7/8
		EVPM2S5442	1886	54	42	2 7/8
		EVPM2S5448	2119	54	48	2 7/8
		EVPM2S5454	2331	54	54	2 7/8
		EVPM2S5460	2542	54	60	2 7/8
	Metal Skin Panel - Double Sided - 66” High	EVPM2S6618	1234	66	18	2 7/8
		EVPM2S6624	1517	66	24	2 7/8
		EVPM2S6630	1796	66	30	2 7/8
		EVPM2S6636	2086	66	36	2 7/8
		EVPM2S6642	2383	66	42	2 7/8
		EVPM2S6648	2674	66	48	2 7/8
		EVPM2S6654	2949	66	54	2 7/8
		EVPM2S6660	3228	66	60	2 7/8

**EVPLM2S - METAL SKIN LIGHT PANEL - DOUBLE SIDED**

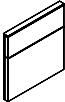
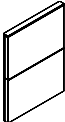
- Metal Skin Light Panel incorporates double sided metal skin modules, into a solid steel frame.
- Metal faces on all modules provide durable, washable and magnetic surfaces on Single Sided of the panel.
- There is no base raceway in Light Panels to accommodate electrical.
- Light Panel Connectors must be used in conjunction with Light Panels.
- If different grades of fabric are used on one panel, the entire panel must be priced at highest grade.
- An aluminum low profile top cap is included.
- Stackability: Evolve panels can be increased in height in 6”H, 12”H, 18”H or 24”H increments. See Extension Modules for part numbers.

	DESCRIPTION	PRODUCT CODE	LIST PRICE	DIMENSIONS/INCHES		
				H	W	D
	Metal Skin Light Panel - Double Sided - 30" High	EVPLM2S3018	834	30	18	2 7/8
		EVPLM2S3024	834	30	24	2 7/8
		EVPLM2S3030	984	30	30	2 7/8
		EVPLM2S3036	1127	30	36	2 7/8
		EVPLM2S3042	1127	30	42	2 7/8
		EVPLM2S3048	1278	30	48	2 7/8
		EVPLM2S3054	1429	30	54	2 7/8
		EVPLM2S3060	1710	30	60	2 7/8
	Metal Skin Light Panel - Double Sided - 42" High	EVPLM2S4218	810	42	18	2 7/8
		EVPLM2S4224	984	42	24	2 7/8
		EVPLM2S4230	1157	42	30	2 7/8
		EVPLM2S4236	1349	42	36	2 7/8
		EVPLM2S4242	1534	42	42	2 7/8
		EVPLM2S4248	1721	42	48	2 7/8
		EVPLM2S4254	1892	42	54	2 7/8
		EVPLM2S4260	2058	42	60	2 7/8
	Metal Skin Light Panel - Double Sided - 54" High	EVPLM2S5418	950	54	18	2 7/8
		EVPLM2S5424	1164	54	24	2 7/8
		EVPLM2S5430	1375	54	30	2 7/8
		EVPLM2S5436	1599	54	36	2 7/8
		EVPLM2S5442	1829	54	42	2 7/8
		EVPLM2S5448	2055	54	48	2 7/8
		EVPLM2S5454	2259	54	54	2 7/8
		EVPLM2S5460	2466	54	60	2 7/8
	Metal Skin Light Panel - Double Sided - 66" High	EVPLM2S6618	1197	66	18	2 7/8
		EVPLM2S6624	1472	66	24	2 7/8
		EVPLM2S6630	1742	66	30	2 7/8
		EVPLM2S6636	2024	66	36	2 7/8
		EVPLM2S6642	2310	66	42	2 7/8
		EVPLM2S6648	2595	66	48	2 7/8
		EVPLM2S6654	2858	66	54	2 7/8
		EVPLM2S6660	3160	66	60	2 7/8

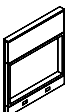
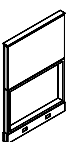
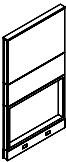

**EVPFOL - OPEN BOTTOM PANEL**

- Open Bottom Panel incorporates bottom 24”H open module with individual fabric modules, within a steel frame.
- The 24”H open bottom module in the base section is to provide air circulation and access to electrical or data.
- Opposite sides of each panel may have a different fabric within the same grade at no upcharge.
- If different grades of fabric are used on one panel, the entire panel must be priced at highest grade.
- An aluminum low profile top cap is included.
- Stackability: Evolve panels can be increased in height in 6”H, 12”H, 18”H or 24”H increments. See Extension Modules for part numbers.

	DESCRIPTION	PRODUCT CODE	LIST PRICE		DIMENSIONS/INCHES		
			Gr1	Gr2	H	W	D
	Open Bottom Panel - 30" High	EVPFOL3018	299		30	18	2 7/8
		EVPFOL3024	340		30	24	2 7/8
		EVPFOL3030	384		30	30	2 7/8
		EVPFOL3036	421		30	36	2 7/8
		EVPFOL3042	462		30	42	2 7/8
		EVPFOL3048	498		30	48	2 7/8
		EVPFOL3054	539		30	54	2 7/8
EVPFOL3060	577		30	60	2 7/8		
	Open Bottom Panel - 42" High	EVPFOL4218	445	455	42	18	2 7/8
		EVPFOL4224	511	525	42	24	2 7/8
		EVPFOL4230	577	594	42	30	2 7/8
		EVPFOL4236	647	667	42	36	2 7/8
		EVPFOL4242	718	739	42	42	2 7/8
		EVPFOL4248	772	793	42	48	2 7/8
		EVPFOL4254	851	872	42	54	2 7/8
EVPFOL4260	923	949	42	60	2 7/8		
	Open Bottom Panel - 54" High	EVPFOL5418	502	522	54	18	2 7/8
		EVPFOL5424	572	598	54	24	2 7/8
		EVPFOL5430	655	682	54	30	2 7/8
		EVPFOL5436	733	767	54	36	2 7/8
		EVPFOL5442	818	856	54	42	2 7/8
		EVPFOL5448	885	926	54	48	2 7/8
		EVPFOL5454	969	1013	54	54	2 7/8
EVPFOL5460	1047	1100	54	60	2 7/8		
	Open Bottom Panel - 66" High	EVPFOL6618	651	679	66	18	2 7/8
		EVPFOL6624	748	784	66	24	2 7/8
		EVPFOL6630	855	896	66	30	2 7/8
		EVPFOL6636	960	1007	66	36	2 7/8
		EVPFOL6642	1078	1135	66	42	2 7/8
		EVPFOL6648	1154	1213	66	48	2 7/8
		EVPFOL6654	1275	1341	66	54	2 7/8
EVPFOL6660	1388	1462	66	60	2 7/8		

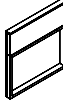
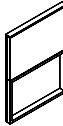

**EVPLFOL - OPEN BOTTOM LIGHT PANEL**

- Open Bottom Light Panel incorporates bottom 24"H open module with individual fabric modules, within a steel frame.
- The 24"H open bottom module in the base section is to provide air circulation and access to electrical or data.
- There is no base raceway in Light Panels to accommodate electrical.
- Light Panel Connectors must be used in conjunction with Light Panels.
- Opposite sides of each panel may have a different fabric within the same grade at no upcharge.
- If different grades of fabric are used on one panel, the entire panel must be priced at highest grade.
- An aluminum low profile top cap is included.
- Stackability: Evolve panels can be increased in height in 6"H, 12"H, 18"H or 24"H increments. See Extension Modules for part numbers.

	DESCRIPTION	PRODUCT CODE	LIST PRICE		DIMENSIONS/INCHES		
			Gr1	Gr2	H	W	D
	Open Bottom Light Panel - 30" High	EVPLFOL3018	288		30	18	2 7/8
		EVPLFOL3024	326		30	24	2 7/8
		EVPLFOL3030	373		30	30	2 7/8
		EVPLFOL3036	409		30	36	2 7/8
		EVPLFOL3042	448		30	42	2 7/8
		EVPLFOL3048	477		30	48	2 7/8
		EVPLFOL3054	525		30	54	2 7/8
		EVPLFOL3060	560		30	60	2 7/8
	Open Bottom Light Panel - 42" High	EVPLFOL4218	430	441	42	18	2 7/8
		EVPLFOL4224	495	510	42	24	2 7/8
		EVPLFOL4230	560	578	42	30	2 7/8
		EVPLFOL4236	629	649	42	36	2 7/8
		EVPLFOL4242	695	716	42	42	2 7/8
		EVPLFOL4248	753	771	42	48	2 7/8
		EVPLFOL4254	823	844	42	54	2 7/8
		EVPLFOL4260	893	920	42	60	2 7/8
	Open Bottom Light Panel - 54" High	EVPLFOL5418	482	502	54	18	2 7/8
		EVPLFOL5424	548	574	54	24	2 7/8
		EVPLFOL5430	630	656	54	30	2 7/8
		EVPLFOL5436	703	736	54	36	2 7/8
		EVPLFOL5442	784	820	54	42	2 7/8
		EVPLFOL5448	850	891	54	48	2 7/8
		EVPLFOL5454	929	971	54	54	2 7/8
		EVPLFOL5460	1006	1058	54	60	2 7/8
	Open Bottom Premium Panel - 66" High	EVPLFOL6618	624	651	60	18	2 7/8
		EVPLFOL6624	721	755	60	24	2 7/8
		EVPLFOL6630	821	860	60	30	2 7/8
		EVPLFOL6636	923	967	60	36	2 7/8
		EVPLFOL6642	1035	1090	60	42	2 7/8
		EVPLFOL6648	1107	1166	60	48	2 7/8
		EVPLFOL6654	1222	1285	60	54	2 7/8
		EVPLFOL6660	1336	1406	60	60	2 7/8

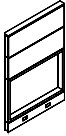

**EVFPOL - OPEN BOTTOM PREMIUM PANEL**

- Open Bottom Premium Panel incorporates bottom 24”H open module with individual fabric modules, within a steel frame.
- The 24”H open bottom module in the base section is to provide air circulation and access to electrical or data.
- Premium panels incorporate 12”H fabric modules above 30”H base section.
- Opposite sides of each panel may have a different fabric within the same grade at no upcharge.
- If different grades of fabric are used on one panel, the entire panel must be priced at highest grade.
- An aluminum low profile top cap is included.
- Stackability: Evolve panels can be increased in height in 6”H, 12”H, 18”H or 24”H increments. See Extension Modules for part numbers.

	DESCRIPTION	PRODUCT CODE	LIST PRICE		DIMENSIONS/INCHES		
			Gr1	Gr2	H	W	D
	Open Bottom Premium Panel - 54” High	EVFPOL5418	593	613	54	18	2 7/8
		EVFPOL5424	679	705	54	24	2 7/8
		EVFPOL5430	776	803	54	30	2 7/8
		EVFPOL5436	870	903	54	36	2 7/8
		EVFPOL5442	981	1017	54	42	2 7/8
		EVFPOL5448	1051	1092	54	48	2 7/8
		EVFPOL5454	1156	1203	54	54	2 7/8
		EVFPOL5460	1267	1315	54	60	2 7/8
	Open Bottom Premium Panel - 66” High	EVFPOL6618	742	770	66	18	2 7/8
		EVFPOL6624	856	892	66	24	2 7/8
		EVFPOL6630	973	1014	66	30	2 7/8
		EVFPOL6636	1098	1146	66	36	2 7/8
		EVFPOL6642	1240	1293	66	42	2 7/8
		EVFPOL6648	1327	1388	66	48	2 7/8
		EVFPOL6654	1471	1538	66	54	2 7/8
		EVFPOL6660	1612	1685	66	60	2 7/8

**EVPLPOL - OPEN BOTTOM PREMIUM LIGHT PANEL**

- Open Bottom Premium Light Panel incorporates bottom 24”H open module with individual fabric modules, within a steel frame.
- The 24”H open bottom module in the base section is to provide air circulation and access to electrical or data.
- Premium panels incorporate 12”H fabric modules above 30”H base section.
- There is no base raceway in Light Panels to accommodate electrical.
- Light Panel Connectors must be used in conjunction with Light Panels.
- Opposite sides of each panel may have a different fabric within the same grade at no upcharge.
- If different grades of fabric are used on one panel, the entire panel must be priced at highest grade.
- An aluminum low profile top cap is included.
- Stackability: Evolve panels can be increased in height in 6”H, 12”H, 18”H or 24”H increments. See Extension Modules for part numbers.

	DESCRIPTION	PRODUCT CODE	LIST PRICE		DIMENSIONS/INCHES		
			Gr1	Gr2	H	W	D
	Open Bottom Premium Light Panel - 54” High	EVPLPOL5418	569	589	54	18	2 7/8
		EVPLPOL5424	651	678	54	24	2 7/8
		EVPLPOL5430	745	771	54	30	2 7/8
		EVPLPOL5436	835	867	54	36	2 7/8
		EVPLPOL5442	940	974	54	42	2 7/8
		EVPLPOL5448	1008	1047	54	48	2 7/8
		EVPLPOL5454	1110	1154	54	54	2 7/8
		EVPLPOL5460	1218	1265	54	60	2 7/8
	Open Bottom Premium Light Panel - 66” High	EVPLPOL6618	713	740	60	18	2 7/8
		EVPLPOL6624	822	856	60	24	2 7/8
		EVPLPOL6630	932	973	60	30	2 7/8
		EVPLPOL6636	1052	1099	60	36	2 7/8
		EVPLPOL6642	1189	1241	60	42	2 7/8
		EVPLPOL6648	1274	1335	60	48	2 7/8
		EVPLPOL6654	1410	1474	60	54	2 7/8
		EVPLPOL6660	1548	1619	60	60	2 7/8

**EVVFO - OPEN MIDDLE PANEL - 12”H OPENING**

- Open Middle Panel incorporates a 12”H middle position open module with fabric modules, within a steel frame.
- Open Middle Panel Incorporates a 12”H opening above 30”H base module to provide pass-through convenience.
- Opposite sides of each panel may have a different fabric within the same grade at no upcharge.
- If different grades of fabric are used on one panel, the entire panel must be priced at highest grade.
- An aluminum low profile top cap is included.
- Stackability: Evolve panels can be increased in height in 6”H, 12”H, 18”H or 24”H increments. See Extension Modules or part numbers.

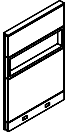
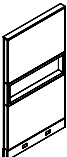
	DESCRIPTION	PRODUCT CODE	LIST PRICE		DIMENSIONS/INCHES		
			Gr1	Gr2	H	W	D
	Open Middle Panel - 12”H Opening - 54” High	EVVFO5418	600	629	54	18	2 7/8
		EVVFO5424	698	734	54	24	2 7/8
		EVVFO5430	803	844	54	30	2 7/8
		EVVFO5436	914	962	54	36	2 7/8
		EVVFO5442	1029	1082	54	42	2 7/8
		EVVFO5448	1110	1171	54	48	2 7/8
		EVVFO5454	1231	1297	54	54	2 7/8
	Open Middle Panel - 12”H Opening - 66” High	EVVFO6618	662	698	66	18	2 7/8
		EVVFO6624	764	812	66	24	2 7/8
		EVVFO6630	880	932	66	30	2 7/8
		EVVFO6636	998	1061	66	36	2 7/8
		EVVFO6642	1126	1195	66	42	2 7/8
		EVVFO6648	1215	1295	66	48	2 7/8
		EVVFO6654	1348	1436	66	54	2 7/8
	EVVFO6660	1472	1570	66	60	2 7/8	

**EVPLFO - OPEN MIDDLE LIGHT PANEL - 12”H OPENING**

- Open Middle Light Panel incorporates a 12”H middle position open module with fabric modules, within a steel frame.
- Open Middle Light Panel Incorporates a 12”H opening above 30”H base module to provide pass-through convenience.
- There is no base raceway in Light Panels to accommodate electrical.
- Light Panel Connectors must be used in conjunction with Light Panels.
- Opposite sides of each panel may have a different fabric within the same grade at no upcharge.
- If different grades of fabric are used on one panel, the entire panel must be priced at highest grade.
- An aluminum low profile top cap is included.
- Stackability: Evolve panels can be increased in height in 6”H, 12”H, 18”H or 24”H increments. See Extension Modules for part numbers.

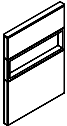
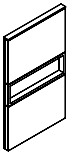
	DESCRIPTION	PRODUCT CODE	LIST PRICE		DIMENSIONS/INCHES		
			Gr1	Gr2	H	W	D
	Open Middle Light Panel - 12”H Opening - 54” High	EVPLFO5418	572	599	54	18	2 7/8
		EVPLFO5424	665	699	54	24	2 7/8
		EVPLFO5430	764	803	54	30	2 7/8
		EVPLFO5436	867	911	54	36	2 7/8
		EVPLFO5442	976	1029	54	42	2 7/8
		EVPLFO5448	1053	1110	54	48	2 7/8
		EVPLFO5454	1168	1232	54	54	2 7/8
	Open Middle Light Panel - 12”H Opening - 66” High	EVPLFO6618	630	664	60	18	2 7/8
		EVPLFO6624	726	768	60	24	2 7/8
		EVPLFO6630	834	886	60	30	2 7/8
		EVPLFO6636	950	1008	60	36	2 7/8
		EVPLFO6642	1070	1136	60	42	2 7/8
		EVPLFO6648	1154	1228	60	48	2 7/8
		EVPLFO6654	1279	1360	60	54	2 7/8
	EVPLFO6660	1399	1492	60	60	2 7/8	

**EVFPFO - OPEN MIDDLE PREMIUM PANEL - 12”H OPENING**

- Open Middle Premium Panel incorporates a 12”H middle position open module with fabric modules, within a steel frame.
- Open Middle Premium Panel Incorporates a 12”H opening above 30”H base module to provide pass-through convenience.
- Premium panels incorporate 12”H modules above 30”H base section.
- Opposite sides of each panel may have a different fabric within the same grade at no upcharge.
- If different grades of fabric are used on one panel, the entire panel must be priced at highest grade.
- An aluminum low profile top cap is included.
- Stackability: Evolve panels can be increased in height in 6”H, 12”H, 18”H or 24”H increments. See Extension Modules for part numbers.

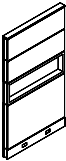
	DESCRIPTION	PRODUCT CODE	LIST PRICE		DIMENSIONS/INCHES		
			Gr1	Gr2	H	W	D
	Open Middle Premium Panel - 12”H Opening - 66” High	EVFPFO6618	753	789	66	18	2 7/8
		EVFPFO6624	870	917	66	24	2 7/8
		EVFPFO6630	1001	1056	66	30	2 7/8
		EVFPFO6636	1134	1195	66	36	2 7/8
		EVFPFO6642	1289	1359	66	42	2 7/8
		EVFPFO6648	1385	1465	66	48	2 7/8
		EVFPFO6654	1536	1623	66	54	2 7/8
		EVFPFO6660	1691	1789	66	60	2 7/8

**EVPLFPO - OPEN MIDDLE PREMIUM LIGHT PANEL - 12” OPENING**

- Open Middle Premium Light Panel incorporates a 12”H middle position open module with fabric modules, within a steel frame.
- Open Middle Premium Light Panel Incorporates a 12”H opening above 30”H base module to provide pass-through convenience.
- Premium panels incorporate 12”H modules above 30”H base section.
- There is no base raceway in Light Panels to accommodate electrical.
- Light Panel Connectors must be used in conjunction with Light Panels.
- Opposite sides of each panel may have a different fabric within the same grade at no upcharge.
- If different grades of fabric are used on one panel, the entire panel must be priced at highest grade.
- An aluminum low profile top cap is included.
- Stackability: Evolve panels can be increased in height in 6”H, 12”H, 18”H or 24”H increments. See Extension Modules for part numbers.

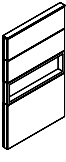
	DESCRIPTION	PRODUCT CODE	LIST PRICE		DIMENSIONS/INCHES		
			Gr1	Gr2	H	W	D
	Open Middle Premium Light Panel - 12”H Opening - 66” High	EVPLFPO6618	714	748	66	18	2 7/8
		EVPLFPO6624	829	871	66	24	2 7/8
		EVPLFPO6630	951	1001	66	30	2 7/8
		EVPLFPO6636	1077	1135	66	36	2 7/8
		EVPLFPO6642	1225	1291	66	42	2 7/8
		EVPLFPO6648	1317	1391	66	48	2 7/8
		EVPLFPO6654	1459	1541	66	54	2 7/8
		EVPLFPO6660	1607	1700	66	60	2 7/8

**EVFOX - OPEN MIDDLE PANEL - 24”H OPENING**

- Open Middle Panel incorporates a 24”H middle position open module with fabric modules, within a steel frame.
- Open Middle Panel Incorporates a 24”H opening above 30”H base module to provide pass-through convenience.
- Opposite sides of each panel may have a different fabric within the same grade at no upcharge.
- If different grades of fabric are used on one panel, the entire panel must be priced at highest grade.
- An aluminum low profile top cap is included.
- Stackability: Evolve panels can be increased in height in 6”H, 12”H, 18”H or 24”H increments. See Extension Modules for part numbers.

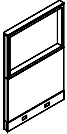
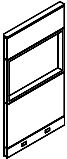
	DESCRIPTION	PRODUCT CODE	LIST PRICE		DIMENSIONS/INCHES		
			Gr1	Gr2	H	W	D
	Open Middle Panel - 24”H Opening - 54” High	EVFOX5418	502	522	54	18	2 7/8
		EVFOX5424	572	598	54	24	2 7/8
		EVFOX5430	655	682	54	30	2 7/8
		EVFOX5436	733	767	54	36	2 7/8
		EVFOX5442	817	855	54	42	2 7/8
		EVFOX5448	880	921	54	48	2 7/8
		EVFOX5454	966	1010	54	54	2 7/8
	Open Middle Panel - 24”H Opening - 66” High	EVFOX6618	651	679	66	18	2 7/8
		EVFOX6624	748	784	66	24	2 7/8
		EVFOX6630	880	921	66	30	2 7/8
		EVFOX6636	960	1007	66	36	2 7/8
		EVFOX6642	1078	1135	66	42	2 7/8
		EVFOX6648	1154	1213	66	48	2 7/8
		EVFOX6654	1275	1341	66	54	2 7/8
		EVFOX6660	1388	1462	66	60	2 7/8

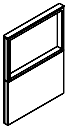
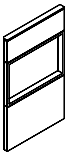

**EVPLFOX - OPEN MIDDLE LIGHT PANEL - 24”H OPENING**

- Open Middle Panel incorporates a 24”H middle position open module with fabric modules, within a steel frame.
- Open Middle Panel Incorporates a 24”H opening above 30”H base module to provide pass-through convenience.
- There is no base raceway in Light Panels to accommodate electrical.
- Light Panel Connectors must be used in conjunction with Light Panels.
- Opposite sides of each panel may have a different fabric within the same grade at no upcharge.
- If different grades of fabric are used on one panel, the entire panel must be priced at highest grade.
- An aluminum low profile top cap is included.
- Stackability: Evolve panels can be increased in height in 6”H, 12”H, 18”H or 24”H increments. See Extension Modules for part numbers.

	DESCRIPTION	PRODUCT CODE	LIST PRICE		DIMENSIONS/INCHES		
			Gr1	Gr2	H	W	D
	Open Middle Light Panel - 24”H Opening - 54” High	EVPLFOX5418	477	495	54	18	2 7/8
		EVPLFOX5424	541	567	54	24	2 7/8
		EVPLFOX5430	622	648	54	30	2 7/8
		EVPLFOX5436	698	731	54	36	2 7/8
		EVPLFOX5442	770	806	54	42	2 7/8
		EVPLFOX5448	834	873	54	48	2 7/8
		EVPLFOX5454	919	961	54	54	2 7/8
	Open Middle Light Panel - 24”H Opening - 66” High	EVPLFOX6618	618	645	66	18	2 7/8
		EVPLFOX6624	712	746	66	24	2 7/8
		EVPLFOX6630	834	873	66	30	2 7/8
		EVPLFOX6636	911	958	66	36	2 7/8
		EVPLFOX6642	1024	1076	66	42	2 7/8
		EVPLFOX6648	1094	1152	66	48	2 7/8
		EVPLFOX6654	1210	1273	66	54	2 7/8
		EVPLFOX6660	1322	1392	66	60	2 7/8

**EVPFANR - SEGMENTED NO RACEWAY PANEL**

- Segmented No Raceway panel incorporates fabric modules within steel frame.
- There is no base raceway in No Raceway Panels to accommodate electric.
- No Raceway connectors to be used.
- Fabric covered modules are tackable and acoustical.
- Each side of fabric module may have different fabric within the same grade at no charge.
- If different grades of fabric are used, the entire module must be price at highest grade.
- Aluminum low profile top and bottom cap is included.
- Stackability: Evolve panels can be increased in height in 6”H, 12”H, 18”H, 24”H increments. See module listing for part numbers See Extension Modules for part numbers.

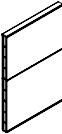
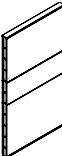
	DESCRIPTION	PRODUCT CODE	LIST PRICE		DIMENSIONS/INCHES		
			Gr1	Gr2	H	W	D
	Segmented NR Panel - 30" High	EVPPFA3018NR	397	416	30	18	2 7/8
		EVPPFA3024NR	412	439	30	24	2 7/8
		EVPPFA3030NR	463	489	30	30	2 7/8
		EVPPFA3036NR	499	531	30	36	2 7/8
		EVPPFA3042NR	534	573	30	42	2 7/8
		EVPPFA3048NR	587	631	30	48	2 7/8
		EVPPFA3054NR	636	683	30	54	2 7/8
	Segmented NR Panel - 42" High	EVPPFA4218NR	440	469	42	18	2 7/8
		EVPPFA4224NR	467	501	42	24	2 7/8
		EVPPFA4230NR	540	582	42	30	2 7/8
		EVPPFA4236NR	580	631	42	36	2 7/8
		EVPPFA4242NR	665	717	42	42	2 7/8
		EVPPFA4248NR	713	776	42	48	2 7/8
		EVPPFA4254NR	789	858	42	54	2 7/8
	Segmented NR Panel - 48" High	EVPPFA4818NR	473	502	48	18	2 7/8
		EVPPFA4824NR	515	544	48	24	2 7/8
		EVPPFA4830NR	592	621	48	30	2 7/8
		EVPPFA4836NR	659	688	48	36	2 7/8
		EVPPFA4842NR	744	773	48	42	2 7/8
		EVPPFA4848NR	829	858	48	48	2 7/8
		EVPPFA4854NR	898	927	48	54	2 7/8
	Segmented NR Panel - 54" High	EVPPFA5418NR	473	511	54	18	2 7/8
		EVPPFA5424NR	515	563	54	24	2 7/8
		EVPPFA5430NR	592	646	54	30	2 7/8
		EVPPFA5436NR	659	723	54	36	2 7/8
		EVPPFA5442NR	744	818	54	42	2 7/8
		EVPPFA5448NR	829	911	54	48	2 7/8
		EVPPFA5454NR	898	986	54	54	2 7/8
	Segmented NR Panel - 66" High	EVPPFA6618NR	595	642	66	18	2 7/8
		EVPPFA6624NR	639	697	66	24	2 7/8
		EVPPFA6630NR	711	777	66	30	2 7/8
		EVPPFA6636NR	831	912	66	36	2 7/8
		EVPPFA6642NR	936	1027	66	42	2 7/8
		EVPPFA6648NR	1006	1107	66	48	2 7/8
		EVPPFA6654NR	1091	1204	66	54	2 7/8
EVPPFA6660NR	1182	1306	66	60	2 7/8		



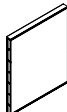
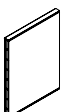
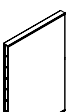
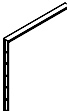
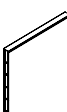

**EVPFAMNR - MONOLITHIC NO RACEWAY PANEL**

- Monolithic No Raceway panel incorporates fabric modules within steel frame.
- There is no base raceway in No Raceway Panels to accommodate electric.
- No Raceway connectors to be used.
- Fabric covered modules are tackable and acoustical.
- Each side of fabric module may have different fabric within the same grade at no charge.
- If different grades of fabric are used, the entire module must be price at highest grade.
- Aluminum low profile top and bottom cap is included.
- Stackability: Evolve panels can be increased in height in 6”H, 12”H, 18”H, 24”H increments. See module listing for part numbers See Extension Modules for part numbers.

	DESCRIPTION	PRODUCT CODE	LIST PRICE		DIMENSIONS/INCHES		
			Gr1	Gr2	H	W	D
	Monolithic NR Panel 42" High	EVPFAM4218NR	410	448	42	18	2 7/8
		EVPFAM4224NR	436	483	42	24	2 7/8
		EVPFAM4230NR	502	601	42	30	2 7/8
		EVPFAM4236NR	534	598	42	36	2 7/8
		EVPFAM4242NR	592	671	42	42	2 7/8
		EVPFAM4248NR	642	730	42	48	2 7/8
		EVPFAM4254NR	705	799	42	54	2 7/8
		EVPFAM4260NR	764	865	42	60	2 7/8
	Monolithic NR Panel - 48" High	EVPFAM4818NR	416	454	48	18	2 7/8
		EVPFAM4824NR	455	506	48	24	2 7/8
		EVPFAM4830NR	528	583	48	30	2 7/8
		EVPFAM4836NR	574	638	48	36	2 7/8
		EVPFAM4842NR	639	714	48	42	2 7/8
		EVPFAM4848NR	694	777	48	48	2 7/8
		EVPFAM4854NR	768	863	48	54	2 7/8
		EVPFAM4860NR	834	936	48	60	2 7/8
	Monolithic NR Panel - 54" High	EVPFAM5418NR	421	459	54	18	2 7/8
		EVPFAM5424NR	463	511	54	24	2 7/8
		EVPFAM5430NR	537	594	54	30	2 7/8
		EVPFAM5436NR	595	664	54	36	2 7/8
		EVPFAM5442NR	666	740	54	42	2 7/8
		EVPFAM5448NR	724	806	54	48	2 7/8
		EVPFAM5454NR	789	888	54	54	2 7/8
		EVPFAM5460NR	867	970	54	60	2 7/8
	Monolithic NR Panel - 66" High	EVPFAM6618NR	517	556	66	18	2 7/8
		EVPFAM6624NR	570	620	66	24	2 7/8
		EVPFAM6630NR	639	698	66	30	2 7/8
		EVPFAM6636NR	744	810	66	36	2 7/8
		EVPFAM6642NR	834	909	66	42	2 7/8
		EVPFAM6648NR	904	987	66	48	2 7/8
		EVPFAM6654NR	1006	1097	66	54	2 7/8
		EVPFAM6660NR	1106	1207	66	60	2 7/8
	Monolithic NR Panel - 90" High	EVPFAM9018NR	909	976	90	18	2 7/8
		EVPFAM9024NR	984	1065	90	24	2 7/8
		EVPFAM9030NR	1094	1197	90	30	2 7/8
		EVPFAM9036NR	1274	1387	90	36	2 7/8



**EVPH1SNR - LAMINATE NO RACEWAY - PANEL SINGLE SIDED**

- Laminate No Raceway panel incorporates single sided laminate modules within steel frame.
- Opposite side is fabric covered.
- Laminate faces on all modules provide durable, washable surfaces on One Side of the panel.
- Available in high pressure laminate only.
- If wood grain is selected, grain runs horizontally.
- There is no base raceway in No Raceway Panels to accommodate electric.
- No Raceway connectors to be used.
- If different grades of fabric are used, the entire module must be priced at highest grade.
- An aluminum low profile top and bottom cap is included.
- Stackability: Evolve panels can be increased in height in 6”H, 12”H, 18”H, 24”H increments. See module listing for part numbers.

	DESCRIPTION	PRODUCT CODE	LIST PRICE		DIMENSIONS/INCHES		
			Gr1	Gr2	H	W	D
	Laminate NR Panel - Single Sided - 30" High	EVPH1S3018NR	488	497	30	18	2 7/8
		EVPH1S3024NR	585	597	30	24	2 7/8
		EVPH1S3030NR	679	692	30	30	2 7/8
		EVPH1S3036NR	772	790	30	36	2 7/8
		EVPH1S3042NR	879	893	30	42	2 7/8
		EVPH1S3048NR	954	973	30	48	2 7/8
		EVPH1S3054NR	1052	1078	30	54	2 7/8
		EVPH1S3060NR	1157	1181	30	60	2 7/8
	Laminate NR Panel - Single Sided - 42" High	EVPH1S4218NR	582	596	42	18	2 7/8
		EVPH1S4224NR	691	712	42	24	2 7/8
		EVPH1S4230NR	810	831	42	30	2 7/8
		EVPH1S4236NR	927	955	42	36	2 7/8
		EVPH1S4242NR	1050	1080	42	42	2 7/8
		EVPH1S4248NR	1142	1175	42	48	2 7/8
		EVPH1S4254NR	1266	1304	42	54	2 7/8
		EVPH1S4260NR	1387	1429	42	60	2 7/8
	Laminate NR Panel - Single Sided - 54" High	EVPH1S5418NR	680	695	54	18	2 7/8
		EVPH1S5424NR	821	848	54	24	2 7/8
		EVPH1S5430NR	962	991	54	30	2 7/8
		EVPH1S5436NR	1100	1132	54	36	2 7/8
		EVPH1S5442NR	1245	1286	54	42	2 7/8
		EVPH1S5448NR	1362	1406	54	48	2 7/8
		EVPH1S5454NR	1512	1559	54	54	2 7/8
		EVPH1S5460NR	1662	1715	54	60	2 7/8
	Laminate NR Panel - Single Sided - 66" High	EVPH1S6618NR	842	869	66	18	2 7/8
		EVPH1S6624NR	1012	1045	66	24	2 7/8
		EVPH1S6630NR	1183	1222	66	30	2 7/8
		EVPH1S6636NR	1365	1407	66	36	2 7/8
		EVPH1S6642NR	1550	1598	66	42	2 7/8
		EVPH1S6648NR	1550	1598	66	48	2 7/8
		EVPH1S6654NR	1880	1937	66	54	2 7/8
		EVPH1S6660NR	2067	2133	66	60	2 7/8

**EVPH2SNR - LAMINATE NO RACEWAY - PANEL DOUBLE SIDED**

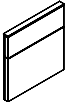
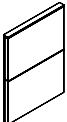
- Laminate No Raceway panel incorporates double sided laminate modules, within steel frame.
- Laminate faces on all modules provide durable, washable surfaces on both sides of the panel.
- Available in high pressure laminate only.
- If wood grain is selected, grain runs horizontally.
- There is no base raceway in No Raceway Panels to accommodate electric.
- No Raceway connectors to be used.
- If different grades of fabric are used, the entire module must be priced at highest grade.
- An aluminum low profile top and bottom cap is included.
- Stackability: Evolve panels can be increased in height in 6”H, 12”H, 18”H, 24”H increments. See module listing for part numbers.

	DESCRIPTION	PRODUCT CODE	LIST PRICE	DIMENSIONS/INCHES		
				H	W	D
	Laminate NR Panel - Double Sided - 30" High	EVPH2S3018NR	666	30	18	2 7/8
		EVPH2S3024NR	666	30	24	2 7/8
		EVPH2S3030NR	786	30	30	2 7/8
		EVPH2S3036NR	898	30	36	2 7/8
		EVPH2S3042NR	1021	30	42	2 7/8
		EVPH2S3048NR	1141	30	48	2 7/8
		EVPH2S3054NR	1264	30	54	2 7/8
EVPH2S3060NR	1365	30	60	2 7/8		
	Laminate NR Panel - Double Sided - 42" High	EVPH2S4218NR	647	42	18	2 7/8
		EVPH2S4224NR	786	42	24	2 7/8
		EVPH2S4230NR	926	42	30	2 7/8
		EVPH2S4236NR	1075	42	36	2 7/8
		EVPH2S4242NR	1225	42	42	2 7/8
		EVPH2S4248NR	1372	42	48	2 7/8
		EVPH2S4254NR	1509	42	54	2 7/8
EVPH2S4260NR	1641	42	60	2 7/8		
	Laminate NR Panel - Double Sided - 54" High	EVPH2S5418NR	758	54	18	2 7/8
		EVPH2S5424NR	928	54	24	2 7/8
		EVPH2S5430NR	1099	54	30	2 7/8
		EVPH2S5436NR	1276	54	36	2 7/8
		EVPH2S5442NR	1458	54	42	2 7/8
		EVPH2S5448NR	1639	54	48	2 7/8
		EVPH2S5454NR	1806	54	54	2 7/8
EVPH2S5460NR	1963	54	60	2 7/8		
	Laminate NR Panel - Double Sided - 66" High	EVPH2S6618NR	954	66	18	2 7/8
		EVPH2S6624NR	1172	66	24	2 7/8
		EVPH2S6630NR	1387	66	30	2 7/8
		EVPH2S6636NR	1610	66	36	2 7/8
		EVPH2S6642NR	1844	66	42	2 7/8
		EVPH2S6648NR	2067	66	48	2 7/8
		EVPH2S6654NR	2282	66	54	2 7/8
EVPH2S6660NR	2491	66	60	2 7/8		

**EVPGTNR - FULLY GLAZED SEGMENTED NO RACEWAY PANEL**

- Fully Glazed Segmented No Raceway Panels are incorporated in solid steel frame
- There is no base raceway in No Raceway Panels to accommodate electric
- No Raceway connectors to be used
- Standard in clear (CLR) glass.
- Frosted glass (FRST) 40% upcharge
- Aluminum low profile top and bottom cap is included
- Stackability: Evolve panels can be increased in height in 6”H, 12”H, 18”H, 24”H increments. See module listing for part numbers.

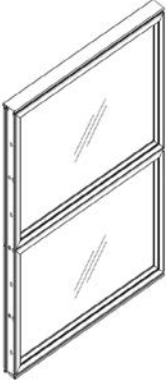
DESCRIPTION	PRODUCT CODE	LIST PRICE	DIMENSIONS/INCHES		
			H	W	D
 Glazed Segmented NR Panel 48” H	EVPGT4818NR	801	48	18	2 7/8
	EVPGT4824NR	984	48	24	2 7/8
	EVPGT4830NR	1089	48	30	2 7/8
	EVPGT4836NR	1188	48	36	2 7/8
	EVPGT4842NR	1316	48	42	2 7/8
	EVPGT4848NR	1467	48	48	2 7/8
	EVPGT4854NR	1615	48	54	2 7/8
	EVPGT4860NR	1762	48	60	2 7/8

**EVPXGTNR - FULLY GLAZED MONOLITHIC NO RACEWAY PANEL**

- Fully Glazed Monolithic No Raceway Panels are incorporated in solid steel frame.
- There is no base raceway in No Raceway Panels to accommodate electric.
- No Raceway connectors to be used.
- Standard in clear (CLR) glass.
- Frosted glass (FRST) 40% upcharge.
- Size 90”x36”W is maximum size allowed.
- Panel height to align with standard door height.
- Aluminum low profile top and bottom cap is included.
- Stackability: Evolve panels can be increased in height in 6”H, 12”H, 18”H, 24”H increments. See module listing for part numbers.

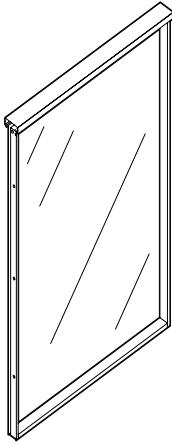
DESCRIPTION	PRODUCT CODE	LIST PRICE	DIMENSIONS/INCHES		
			H	W	D
 Glazed Monolithic NR Panel 90” High	EVPXGT9018NR	1018	90	18	2 7/8
	EVPXGT9024NR	1161	90	24	2 7/8
	EVPXGT9030NR	1317	90	30	2 7/8
	EVPXGT9036NR	1424	90	36	2 7/8

**EVPICNR - INLINE CONNECTOR NO RACEWAY PANEL**

- Connects two No Raceway Panels in a straight run.
- Provides slotted support for worksurfaces and hang on components.
- Includes one slotted connector with leveling glide and connecting hardware.
- Connectors are available without slots, as a special at no extra charge. Contact Customer Support.

	DESCRIPTION	PRODUCT CODE	LIST PRICE	DIMENSIONS/INCHES		
				H	W	D
	Inline Connector No Raceway Panel	EVPIC30NR	83	30	2	
	To be used only with 90" H NR Glazed Panels	EVPIC42NR	97	42	2	
		EVPIC48NR	101	48	2	
		EVPIC54NR	104	54	2	
		EVPIC66NR	116	66	2	

**EVPICPNR - INLINE CONNECTOR PANEL - NO RACEWAY PANEL**

- Connects Panel to No Raceway panel in straight run.
- Provides slotted support for worksurfaces and hang on components.
- Includes one slotted connector with leveling glide and connecting hardware.
- Connectors are available without slots, as a special at no extra charge. Contact Customer Support.
- Note: Allows to connect panel to NR panel in straight run.

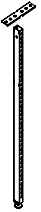
	DESCRIPTION	PRODUCT CODE	LIST PRICE	DIMENSIONS/INCHES		
				H	W	D
	Inline Connector Panel - No Raceway Panel	EVPIC30PNR	80	30	2	
		EVPIC42PNR	93	42	2	
		EVPIC48PNR	97	48	2	
		EVPIC54PNR	99	54	2	
		EVPIC66PNR	110	66	2	

**EVPIC90NR - INLINE CONNECTOR NO RACEWAY PANEL**

- Connects two 90" H No Raceway panel in straight run.
- Includes one slotted connector with leveling glide and connecting hardware.
- Connectors are without slots
- To be used only with 90" H NR Glazed Panels.

	DESCRIPTION	PRODUCT CODE	LIST PRICE	DIMENSIONS/INCHES		
				H	W	D
	Inline Connector No Raceway Panel	EVPIC90NR	174	90	2	

**EVVIC90PNR - INLINE CONNECTOR PANEL - NO RACEWAY PANEL**

- Connects 90" H No Raceway panel to 90" H door in straight run.
- Includes one non slotted connector with leveling glide and connecting hardware
- Connectors are without slots.
- Note: To be used only with 90" H NR Glazed Panels and 90" H door

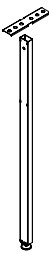
	DESCRIPTION	PRODUCT CODE	LIST PRICE	DIMENSIONS/INCHES		
				H	W	D
	Inline Connector Panel - No Raceway Panel	EVVIC90PNR	174	90	2	

**EVVVCNR - INLINE VARIABLE HEIGHT CONNECTOR NO RACEWAY PANEL**

- Connects two No Raceway panels of differing height in straight run.
- Connector must reference taller panel.
- Can be used for any variation of panel height.
- Variable height trim must be ordered separately (see EVPTVA).
- Provides slotted support for worksurfaces and hang on components.
- Includes one slotted connector with leveling glide and connecting hardware.
- Connectors are available without slots, as a special at no extra charge. Contact customer support..

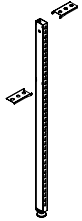
	DESCRIPTION	PRODUCT CODE	LIST PRICE	DIMENSIONS/INCHES		
				H	W	D
	Inline Variable Height Connector	EVVVC42NR	104	42	2	
	No Raceway Panel	EVVVC48NR	106	48	2	
		EVVVC54NR	109	54	2	
		EVVVC66NR	117	66	2	

**EVVVC66PNR - INLINE VARIABLE HEIGHT CONNECTOR PANEL - NO RACEWAY PANEL**

- Connects Panel to No Raceway panels of differing height in straight run.
- Connector must reference taller panel.
- Can be used for any variation of panel height.
- Variable height trim must be ordered separately (see EVPTVA).
- Provides slotted support for worksurfaces and hang on components.
- Includes one slotted connector with leveling glide and connecting hardware.
- Connectors are available without slots, as a special at no extra charge. Contact customer support.
- Note: Allows to connect panel to NR panel in straight run

	DESCRIPTION	PRODUCT CODE	LIST PRICE	DIMENSIONS/INCHES		
				H	W	D
	Inline Variable Height Connector	EVVVC42PNR	110	42	2	
	Panel - No Raceway Panel	EVVVC48PNR	117	48	2	
		EVVVC54PNR	132	54	2	
		EVVVC66PNR	146	66	2	

**EVERANR - END OF RUN POST KIT FOR NO RACEWAY PANEL**

- Connects at end of No Raceway panel and can attach to a panel to fixed wall.
- Adds 1" to width of panel run.
- Provides slotted support for worksurfaces and hang on components.
- Includes one slotted connector with leveling glide and connecting hardware and glide and connecting hardware and trim kit.
- Can be attached to face of another panel to provide off modular connection.
- Connectors are available without slots, as a special at no extra charge. Contact customer support.

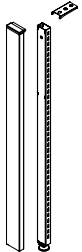
DESCRIPTION	PRODUCT CODE	LIST PRICE	DIMENSIONS/INCHES		
			H	W	D
 End End of Run Post Kit No Raceway Panel	EVPERA30NR	101	30	2	
	EVPERA42NR	116	42	2	
	EVPERA48NR	122	48	2	
	EVPERA54NR	137	54	2	
	EVPERA66NR	152	66	2	

**EVPERA90NR - END OF RUN POST KIT FOR NO RACEWAY PANEL**

- Connects two 90" H No Raceway panel and can attach to a panel to fixed wall.
- Adds 1" to width of panel run.
- Includes Non-Slotted connector with leveling glide and connecting hardware and trim kit.
- Can be attached to face of another panel to provide off modular connection.
- Connectors are without slots.
- To be used only with 90" H NR Glazed Panels.

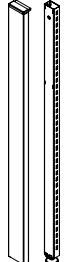
DESCRIPTION	PRODUCT CODE	LIST PRICE	DIMENSIONS/INCHES		
			H	W	D
 End End of Run Post Kit To be used only with 90" H NR Glazed Panels	EVPERA90NR	218	66	2	

**EVPCPA1NR - ONE WAY CORNER POST NO RACEWAY PANEL**

- Connects at end of No Raceway panel run in place of EVPERA- End of run post kit.
- Should not be used to attach panel to fixed wall.
- Post and connecting hardware add 3.25" to power beam run.
- Provides slotted support for worksurfaces and hang on components.
- Includes post, panel connectors and power beam connectors, post with trim all around, levelling glide, hardware and trim kit.
- Connectors are available without slots, as a special at no extra charge. Contact customer support.

	DESCRIPTION	PRODUCT CODE	LIST PRICE	DIMENSIONS/INCHES		
				H	W	D
	One Way Corner Post	EVPCPA130NR	134	30	2 7/8	
	No Raceway Panel	EVPCPA142NR	152	42	2 7/8	
		EVPCPA148NR	179	48	2 7/8	
		EVPCPA154NR	204	54	2 7/8	
		EVPCPA166NR	250	66	2 7/8	

**EVPCPA190NR - ONE WAY CORNER POST NO RACEWAY PANEL**

- Connects at end of 90" H No Raceway panel run in place of EVPERA - End of run post kit.
- Should not be used to attach panel to fixed wall.
- Post and connecting hardware add 3.25" to power beam run.
- Includes post, panel connectors and power beam connectors, post with trim all around, levelling glide, hardware and trim kit.
- Connectors are without slots.
- To be used only with 90" H NR Glazed Panels.

	DESCRIPTION	PRODUCT CODE	LIST PRICE	DIMENSIONS/INCHES		
				H	W	D
	One Way Corner Post	EVPCPA190NR	369	90	2 7/8	
	No Raceway Panel					
	To be used only with 90" H NR Glazed Panels					

**EVPIPA2NR - INLINE TWO WAY CORNER POST NO RACEWAY PANEL**

- Connects two No Raceway panel of equal height in straight run.
- Post and connecting hardware add 3.25" to power beam run.
- Provides slotted support for worksurfaces and hang on components.
- Includes post, panel connectors and power beam connectors, post with trim all around, levelling glide, hardware and trim kit.
- Connectors are available without slots, as a special at no extra charge. Contact customer support.

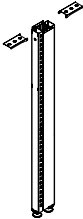
	DESCRIPTION	PRODUCT CODE	LIST PRICE	DIMENSIONS/INCHES		
				H	W	D
	Inline Two Way Corner Post	EVPIPA230NR	183	30	2 7/8	
	No Raceway Panel	EVPIPA242NR	232	42	2 7/8	
		EVPIPA248NR	253	48	2 7/8	
		EVPIPA254NR	277	54	2 7/8	
		EVPIPA266NR	328	66	2 7/8	

**EVPIPA290NR - INLINE TWO WAY CORNER POST NO RACEWAY PANEL**

- Connects two No Raceway panel of equal height in a straight run.
- Post and connecting hardware add 3.25" to power beam run.
- Includes post, panel connectors and power beam connectors, post with trim all around, levelling glide, hardware and trim kit.
- Connectors are without slots.
- To be used only with 90" H NR Glazed Panels.

	DESCRIPTION	PRODUCT CODE	LIST PRICE	DIMENSIONS/INCHES		
				H	W	D
	Inline Two Way Corner Post No Raceway Panel To be used only with 90" H NR Glazed Panels	EVPIPA290NR	493	90	2 7/8	

**EVPCPA2PNR - TWO WAY CORNER POST NO RACEWAY PANEL-PANEL**

- Connects No Raceway panel and Raceway Panel of equal height in 90 degree configuration.
- Post and connecting hardware add 3.25" to power beam run.
- Provides slotted support for worksurfaces and hang on components.
- Includes post, panel connectors and power beam connectors, post with trim all around, levelling glide, hardware and trim kit.
- Connectors are available without slots, as a special at no extra charge. Contact customer support.

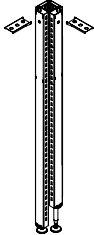
	DESCRIPTION	PRODUCT CODE	LIST PRICE	DIMENSIONS/INCHES		
				H	W	D
	Two Way Corner Post	EVPCPA230PNR	188	30	2 7/8	
	No Raceway Panel	EVPCPA242PNR	235	42	2 7/8	
		EVPCPA248PNR	250	48	2 7/8	
		EVPCPA254PNR	289	54	2 7/8	
		EVPCPA266PNR	344	66	2 7/8	

**EVPCPA290NR - TWO WAY CORNER POST NO RACEWAY PANEL**

- Connects two 90" H No Raceway panels of equal height in "T" configuration.
- Post and connecting hardware add 3.25" to power beam run.
- Includes post, panel connectors and power beam connectors, post with trim all around, levelling glide, hardware and trim kit.
- Connectors are without slots.
- To be used only with 90" H NR Glazed Panels.

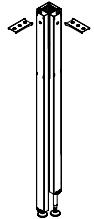
	DESCRIPTION	PRODUCT CODE	LIST PRICE	DIMENSIONS/INCHES		
				H	W	D
	Two Way Corner Post No Raceway Panel To be used only with 90" H NR Glazed Panels	EVPCPA290NR	494	90	2 7/8	

**EVPCPA3PNR - THREE WAY CORNER POST NO RACEWAY PANEL-PANEL-NO RACEWAY PANEL**

- Connects two No Raceway panels and Raceway Panels of equal height in "T" configuration.
- Post and connecting hardware add 3.25" to power beam run.
- Provides slotted support for worksurfaces and hang on components.
- Includes post, panel connectors and power beam connectors, post with trim all around, levelling glide, hardware and trim kit.
- Connectors are available without slots, as a special at no extra charge. Contact customer support.

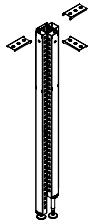

DESCRIPTION	PRODUCT CODE	LIST PRICE	DIMENSIONS/INCHES		
			H	W	D
Three Way Corner Post	EVPCPA330PNR	234	30	2 7/8	
No Raceway Panel	EVPCPA342PNR	312	42	2 7/8	
	EVPCPA348PNR	344	48	2 7/8	
	EVPCPA354PNR	377	54	2 7/8	
	EVPCPA366PNR	445	66	2 7/8	

**EVPCPA3PNRP - THREE WAY CORNER POST PANEL-NO RACEWAY PANEL-PANEL**

- Connects two panels and No raceway Panel of equal height in "T" configuration.
- Post and connecting hardware add 3.25" to power beam run.
- Provides slotted support for worksurfaces and hang on components.
- Includes post, panel connectors and power beam connectors, post with trim all around, levelling glide, hardware and trim kit.
- Connectors available without slots, as a special at no extra charge. Contact CustomerCare

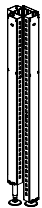

DESCRIPTION	PRODUCT CODE	LIST PRICE	DIMENSIONS/INCHES		
			H	W	D
Three Way Corner Post	EVPCPA330PNRP	234	30	2 7/8	
No Raceway Panel	EVPCPA342PNRP	312	42	2 7/8	
	EVPCPA348PNRP	344	48	2 7/8	
	EVPCPA354PNRP	377	54	2 7/8	
	EVPCPA366PNRP	445	66	2 7/8	

**EVPCPA390NR - THREE WAY CORNER POST NO RACEWAY PANEL**

- Connects two 90" H No Raceway panels of equal height in "T" configuration.
- Post and connecting hardware add 3.25" to power beam run.
- Includes post, panel connectors and power beam connectors, post with trim all around, levelling glide, hardware and trim kit.
- Connectors are without slots.
- To be used only with 90" H NR Glazed Panels.

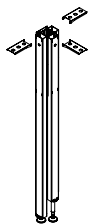

DESCRIPTION	PRODUCT CODE	LIST PRICE	DIMENSIONS/INCHES		
			H	W	D
Three Way Corner Post	EVPCPA390NR	623	90	2 7/8	
No Raceway Panel					
To be used only with 90" H NR Glazed Panels					

**EVPCPA4PNR - FOUR WAY CORNER POST NO RACEWAY PANEL-PANEL-NO RACEWAY PANEL-PANEL**

- Connects two No Raceway panels and two Raceway panels of equal height in "+" configuration.
- Post and connecting hardware add 3.25" to power beam run.
- Provides slotted support for worksurfaces and hang on components.
- Includes post, panel connectors and power beam connectors, post with trim all around, levelling glide, hardware and trim kit.
- Connectors are available without slots, as a special at no extra charge. Contact customer support.

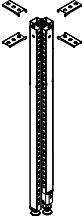
	DESCRIPTION	PRODUCT CODE	LIST PRICE	DIMENSIONS/INCHES		
				H	W	D
	Four Way Corner Post	EVPCPA430PNR	286	30	2 7/8	
	No Raceway Panel	EVPCPA442PNR	365	42	2 7/8	
		EVPCPA448PNR	405	48	2 7/8	
		EVPCPA454PNR	441	54	2 7/8	
		EVPCPA466PNR	517	66	2 7/8	

**EVPCPA490NR - FOUR WAY CORNER POST NO RACEWAY PANEL**

- Connects four 90" H No Raceway panels of equal height in "+" configuration.
- Post and connecting hardware add 3.25" to power beam run.
- Includes post, panel connectors and power beam connectors, post with trim all around, levelling glide, hardware and trim kit.
- Connectors are without slots.
- To be used only with 90" H NR Glazed Panels.

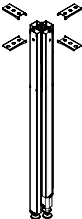
	DESCRIPTION	PRODUCT CODE	LIST PRICE	DIMENSIONS/INCHES		
				H	W	D
	Four Way Corner Post No Raceway Panel To be used only with 90" H NR Glazed Panels	EVPCPA490NR	715	90	2 7/8	

**EVLEPDSNC - LAMINATE DOUBLE SIDED GALLERY PANEL, FINISHED ENDS**

- Attaches to end of run connector with “U” channel.
- To be installed at end of panel run.
- Finished in thermally fused laminate.
- No connection on both sides.
- Laminate Gallery Panel height is inclusive of panel glides extended to their full height.
- If wood grain is selected, grain runs horizontally.
- End of run connector with “U” channel and bottom connecting brackets to be ordered separately.

	DESCRIPTION	PRODUCT CODE	LIST PRICE LP	DIMENSIONS/INCHES		
				H	W	D
	Laminate Double Sided Gallery Panel	EVLEPDS4251NC	741	42	51	1
	Finished Ends - 42” High	EVLEPDS4263NC	965	42	63	1
		EVLEPDS4275NC	1188	42	75	1
	Laminate Double Sided Gallery Panel	EVLEPDS4851NC	807	48	51	1
	Finished Ends - 48” High	EVLEPDS4863NC	1069	48	63	1
		EVLEPDS4875NC	1299	48	75	1
	Laminate Double Sided Gallery Panel	EVLEPDS5451NC	937	54	51	1
	Finished Ends - 54” High	EVLEPDS5463NC	1224	54	63	1
		EVLEPDS5475NC	1415	54	75	1





**EVLEPDS - LAMINATE DOUBLE SIDED GALLERY PANEL, CONNECTOR ENDS**

- Attaches to end of run connector with “U” channel.
- To be installed at end of panel run.
- Finished in thermally fused laminate.
- Locking connection both sides.
- Laminate Gallery Extension Panel height is inclusive of panel glides extended to their full height.
- If wood grain is selected, grain runs horizontally.
- End of run connector with “U” channel and bottom connecting brackets to be ordered separately.

	DESCRIPTION	PRODUCT CODE	LIST PRICE LP	DIMENSIONS/INCHES		
				H	W	D
	Laminate Double Sided Gallery	EVLEPDS4251	741	42	51	1
	Panel - Connector Ends - 42” High	EVLEPDS4263	965	42	63	1
		EVLEPDS4275	1188	42	75	1
	Laminate Double Sided Gallery	EVLEPDS4851	807	48	51	1
	Panel - Connector Ends - 48” High	EVLEPDS4863	1069	48	63	1
		EVLEPDS4875	1299	48	75	1
	Laminate Double Sided Gallery	EVLEPDS5451	937	54	51	1
	Panel - Connector Ends - 54” High	EVLEPDS5463	1224	54	63	1
		EVLEPDS5475	1415	54	75	1

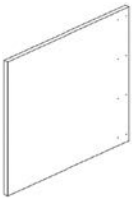

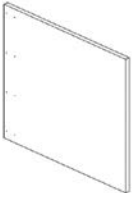

**EVLEPSSNC - LAMINATE SINGLE SIDED GALLERY PANEL, FINISHED ENDS**

- Attaches to end of run connector with "U" channel.
- To be installed at end of panel run on one side.
- Finished in thermally fused laminate.
- No connection both sides.
- Laminate Gallery Extension Panel height is inclusive of panel glides extended to their full height.
- If wood grain is selected, grain runs horizontally.
- End of run connector with "U" channel and bottom connecting brackets to be ordered separately.

	DESCRIPTION	PRODUCT CODE	LIST PRICE LP	DIMENSIONS/INCHES		
				H	W	D
	Laminate Single Sided Gallery Panel - Finished Ends - 42" High	EVLEPSSL4227NC	482	42	27	1
		EVLEPSSL4233NC	538	42	33	1
		EVLEPSSL4239NC	604	42	39	1
		EVLEPSSL4245NC	692	42	45	1
		EVLEPSSL4251NC	741	42	51	1
	Laminate Single Sided Gallery Panel - Finished Ends - 48" High	EVLEPSSL4827NC	527	48	27	1
		EVLEPSSL4833NC	598	48	33	1
		EVLEPSSL4839NC	669	48	39	1
		EVLEPSSL4845NC	741	48	45	1
		EVLEPSSL4851NC	839	48	51	1
	Laminate Single Sided Gallery Panel - Finished Ends - 54" High	EVLEPSSL5427NC	579	54	27	1
		EVLEPSSL5433NC	662	54	33	1
		EVLEPSSL5439NC	754	54	39	1
		EVLEPSSL5445NC	882	54	45	1
		EVLEPSSL5451NC	937	54	51	1
	Laminate Single Sided Gallery Panel - Finished Ends - 42" High	EVLEPSSR4227NC	482	42	27	1
		EVLEPSSR4233NC	538	42	33	1
		EVLEPSSR4239NC	604	42	39	1
		EVLEPSSR4245NC	692	42	45	1
		EVLEPSSR4251NC	741	42	51	1
	Laminate Single Sided Gallery Panel - Finished Ends - 48" High	EVLEPSSR4827NC	527	48	27	1
		EVLEPSSR4833NC	598	48	33	1
		EVLEPSSR4839NC	669	48	39	1
		EVLEPSSR4845NC	741	48	45	1
		EVLEPSSR4851NC	839	48	51	1
	Laminate Single Sided Gallery Panel - Finished Ends - 54" High	EVLEPSSR5427NC	807	54	27	1
		EVLEPSSR5433NC	662	54	33	1
		EVLEPSSR5439NC	754	54	39	1
		EVLEPSSR5445NC	882	54	45	1
		EVLEPSSR5451NC	937	54	51	1

**EVLEPSS - LAMINATE SINGLE SIDED GALLERY PANEL, CONNECTOR END**

- Attaches to end of run connector with "U" channel.
- To be installed at end of panel run on one side.
- Finished in thermally fused laminate.
- Locking connection on one side.
- Laminate Gallery Extension Panel height is inclusive of panel glides extended to their full height.
- If wood grain is selected, grain runs horizontally.
- End of run connector with "U" channel and bottom connecting brackets to be ordered separately

	DESCRIPTION	PRODUCT CODE	LIST PRICE	DIMENSIONS/INCHES		
			LP	H	W	D
	Laminate Single Sided Gallery Panel - Connector Ends - 42" High	EVLEPSSL4227	482	42	27	1
		EVLEPSSL4233	538	42	33	1
		EVLEPSSL4239	604	42	39	1
		EVLEPSSL4245	692	42	45	1
		EVLEPSSL4251	741	42	51	1
	Laminate Single Sided Gallery Pannel - Connector Ends - 48" High	EVLEPSSL4827	527	48	27	1
		EVLEPSSL4833	598	48	33	1
		EVLEPSSL4839	669	48	39	1
		EVLEPSSL4845	741	42	45	1
		EVLEPSSL4851	839	42	51	1
	Laminate Single Sided Gallery Pannel - Connector Ends - 54" High	EVLEPSSL5427	579	54	27	1
		EVLEPSSL5433	662	54	33	1
		EVLEPSSL5439	754	42	39	1
		EVLEPSSL5445	882	54	45	1
		EVLEPSSL5451	937	42	51	1
	Laminate Single Sided Gallery Pannel - Connector Ends - 42" High	EVLEPSSR4227	482	42	27	1
		EVLEPSSR4233	538	42	33	1
		EVLEPSSR4239	604	42	39	1
		EVLEPSSR4245	692	42	45	1
		EVLEPSSR4251	741	42	51	1
	Laminate Single Sided Gallery Pannel - Connector Ends - 48" High	EVLEPSSR4827	527	48	27	1
		EVLEPSSR4833	598	48	33	1
		EVLEPSSR4839	669	48	39	1
		EVLEPSSR4845	741	42	45	1
		EVLEPSSR4851	839	42	51	1
	Laminate Single Sided Gallery Pannel - Connector Ends - 54" High	EVLEPSSR5427	579	54	27	1
		EVLEPSSR5433	662	54	33	1
		EVLEPSSR5439	754	54	39	1
		EVLEPSSR5445	882	42	45	1
		EVLEPSSR5451	937	42	51	1

**EVLEPDCNC - LAMINATE DOUBLE SIDED MIDDLE GALLERY PANEL, BASE POWER, FINISHED ENDS**

- Attaches in middle of panel run with connector with "U" channel.
- To be installed in middle between two panels in straight run.
- Finished in thermally fused laminate.
- Locking connection on both side.
- Laminate Gallery Panel height is inclusive of panel glides extended to their full height.
- If wood grain is selected, grain runs horizontally.
- End of run connector with "U" channel and bottom connecting brackets to be ordered separately.

	DESCRIPTION	PRODUCT CODE	LIST PRICE LP	DIMENSIONS/INCHES		
				H	W	D
	Laminate Double Sided Gallery Panel Finished Ends - 42" High	EVLEPDC4251NC	937	42	51	1
		EVLEPDC4263NC	965	42	63	1
		EVLEPDC4275NC	1188	42	75	1
	Laminate Double Sided Gallery Panel Finished Ends - 48" High	EVLEPDC4851NC	807	48	51	1
		EVLEPDC4863NC	1069	48	63	1
		EVLEPDC4875NC	1299	48	75	1
	Laminate Double Sided Gallery Panel Finished Ends - 54" High	EVLEPDC4851NC	807	54	51	1
		EVLEPDC4863NC	1069	54	63	1
		EVLEPDC4875NC	1299	54	75	1

**EVICLXPNC - LAMINATE DOUBLE SIDED MIDDLE GALLERY PANEL, BELTLINE POWER, FINISHED ENDS**

- Attaches in middle of panel run with connector with "U" channel
- To be installed in middle between two beltline panels in straight run .
- Finished in thermally fused laminate.
- No connection both sides.
- Laminate Gallery Panel height is inclusive of panel glides extended to their full height.
- If wood grain is selected, grain runs horizontally.
- End of run connector with "U" channel and bottom connecting brackets to be ordered separately.

	DESCRIPTION	PRODUCT CODE	LIST PRICE LP	DIMENSIONS/INCHES		
				H	W	D
	Laminate Double Sided Middle Gallery Panel - Finished Ends - 42" High	EVICLXP4251NC	741	42	51	1
		EVICLXP4263NC	965	42	63	1
		EVICLXP4275NC	1188	42	75	1
	Laminate Double Sided Middle Gallery Panel - Finished Ends - 48" High	EVICLXP4851NC	807	48	51	1
		EVICLXP4863NC	1069	48	63	1
		EVICLXP4875NC	1299	48	75	1
	Laminate Double Sided Middle Gallery Panel - Finished Ends - 54" High	EVICLXP5451NC	937	54	51	1
		EVICLXP5463NC	1224	54	63	1
		EVICLXP5475NC	1415	54	75	1

**EVLEPDC - LAMINATE DOUBLE SIDED MIDDLE GALLERY PANEL, BASE POWER, CONNECTOR ENDS**

- Attaches to end of run connector with “U” channel.
- To be installed in middle between two panels in straight run.
- Finished in thermally fused laminate.
- Locking connection both sides.
- Laminate Gallery Extension Panel height is inclusive of panel glides extended to their full height.
- If wood grain is selected, grain runs horizontally.
- End of run connector with “U” channel and bottom connecting brackets to be ordered separately.

	DESCRIPTION	PRODUCT CODE	LIST PRICE	DIMENSIONS/INCHES		
			LP	H	W	D
	Laminate Double Sided Middle Gallery Panel - Connector End - 42” High	EVLEPDC4251	741	42	51	1
		EVLEPDC4263	965	42	63	1
		EVLEPDC4275	1188	42	75	1
	Laminate Single Sided Middle Gallery Panel - Connector End - 48” High	EVLEPDC4851	807	48	51	1
		EVLEPDC4863	1069	48	63	1
		EVLEPDC4875	1299	48	75	1
	Laminate Single Sided Middle Gallery Panel - Connector End - 54” High	EVLEPDC5451	937	54	51	1
		EVLEPDC5463	1224	54	63	1
		EVLEPDC5475	1415	54	75	1

**EVICLXP - LAMINATE DOUBLE SIDED MIDDLE GALLERY PANEL, BELTLINE POWER, CONNECTOR ENDS**

- Attaches in middle of panel run with connector with “U” channel.
- To be installed in middle between two panels in straight run on one side.
- Finished in thermally fused laminate.
- Locking connection on both sides.
- Laminate Gallery Panel height is inclusive of panel glides extended to their full height.
- If wood grain is selected, grain runs horizontally.
- End of run connector with “U” channel and bottom connecting brackets to be ordered separately.

	DESCRIPTION	PRODUCT CODE	LIST PRICE	DIMENSIONS/INCHES		
			LP	H	W	D
	Laminate Double Sided Gallery Panel Connector Ends - 42” High	EVICLXP4251	741	42	51	1
		EVICLXP4263	965	42	63	1
		EVICLXP4275	1188	42	75	1
	Laminate Double Sided Gallery Panel Connector Ends - 48” High	EVICLXP4851	807	48	51	1
		EVICLXP4863	1069	48	63	1
		EVICLXP4875	1299	48	75	1
	Laminate Double Sided Gallery Panel Connector Ends - 54” High	EVICLXP5451	937	54	51	1
		EVICLXP5463	1224	54	63	1
		EVICLXP5475	1415	42	75	1

**EVLEPSCNC - LAMINATE SINGLE SIDED MIDDLE GALLERY PANEL, BASE POWER, FINISHED ENDS**

- Attaches in middle of panel run with connector with "U" channel.
- To be installed in middle between two panels in straight run on one side.
- Cut out for electrics at base height.
- Finished in thermally fused laminate.
- No connection both sides.
- Laminate Gallery Panel height is inclusive of panel glides extended to their full height.
- If wood grain is selected, grain runs horizontally.
- End of run connector with "U" channel and bottom connecting brackets to be ordered separately.

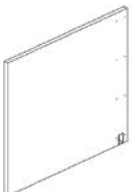
	DESCRIPTION	PRODUCT CODE	LIST PRICE LP	DIMENSIONS/INCHES		
				H	W	D
	Laminate Single Sided Gallery Panel - Finished End - 42" High	EVLEPSC4227NC	482	42	27	1
		EVLEPSC4233NC	538	42	33	1
		EVLEPSC4239NC	604	42	39	1
		EVLEPSC4245NC	692	42	45	1
		EVLEPSC4251NC	741	42	51	1
	Laminate Single Sided Gallery Panel - Finished End - 48" High	EVLEPSC4827NC	527	48	27	1
		EVLEPSC4833NC	598	48	33	1
		EVLEPSC4839NC	669	48	39	1
		EVLEPSC4845NC	741	48	45	1
		EVLEPSC4851NC	839	48	51	1
	Laminate Single Sided Gallery Panel - Finished End - 54" High	EVLEPSC5427NC	579	54	27	1
		EVLEPSC5433NC	662	54	33	1
		EVLEPSC5439NC	754	54	39	1
		EVLEPSC5445NC	882	54	45	1
		EVLEPSC5451NC	937	54	51	1

**EVLEPSC - LAMINATE SINGLE SIDED MIDDLE GALLERY PANEL, BASE POWER, CONNECTOR END**

- Attaches in middle of panel run with connector with "U" channel.
- To be installed in middle between two panels in straight run on one side.
- Finished in thermally fused laminate.
- Locking connection on one side.
- Laminate Gallery Panel height is inclusive of panel glides extended to their full height.
- If wood grain is selected, grain runs horizontally.
- End of run connector with "U" channel and bottom connecting brackets to be ordered separately.

	DESCRIPTION	PRODUCT CODE	LIST PRICE LP	DIMENSIONS/INCHES		
				H	W	D
	Laminate Single Sided Middle Gallery Panel - Connector Ends - 42" High	EVLEPSC4227	482	42	27	1
		EVLEPSC4233	538	42	33	1
		EVLEPSC4239	604	42	39	1
		EVLEPSC4245	692	42	45	1
		EVLEPSC4251	741	42	51	1
	Laminate Single Sided Middle Gallery Panel - Connector Ends - 48" High	EVLEPSC4827	527	48	27	1
		EVLEPSC4833	598	48	33	1
		EVLEPSC4839	669	48	39	1
		EVLEPSC4845	741	42	45	1
		EVLEPSC4851	839	42	51	1
	Laminate Single Sided Middle Gallery Panel - Connector Ends - 54" High	EVLEPSC5427	579	54	27	1
		EVLEPSC5433	662	54	33	1
		EVLEPSC5439	754	42	39	1
		EVLEPSC5445	882	54	45	1
		EVLEPSC5451	937	42	51	1

**EVLEPSCNC - LAMINATE SINGLE SIDED MIDDLE GALLERY PANEL, BELTLINE POWER, FINISHED ENDS**

- Attaches in middle of panel run with connector with “U” channel.
- To be installed in middle between two beltline panels in straight run.
- Cut out for electrics at beltline height.
- Finished in thermally fused laminate.
- No connection both sides.
- Laminate Gallery Panel height is inclusive of panel glides extended to their full height.
- If wood grain is selected, grain runs horizontally.
- End of run connector with “U” channel and bottom connecting brackets to be ordered separately.

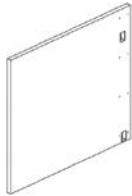
	DESCRIPTION	PRODUCT CODE	LIST PRICE	DIMENSIONS/INCHES		
			LP	H	W	D
	Laminate Single Sided Gallery Panel Finished Ends - 42” High	EVLEPSCB4227NC	482	42	27	1
		EVLEPSCB4233NC	538	42	33	1
		EVLEPSCB4239NC	604	42	39	1
		EVLEPSCB4245NC	741	42	45	1
		EVLEPSCB4251NC	741	42	51	1
	Laminate Single Sided Gallery Panel Finished Ends - 48” High	EVLEPSCB4827NC	527	48	27	1
		EVLEPSCB4833NC	598	48	33	1
		EVLEPSCB4839NC	669	48	39	1
		EVLEPSCB4845NC	741	48	45	1
		EVLEPSCB4851NC	839	48	51	1
	Laminate Single Sided Gallery Panel Finished Ends - 54” High	EVLEPSCB5427NC	579	54	27	1
		EVLEPSCB5433NC	662	54	33	1
		EVLEPSCB5439NC	754	54	39	1
		EVLEPSCB5445NC	882	54	45	1
		EVLEPSCB5451NC	937	54	51	1



**EVLEPSC - LAMINATE SINGLE SIDED MIDDLE GALLERY PANEL, BELTLINE POWER, CONNECTOR END**

- Attaches in middle of panel run with connector with “U” channel.
- To be installed in middle between two panels in straight run on one side.
- Finished in thermally fused laminate.
- Locking connection on one side.
- Laminate Gallery Panel height is inclusive of panel glides extended to their full height.
- If wood grain is selected, grain runs horizontally.
- End of run connector with “U” channel and bottom connecting brackets to be ordered separately.

	DESCRIPTION	PRODUCT CODE	LIST PRICE	DIMENSIONS/INCHES		
			LP	H	W	D
	Laminate Single Sided Middle Gallery Panel - Connector Ends - 42” High	EVLEPSCB4227	482	42	27	1
		EVLEPSCB4233	538	42	33	1
		EVLEPSCB4239	604	42	39	1
		EVLEPSCB4245	692	42	45	1
		EVLEPSCB4251	741	42	51	1
	Laminate Single Sided Middle Gallery Panel - Connector Ends - 48” High	EVLEPSCB4827	527	48	27	1
		EVLEPSCB4833	598	48	33	1
		EVLEPSCB4839	669	48	39	1
		EVLEPSCB4845	741	48	45	1
		EVLEPSCB4851	839	48	51	1
	Laminate Single Sided Middle Gallery Panel - Connector Ends - 54” High	EVLEPSCB5427	579	54	27	1
		EVLEPSCB5433	662	54	33	1
		EVLEPSCB5439	754	54	39	1
		EVLEPSCB5445	882	54	45	1
		EVLEPSCB5451	937	42	51	1







**EVLXPMNC - LAMINATE GALLERY EXTENSION PANEL, FINISHED END**

- Locking connection on one side, no connection at end.
- Finished in thermally fused laminate.
- Laminate Gallery Extension Panel height is inclusive of panel glides extended to their full height.
- If wood grain is selected, grain runs horizontally.
- Bottom connecting brackets to be ordered separately.

	DESCRIPTION	PRODUCT CODE	LIST PRICE LP	DIMENSIONS/INCHES		
				H	W	D
	Laminate Gallery Extension Panel	EVLXPML4224NC	395	42	24	1
	Finished End - 42" High	EVLXPML4230NC	482	42	30	1
		EVLXPML4236NC	538	42	36	1
		EVLXPML4242NC	603	42	42	1
		EVLXPML4248NC	691	42	48	1
	Laminate Gallery Extension Panel	EVLXPML4824NC	454	48	24	1
	Finished End - 48" High	EVLXPML4830NC	527	48	30	1
		EVLXPML4836NC	598	48	36	1
		EVLXPML4842NC	669	48	42	1
		EVLXPML4848NC	741	48	48	1
	Laminate Gallery Extension Panel	EVLXPML5424NC	807	54	24	1
	Finished End - 54" High	EVLXPML5430NC	579	54	30	1
		EVLXPML5436NC	662	54	36	1
		EVLXPML5442NC	754	54	42	1
		EVLXPML5448NC	882	54	48	1
	Laminate Gallery Extension Panel	EVLXPMR4224NC	395	42	24	1
	Finished End - 42" High	EVLXPMR4230NC	482	42	30	1
		EVLXPMR4236NC	538	42	36	1
		EVLXPMR4242NC	603	42	42	1
		EVLXPMR4248NC	691	42	48	1
	Laminate Gallery Extension Panel	EVLXPMR4824NC	454	48	24	1
	Finished End - 48" High	EVLXPMR4830NC	527	48	30	1
		EVLXPMR4836NC	598	48	36	1
		EVLXPMR4842NC	669	48	42	1
		EVLXPMR4848NC	741	48	48	1
	Laminate Gallery Extension Panel	EVLXPMR5424NC	495	54	24	1
	Finished End - 54" High	EVLXPMR5430NC	579	54	30	1
		EVLXPMR5436NC	662	54	36	1
		EVLXPMR5442NC	754	54	42	1
		EVLXPMR5448NC	882	54	48	1



**EVLXPM - LAMINATE GALLERY STRAIGHT EXTENSION PANEL, CONNECTOR ENDS**

- Locking connection both sides.
- Finished in thermally fused laminate.
- Laminate Gallery Panel height is inclusive of panel glides extended to their full height.
- If wood grain is selected, grain runs horizontally.
- Bottom connecting brackets to be ordered separately.

	DESCRIPTION	PRODUCT CODE	LIST PRICE LP	DIMENSIONS/INCHES		
				H	W	D
	Laminate Gallery Straight Extension	EVLXPML4224	741	42	24	1
	Panel - Connector Ends - Left - 42" High	EVLXPML4230	482	42	30	1
		EVLXPML4236	538	42	36	1
		EVLXPML4242	603	42	42	1
		EVLXPML4248	691	42	48	1
	Laminate Gallery Straight Extension	EVLXPML4824	454	48	24	1
	Panel - Connector Ends - Left - 48" High	EVLXPML4830	527	48	30	1
		EVLXPML4836	598	48	36	1
		EVLXPML4842	669	48	42	1
		EVLXPML4848	741	48	48	1
	Laminate Gallery Straight Extension	EVLXPML5424	495	54	24	1
	Panel - Connector Ends - Left - 54" High	EVLXPML5430	579	54	30	1
		EVLXPML5436	662	54	36	1
		EVLXPML5442	754	54	42	1
		EVLXPML5448	882	54	48	1
	Laminate Gallery Straight Extension	EVLXPMR4224	395	42	24	1
	Panel - Connector Ends - Right - 42" High	EVLXPMR4230	482	42	30	1
		EVLXPMR4236	538	42	36	1
		EVLXPMR4242	603	42	42	1
		EVLXPMR4248	691	42	48	1
	Laminate Gallery Straight Extension	EVLXPMR4824	454	48	24	1
	Panel - Connector Ends - Right - 48" High	EVLXPMR4830	527	48	30	1
		EVLXPMR4836	598	48	36	1
		EVLXPMR4842	669	48	42	1
		EVLXPMR4848	741	48	48	1
	Laminate Gallery Straight Extension	EVLXPMR5424	495	54	24	1
	Panel - Connector Ends - Right - 54" High	EVLXPMR5430	579	54	30	1
		EVLXPMR5436	662	54	36	1
		EVLXPMR5442	754	54	42	1
		EVLXPMR5448	882	54	48	1

**EV2LXP - LAMINATE GALLERY TWO-WAY EXTENSION PANEL, FINISHED ENDS**

- Panel connects at 90 degree with extension panel.
- Finished in thermally fused laminate.
- Laminate Gallery Extension Panel height is inclusive of panel glides extended to their full height.
- If wood grain is selected, grain runs horizontally.
- Corner connecting brackets to be ordered separately.

	DESCRIPTION	PRODUCT CODE	LIST PRICE LP	DIMENSIONS/INCHES		
				H	W	D
	Laminate Gallery Two-Way Extension Panel - Finished Ends - Left - 42" High	EV2LXPL4225	397	42	25	1
		EV2LXPL4231	482	42	31	1
		EV2LXPL4237	538	42	37	1
		EV2LXPL4243	604	42	43	1
		EV2LXPL4249	692	42	49	1
	Laminate Gallery Two-Way Extension Panel - Finished Ends - Left - 48" High	EV2LXPL4825	454	48	25	1
		EV2LXPL4831	527	48	31	1
		EV2LXPL4837	598	48	37	1
		EV2LXPL4843	669	48	43	1
		EV2LXPL4849	741	48	49	1
	Laminate Gallery Two-Way Extension Panel - Finished Ends - Left - 54" High	EV2LXPL5425	532	54	25	1
		EV2LXPL5431	608	54	31	1
		EV2LXPL5437	683	54	37	1
		EV2LXPL5443	831	54	43	1
		EV2LXPL5449	937	54	49	1
	Laminate Gallery Two-Way Extension Panel - Finished Ends - Right - 42" High	EV2LXPR4225	397	42	25	1
		EV2LXPR4231	482	42	33	1
		EV2LXPR4237	538	42	37	1
		EV2LXPR4243	604	42	43	1
		EV2LXPR4249	692	42	49	1
	Laminate Gallery Two-Way Extension Panel - Finished Ends - Right - 48" High	EV2LXPR4825	454	48	25	1
		EV2LXPR4831	527	48	33	1
		EV2LXPR4837	598	48	37	1
		EV2LXPR4843	669	48	43	1
		EV2LXPR4849	741	48	49	1
	Laminate Gallery Two-Way Extension Panel - Finished Ends - Right - 54" High	EV2LXPR5425	532	54	25	1
		EV2LXPR5431	608	54	31	1
		EV2LXPR5437	683	54	37	1
		EV2LXPR5443	831	54	43	1
		EV2LXPR5449	937	54	49	1

**EV3LXP - LAMINATE GALLERY THREE-WAY EXTENSION PANEL, FINISHED ENDS**

- Panel connects "T" configuration with extension panel.
- Finished in thermally fused laminate.
- Laminate Gallery Extension Panel height is inclusive of panel glides extended to their full height.
- If wood grain is selected, grain runs horizontally.
- Corner connecting brackets to be ordered separately.

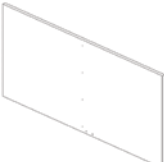
	DESCRIPTION	PRODUCT CODE	LIST PRICE LP	DIMENSIONS/INCHES		
				H	W	D
	Laminate Gallery Three-Way Extension Panel - Finished Ends - Left - 42" High	EV3LXPL4249	741	42	49	1
		EV3LXPL4261	882	42	61	1
		EV3LXPL4273	1027	42	73	1
	Laminate Gallery Three-Way Extension Panel - Finished Ends - Left - 48" High	EV3LXPL4849	839	48	49	1
		EV3LXPL4861	1031	48	61	1
		EV3LXPL4873	1224	48	73	1
	Laminate Gallery Three-Way Extension Panel - Finished Ends - Left - 54" High	EV3LXPL5449	937	54	49	1
		EV3LXPL5461	1224	54	61	1
		EV3LXPL5473	1415	54	73	1
	Laminate Gallery Three-Way Extension Panel - Finished Ends - Left - 42" High	EV3LXPR4249	741	42	49	1
		EV3LXPR4261	882	42	61	1
		EV3LXPR4273	1027	42	73	1
	Laminate Gallery Three-Way Extension Panel - Finished Ends - Left - 48" High	EV3LXPR4849	839	48	49	1
		EV3LXPR4861	1031	48	61	1
		EV3LXPR4873	1224	48	73	1
	Laminate Gallery Three-Way Extension Panel - Finished Ends - Left - 54" High	EV3LXPR5449	937	54	49	1
		EV3LXPR5461	1224	54	61	1
		EV3LXPR5473	1415	54	73	1

**EV4LXP - LAMINATE DOUBLE GALLERY PANEL FOR FOUR-WAY, FINISHED ENDS**

- Panel connects "+" configuration with extension panel.
- Finished in thermally fused laminate.
- Laminate Gallery Extension Panel height is inclusive of panel glides extended to their full height.
- If wood grain is selected, grain runs horizontally.
- Corner connecting brackets to be ordered separately

	DESCRIPTION	PRODUCT CODE	LIST PRICE LP	DIMENSIONS/INCHES		
				H	W	D
	Laminate Double Gallery Panel	EV4LXP4249	741	42	49	1
	Four-Way - Finished Ends - 42" High	EV4LXP4261	965	42	61	1
		EV4LXP4273	1188	42	73	1
	Laminate Double Gallery Panel	EV4LXP4849	807	48	49	1
	Four-Way - Finished Ends - 48" High	EV4LXP4861	1069	48	61	1
		EV4LXP4873	1299	48	73	1
	Laminate Double Gallery Panel	EV4LXP5449	937	54	49	1
	Four-Way - Finished Ends - 48" High	EV4LXP5461	1224	54	61	1
		EV4LXP5473	1415	54	73	1

**EV4LXPM - LAMINATE GALLERY EXTENSION PANEL FOR FOUR-WAY CONFIGURATION, FINISHED ENDS**

- Locking connection on one side only for four way panel.
- Finished in thermally fused laminate.
- Universal to be used on both sides of four way laminate panel.
- Laminate Gallery Extension Panel height is inclusive of panel glides extended to their full height.
- If wood grain is selected, grain runs horizontally.
- Bottom connecting brackets to be ordered separately.

	DESCRIPTION	PRODUCT CODE	LIST PRICE LP	DIMENSIONS/INCHES		
				H	W	D
	Laminate Gallery Extension Panel	EV4LXPM4224	395	42	24	1
	Four-Way - Finished Ends - 42" High	EV4LXPM4230	482	42	30	1
		EV4LXPM4236	538	42	36	1
		EV4LXPM4242	603	42	42	1
		EV4LXPM4248	691	42	58	1
	Laminate Gallery Extension Panel	EV4LXPM4824	454	48	24	1
	Four-Way - Finished Ends - 42" High	EV4LXPM4830	527	48	30	1
		EV4LXPM4836	598	48	36	1
		EV4LXPM4842	669	48	42	1
		EV4LXPM4848	741	48	48	1
	Laminate Gallery Extension Panel	EV4LXPM5424	495	54	24	1
	Four-Way - Finished Ends - 42" High	EV4LXPM5430	579	54	30	1
		EV4LXPM5436	662	54	36	1
		EV4LXPM5442	754	54	42	1
		EV4LXPM5448	882	54	48	1

**EVERCH - EVOLVE PANEL CONNECTOR WITH U CHANNEL**

- U channel attaches with screws to laminate end panel or laminate middle panel.
- Evolve panels attaches to connector.
- Pass thru at bottom and beltline location for power/data.
- U channel is welded to connector.
- Includes connector with U channel and hardware.

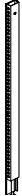
	DESCRIPTION	PRODUCT CODE	LIST PRICE	DIMENSIONS/INCHES		
			LP	H	W	D
	Panel Connector	EVERCH42	185	42	2.875	1
	U Channel	EVERCH48	198	48	2.875	1
		EVERCH54	214	54	2.875	1

**EVPBERCH - EVOLVE PANEL CONNECTOR WITH U CHANNEL FOR BELTLINE PANELS**

- U channel attaches with screws to laminate middle panel.
- Evolve panels attaches to connector.
- Pass thru at bottom and beltline location for power/data.
- U channel is welded to connector.
- Includes connector with U channel and hardware.

	DESCRIPTION	PRODUCT CODE	LIST PRICE	DIMENSIONS/INCHES		
			LP	H	W	D
	Panel Connector	EVPBERCH42	185	42	2.875	1
	U Channel	EVPBERCH48	198	48	2.875	1
		EVPBERCH54	214	54	2.875	1

**EVERCHNR - NO RACEWAY PANEL CONNECTOR WITH U CHANNEL**

- U channel attaches with screws to laminate end panel or laminate middle panel.
- Evolve NR panels attaches to connector.
- U channel is welded to NR connector.
- Includes NR connector with U channel and hardware.

	DESCRIPTION	PRODUCT CODE	LIST PRICE	DIMENSIONS/INCHES		
			LP	H	W	D
	No Raceway Connector with U Channel	EVERCH42NR	185	42	2.875	1
		EVERCH48NR	198	48	2.875	1
		EVERCH54NR	214	54	2.875	1

**EVPGDCP - GALLERY PANEL DATA POST / COMM LAY-IN**

- One way post attaches to Gallery Panel at the end to bring power and/or data cables from ceiling to Evolve panels.
- Accommodates up to 25 CAT 5 cables with electric. Accommodates up to 45 CAT 5 cables without electric.
- Middle Gallery panel with bottom cut out for electric must be ordered.
- Standard data post extension used above.
- Standard data post extension to be ordered separately.

	DESCRIPTION	PRODUCT CODE	LIST PRICE	DIMENSIONS/INCHES		
			LP	H	W	D
	Data Post	EVPGDCP42	247	42	3	
		EVPGDCP48	289	48	3	
		EVPGDCP54	316	54	3	

**EVHLPBB01 - LAMINATE GALLERY PANEL BOTTOM BRACKET**

- Laminate panel bottom bracket connects two laminate end panels at bottom with screws. • Bracket and screws included
- Available in standard paint colors.

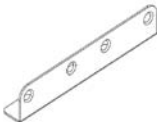
DESCRIPTION	PRODUCT CODE	LIST PRICE LP	DIMENSIONS/INCHES		
			H	W	D
 Bottom Bracket	EVHLPBB01	51	1.5	8	1

**EVHLPB01 - LAMINATE GALLERY PANEL CORNER BRACKET**

- Laminate panel corner bottom bracket connects two laminate panels at 90 degree. • Bracket and screws included.
- Available in standard paint colors.

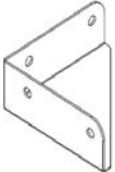
DESCRIPTION	PRODUCT CODE	LIST PRICE LP	DIMENSIONS/INCHES		
			H	W	D
 Corner Bracket	EVHLPB01	50	1.5	4	4

**EVPTTAU - EVOLVE CONNECTOR WITH U CHANNEL TOP TRIM ALUMINUM**

- Aluminum top trim longer by 0.625" to cover width of connector with U channel. • Available in standard paint colors.
- Trim can not span a post.

DESCRIPTION	PRODUCT CODE	LIST PRICE LP	DIMENSIONS/INCHES		
			H	W	D
 Top Trim Aluminum	EVPTTAU24	27	1	24.625	1
	EVPTTAU30	29	1	30.625	1
	EVPTTAU36	33	1	36.625	1
	EVPTTAU42	38	1	42.625	1
	EVPTTAU48	52	1	48.625	1
	EVPTTAU54	58	1	54.625	1
	EVPTTAU60	64	1	60.625	1
	EVPTTAU66	70	1	66.625	1
	EVPTTAU72	79	1	72.625	1
	EVPTTAU78	87	1	78.625	1
EVPTTAU84	93	1	84.625	1	

**EVLEP - 1" LAMINATE END PANEL**

- 1" Laminate End Panel attaches to an end of run connector.
- Left Hand or Right Hand available.
- Finished in thermally Fused Laminate.
- Includes threaded metal inserts and support brackets to attach a worksurface on one side.
- 1" Laminate end panel have panel leveling glides.
- If wood grain is selected, grain runs vertically.

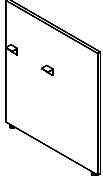
	DESCRIPTION	PRODUCT CODE	LIST PRICE LP	DIMENSIONS/INCHES		
				H	W	D
	1" Laminate End Panel - Right - 42" High	EVLEPR4224	403	42	24	1
		EVLEPR4230	503	42	30	1
		EVLEPR4236	603	42	36	1
		EVLEPR4242	702	42	42	1
		EVLEPR4248	803	42	48	1
	1" Laminate End Panel - Left - 42" High	EVLEPL4224	403	42	24	1
		EVLEPL4230	503	42	30	1
		EVLEPL4236	603	42	36	1
		EVLEPL4242	702	42	42	1
		EVLEPL4248	803	42	48	1
	1" Laminate End Panel - Right - 48" High	EVLEPR4824	454	48	24	1
		EVLEPR4830	575	48	30	1
		EVLEPR4836	690	48	36	1
		EVLEPR4842	800	48	42	1
		EVLEPR4848	917	48	48	1
	1" Laminate End Panel - Left - 48" High	EVLEPL4824	454	48	24	1
		EVLEPL4830	575	48	30	1
		EVLEPL4836	690	48	36	1
		EVLEPL4842	800	48	42	1
		EVLEPL4848	917	48	48	1

**EVLMP - 1" LAMINATE MIDDLE PANEL**

- 1" Laminate Middle Panel attaches to a double inline connector.
- Finished in thermally Fused Laminate.
- Includes threaded metal inserts and support brackets to attach worksurfaces on both sides.
- 1" Laminate middle panel has panel leveling glides.
- If wood grain is selected, grain runs vertically.

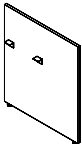
	DESCRIPTION	PRODUCT CODE	LIST PRICE LP	DIMENSIONS/INCHES		
				H	W	D
	1" Laminate Middle Panel - 42" High	EVLMP4224	450	42	24	1
		EVLMP4230	547	42	30	1
		EVLMP4236	648	42	36	1
		EVLMP4242	753	42	42	1
		EVLMP4248	905	42	48	1
	1" Laminate Middle Panel - 48" High	EVLMP4824	502	48	24	1
		EVLMP4830	619	48	30	1
		EVLMP4836	733	48	36	1
		EVLMP4842	850	48	42	1
		EVLMP4848	965	48	48	1

**EVLEPXXYYA - 1" LAMINATE END PANEL WITH ACCESSORY RAIL**

- 1" Laminate End Panel attaches to an end of run connector.
- Includes accessory rail.
- Accessories can be used on accessory rail. Please see accessory section for additional details.
- Finished in thermally Fused Laminate.
- Includes threaded metal inserts and support brackets to attach a worksurface on one side.
- 1" Laminate end panel have panel leveling glides.
- If wood grain is selected, grain runs vertically.

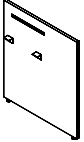
	DESCRIPTION	PRODUCT CODE	LIST PRICE	DIMENSIONS/INCHES		
			LP	H	W	D
	1" Laminate End Panel with Accessory Rail - Right - 42" High	EVLEPR4224A	455	42	24	1
		EVLEPR4230A	554	42	30	1
		EVLEPR4236A	656	42	36	1
		EVLEPR4242A	760	42	42	1
		EVLEPR4248A	865	42	48	1
	1" Laminate End Panel with Accessory Rail - Left - 42" High	EVLEPL4224A	455	42	24	1
		EVLEPL4230A	554	42	30	1
		EVLEPL4236A	656	42	36	1
		EVLEPL4242A	760	42	42	1
		EVLEPL4248A	865	42	48	1
1" Laminate End Panel with Accessory Rail - Right - 48" High	EVLEPR4824A	510	48	24	1	
	EVLEPR4830A	617	48	30	1	
	EVLEPR4836A	695	48	36	1	
	EVLEPR4842A	797	48	42	1	
	EVLEPR4848A	974	48	48	1	
1" Laminate End Panel with Accessory Rail - Left - 48" High	EVLEPL4824A	510	48	24	1	
	EVLEPL4830A	617	48	30	1	
	EVLEPL4836A	695	48	36	1	
	EVLEPL4842A	797	48	42	1	
	EVLEPL4848A	974	48	48	1	

**EVLMPXXYYA - 1" LAMINATE MIDDLE PANEL WITH ACCESSORY RAIL**

- 1" Laminate Middle Panel attaches to a double inline connector.
- Includes accessory rail.
- Accessories can be used on accessory rail. Please see accessory section for additional details.
- Finished in thermally Fused Laminate.
- Includes threaded metal inserts and support brackets to attach a worksurface on one side.
- 1" Laminate middle panel has panel leveling glides.
- If wood grain is selected, grain runs vertically.

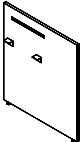
	DESCRIPTION	PRODUCT CODE	LIST PRICE	DIMENSIONS/INCHES		
			LP	H	W	D
	1" Laminate Middle Panel with Accessory Rail - 42" High	EVLMP4224A	513	42	24	1
		EVLMP4230A	615	42	30	1
		EVLMP4236A	722	42	36	1
		EVLMP4242A	820	42	42	1
		EVLMP4248A	926	42	48	1
	1" Laminate Middle Panel with Accessory Rail - 48" High	EVLMP4824A	565	48	24	1
		EVLMP4830A	690	48	30	1
		EVLMP4836A	800	48	36	1
		EVLMP4842A	917	48	42	1
		EVLMP4848A	1033	48	48	1

**EVPDIC - DOUBLE INLINE PANEL CONNECTOR**

- Used to connect 1" laminate middle panel to panels of equal height in a straight run.
- Aluminum top trim for double inline connector must be used.
- Provides slotted support for worksurfaces and hardware support.
- Includes two slotted posts with leveling glides and connection hardware.
- Use 17" flexible mesh jumper cable to pass-through panels.

DESCRIPTION	PRODUCT CODE	LIST PRICE	DIMENSIONS/INCHES		
			H	W	D
Double Inline Panel Connector	EVPDIC42	180	42	2	
	EVPDIC48	191	48	2	

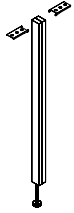

**EVPBIC - BELTLINE DOUBLE INLINE PANEL CONNECTOR**

- Used to connect 1" laminate middle panel to panels of equal height in a straight run.
- Use in-between beltline panels.
- Aluminum top trim for double inline connector must be used.
- Provides slotted support for worksurfaces and hardware support.
- Includes two slotted posts with leveling glides and connection hardware.
- Use 17" flexible mesh jumper cable to pass-through panels.

DESCRIPTION	PRODUCT CODE	LIST PRICE	DIMENSIONS/INCHES		
			H	W	D
Beltline Double Inline Panel Connector	EVPBIC42	180	42	2	
	EVPBIC48	191	48	2	

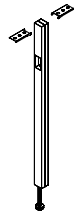

**EVDPVTF - DOUBLE INLINE CONNECTOR TRIM**

- Attaches to exposed side of double inline connector.

	DESCRIPTION	PRODUCT CODE	LIST PRICE	DIMENSIONS/INCHES		
				H	W	D
	Double Inline Connector Trim	EVDPVTF42	23	42		
		EVDPVTF48	29	48		

**EVPTTA - DOUBLE INLINE PANEL CONNECTOR TOP TRIM - ALUMINUM**

- Aluminum top trim is longer by 1.125" to cover width of panel and double inline connector.
- Trim cannot span a post connector.
- Available in standard and premium paint colors.

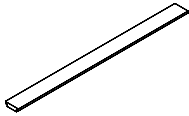
	DESCRIPTION	PRODUCT CODE	LIST PRICE	DIMENSIONS/INCHES		
				H	W	D
	Double Inline Connector Trim - Aluminum	EVPTTA25	27		25	
		EVPTTA31	29		31	
		EVPTTA37	23		37	
		EVPTTA43	38		43	
		EVPTTA49	52		49	
		EVPTTA55	58		55	
		EVPTTA61	64		61	
		EVPTTA67	70		67	
		EVPTTA73	79		73	
		EVPTTA79	87		79	
	EVPTTA85	93		83		

**EVPSD - DOOR PANEL - SOLID**

- All door surfaces are high pressure laminate.
- HP Laminate finish available in all standard Evolve colors.
- Two panel widths: 36" or 42" High.
- 84" Door Panel height = 66"H panel plus one 18"H Panel Extension Module.
- 90" Door Panel height = 66" H panel plus one 24"H or two 12"H Panel Extension Modules.
- Door and door trim can be specified left- or right-handed (see diagram).
- Handedness of Door Panel can be changed in the field.
- Select door frame color from standard trim colors.
- Door Sizes:
  - 36"W Door is 33.63"W without frame (This door is not ADA compliant)
  - 42"W Door is 39.63"W without frame
  - 84"H Door is 81.5"H without frame
  - 90"H Door is 87.5"H without frame
- If laminate is selected in a wood grain, the grain runs vertical.
- Customer is responsible to confirm and meet all city, county or any other municipality codes in relation to door clearances.
- Knob or lever to be ordered separately

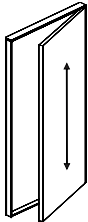
	DESCRIPTION	PRODUCT CODE	LIST PRICE HPL	DIMENSIONS/INCHES		
				H	W	D
	Door Panel - Solid - 84" High x 36" Wide	EVPSD8436L	3060	84	36	2 7/8
		EVPSD8436R	3060	84	36	2 7/8
	Door Panel - Solid - 84" High x 42" Wide	EVPSD8442L	3541	84	42	2 7/8
		EVPSD8442R	3541	84	42	2 7/8
	Door Panel - Solid - 90" High x 36" Wide	EVPSD9036L	3060	90	36	2 7/8
		EVPSD9036R	3060	90	36	2 7/8
	Door Panel - Solid - 90" High x 42" Wide	EVPSD9042L	3541	90	42	2 7/8
		EVPSD9042R	3541	90	42	2 7/8

**EVPDG- FULL GLAZED DOOR PANEL**

- All door surfaces are high pressure laminate with window.
- HP laminate finish available in all standard Evolve colors.
- Two panels width 36" or 42"
- 84" Door panel height = 66"H panel and 18" H Panel Extension Modules.
- 90" Door panel height = 66"H panel and 24" H or two 12" H Panel extension modules.
- Door and door trim can be specified left or right handed (see diagram).
- Handedness of Door can be changed in field.
- Select frame color from standard trim colors.
- Door Sizes:
  - 36"W Door is 33.63"W without frame (This door is not ADA compliant)
  - 42"W Door is 39.63"W without frame
  - 84"H Door is 81.5"H without frame
  - 90"H Door is 87.5"H without frame
- If laminate is selected in wood grain, the grain runs vertical.
- Customer is responsible to confirm and meet, city, county or any other municipality codes in relation to door clearances
- Knob or lever to be ordered separately

	DESCRIPTION	PRODUCT CODE	PRICE		DIMENSIONS/INCHES		
			CLR	FRST ADD	H	W	D
	Door Panel - Glazed - 84" High x 36" Wide	EVPDG8436L EVPDG8436R	3437 3437	137 137	84 84	36 36	2 7/8 2 7/8
	Door Panel - Glazed - 84" High x 42" Wide	EVPDG8442L EVPDG8442R	3918 3918	139 139	84 84	42 42	2 7/8 2 7/8
	Door Panel - Glazed - 90" High x 36" Wide	EVPDG9036L EVPDG9036R	3437 3437	137 137	90 90	36 36	2 7/8 2 7/8
	Door Panel - Glazed - 90" High x 42" Wide	EVPDG9042L EVPDG9042R	3918 3918	139 139	90 90	42 42	2 7/8 2 7/8

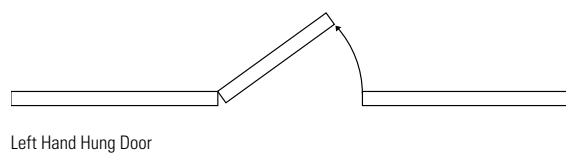
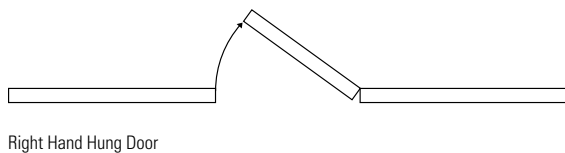

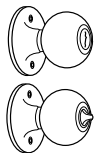
	Knob Lock Set (Knob Lock Set is not ADA compliant) Lock set sold separately from doors. Specific core #'s and Master Key not available	EVPDSL01	128				
---	---	----------	-----	--	--	--	--

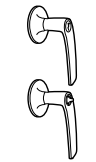
	Lever Lock Set Lock set sold separately from doors. Specific core #'s and Master Key not available	EVPDSL02	175				
---	--	----------	-----	--	--	--	--

**EVHLPF01 - LOW PROFILE FOOT**

- Used to provide additional support to panel run without adding panels
- Connects to inline connector or end of run at base of panels

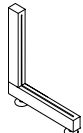
	DESCRIPTION	PRODUCT CODE	LIST PRICE	DIMENSIONS/INCHES		
				H	W	D
	Low Profile Foot	EVHLPF01	139	11	1	11

**EVPDPS - EVOLVE SLIDING DOOR**

- Sliding door provides privacy in an open plan environment.
- Complete sliding door kit includes aluminum door panel, rails, and capture extrusion.
- Door is non-handed (Can be assembled to slide left or right).
- 36" wide door spans 36" opening. Sliding door rails must be installed on adjacent 42" panel.
- 42" wide door spans 42" opening. Sliding door rails must be installed on adjacent 48" panel.
- Available in Clear (CLR) or Frosted (FRST) acrylic glazing.
- Available in all Panel Frame Finishes.
- Metal Finish - standard panel frame finishes.
- Lockable - key option - key alike, W series or random

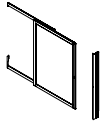
DESCRIPTION	PRODUCT CODE	LIST PRICE	DIMENSIONS/INCHES		
			H	W	D
 Sliding Door	EVPDPS6636	2799	66	43	3
	EVPDPS6642	2938	66	49	3
	EVPDPS8436	3032	84	36	3
	EVPDPS8442	3170	84	42	3
	EVPDPS9036	3107	90	36	3
	EVPDPS9042	3246	90	42	3

**EVPDPSF - EVOLVE SLIDING DOOR**

- Sliding Door provides privacy in an open plan environment.
- Complete Sliding Door kit includes aluminum door panel, rails, and capture extrusion.
- Door is non-handed (Can be assembled to slide left or right).
- 36" wide door spans 36" opening. Sliding Door rails must be installed on adjacent 42" panel.
- 42" wide door spans 42" opening. Sliding Door rails must be installed on adjacent 48" panel.
- Available in standard felt finishes.
- Available in all Panel Frame Finishes.
- Felt Finish - Standard
- Metal Finish - standard panel frame finishes.
- Lockable - key option - key alike, W series or random

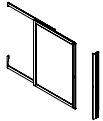
DESCRIPTION	PRODUCT CODE	LIST PRICE	DIMENSIONS/INCHES		
			H	W	D
 Sliding Door	EVPDPSF6636	2026	66	43	3
	EVPDPSF6642	2126	66	49	3
	EVPDPSF8436	2233	84	43	3
	EVPDPSF8442	2359	84	49	3
	EVPDPSF9036	2258	90	43	3
	EVPDPSF9042	2359	90	49	3

**EVPSLOCK - SLIDING DOOR LOCK**

- Lock bracket attaches to sliding door with screws.
- Includes strike plate bracket which attaches to slots in connector.
- Lock included.
- Lock sets sold separately from sliding doors.
- Available in Tungsten only.

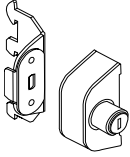
	DESCRIPTION	PRODUCT CODE	LIST PRICE	DIMENSIONS/INCHES		
				H	W	D
	Sliding Door Lock - Right	EVPSLOCKR	316	2.65	1.2	0.9
	Sliding Door Lock - Left	EVPSLOCKL	316	2.65	1.2	0.9

**EVMPK02 - MINI PANEL KIT**

- Evolve's Mini Panel Kits are available to our dealers and their sales staff.
- All Mini Panel Kit orders receive standard freight terms (Free freight applies to orders dock delivered to one commercial business location in the contiguous United States during normal business hours. Residential deliveries will incur additional delivery charges.)
- The Evolve mini panel is an excellent sales tool featuring a cut away of a module and samples of various hardware and electrical components and consists of the following:
  - 1 EVFP3024 30 x 24 Premium with cut-away
  - 1 EVPCP232 Two-way corner post
  - 1 EVPER30 End of run trim kit
  - 1 EVDHPT24 High Profile Top Cap
  - 1 EVDCPHP2 Two-way High Profile Top Cap
  - 1 EVDPE4 Post Extension Lay in
  - 1 EVE8PD24 Power distribution housing
  - 1 EVE8CP16 Jumper Cable
  - 1 EVE8RDA/B Duplex Receptacle
  - 1 Pizza cutter spline tool
  - 1 Replacement fabric
  - 1 Panel Bag with Evolve Logo
  - 1 Parts Bag with Evolve Logo

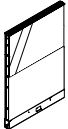
	DESCRIPTION	PRODUCT CODE	LIST PRICE	DIMENSIONS/INCHES		
				H	W	D
	Mini Panel Kit	EVMPK02	2945	30	24	2 7/8

**EVPRGLAXYY - ACOUSTIC GRID 5FT WIDE**

- PET acoustic grid installed on top of panels
- Acoustic grid kit includes PET pieces, aluminum channel, hardware
- Panels configuration in back 30-30 , aluminum channel runs depth wise
- PET slats run from side to side
- PET pieces available in standard PET colors
- Separate PET colors available for outer skirt and inner structure
- Top trim with channel to be ordered separately
- Shipped KD , to be assembled on job site
- Additional sizes available up to 10' x 12'

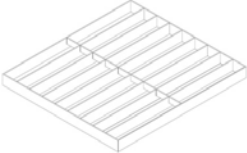
DESCRIPTION	PRODUCT CODE	LIST PRICE	DIMENSIONS/INCHES		
			H	W	D
	EVPRGLA4860D	2731	5.5	60	48
	EVPRGLA6060D	3236	5.5	60	60
	EVPRGLA7260D	3741	5.5	60	72
	EVPRGLA8460D	4246	5.5	60	84
	EVPRGLA9060D	4499	5.5	60	90
	EVPRGLA9660D	4789	5.5	60	96

**EVPRGLAXYY - ACOUSTIC GRID 6FT WIDE**

- PET acoustic grid installed on top of panels
- Acoustic grid kit includes PET pieces, aluminum channel, hardware
- Panels configuration in back 24-24-24 , aluminum channel runs depth wise
- PET slats run from side to side
- PET pieces available in standard PET colors
- Separate PET colors available for outer skirt and inner structure
- Top trim with channel to be ordered separately
- Shipped KD , to be assembled on job site
- Additional sizes available up to 10' x 12'

DESCRIPTION	PRODUCT CODE	LIST PRICE	DIMENSIONS/INCHES		
			H	W	D
	EVPRGLA4872D	3283	5.5	72	48
	EVPRGLA6072D	3896	5.5	72	60
	EVPRGLA7272D	4507	5.5	72	72
	EVPRGLA8472D	5118	5.5	72	84
	EVPRGLA9072D	5422	5.5	72	90
	EVPRGLA9672D	5766	5.5	72	96

**EVPRGLAXYY - ACOUSTIC GRID 6-1/2FT WIDE**

- PET acoustic grid installed on top of panels
- Acoustic grid kit includes PET pieces, aluminum channel, hardware
- Panels configuration in back 24-30-24 , aluminum channel runs depth wise
- PET slats run from side to side
- PET pieces available in standard PET colors
- Separate PET colors available for outer skirt and inner structure
- Top trim with channel to be ordered separately
- Shipped KD , to be assembled on job site
- Additional sizes available up to 10' x 12'

DESCRIPTION	PRODUCT CODE	LIST PRICE	DIMENSIONS/INCHES		
			H	W	D
	EVPRGLA4878	3249	6.5	78	48
	EVPRGLA6078	3851	6.5	78	60
	EVPRGLA7278	4407	6.5	78	72
	EVPRGLA8478	5053	6.5	78	84
	EVPRGLA9078	5353	6.5	78	90
	EVPRGLA9678	5689	6.5	78	96

**EVPRGLAXXY - ACOUSTIC GRID 7FT WIDE**

- PET acoustic grid installed on top of panels
- Acoustic grid kit includes PET pieces, aluminum channel, hardware
- Panels configuration in back 24-36-24 , aluminum channel runs depth wise
- PET slats run from side to side
- PET pieces available in standard PET colors
- Separate PET colors available for outer skirt and inner structure
- Top trim with channel to be ordered separately
- Shipped KD, to be assembled on job site
- Additional sizes available up to 10' x 12'

DESCRIPTION	PRODUCT CODE	LIST PRICE	DIMENSIONS/INCHES		
			H	W	D
	EVPRGLA4884D	3671	5.5	84	48
	EVPRGLA6084D	4346	5.5	84	60
	EVPRGLA7284D	5021	5.5	84	72
	EVPRGLA8484D	5696	5.5	84	84
	EVPRGLA9084D	6034	5.5	84	90
	EVPRGLA9684D	6409	5.5	84	96

**EVPRGLAXXY - ACOUSTIC GRID 7-1/2 FT WIDE**

- PET acoustic grid installed on top of panels
- Acoustic grid kit includes PET pieces, aluminum channel, hardware
- Panels configuration in back 30-30-30 , aluminum channel runs depth wise
- PET slats run from side to side
- PET pieces available in standard PET colors
- Separate PET colors available for outer skirt and inner structure
- Top trim with channel to be ordered separately
- Shipped KD, to be assembled on job site
- Additional sizes available up to 10' x 12'

DESCRIPTION	PRODUCT CODE	LIST PRICE	DIMENSIONS/INCHES		
			H	W	D
	EVPRGLA4890D	3812	5.5	90	48
	EVPRGLA6090D	4518	5.5	90	60
	EVPRGLA7290D	5225	5.5	90	72
	EVPRGLA8490D	5933	5.5	90	84
	EVPRGLA9090D	6288	5.5	90	90
	EVPRGLA9690D	6678	5.5	90	96

**EVPRGLAXXY - ACOUSTIC GRID 8FT WIDE**

- PET acoustic grid installed on top of panels
- Acoustic grid kit includes PET pieces, aluminum channel, hardware
- Panels configuration in back 30-36-30 , aluminum channel runs depth wise
- PET slats run from side to side
- PET pieces available in standard PET colors
- Separate PET colors available for outer skirt and inner structure
- Top trim with channel to be ordered separately
- Shipped KD, to be assembled on job site
- Additional sizes available up to 10' x 12'

DESCRIPTION	PRODUCT CODE	LIST PRICE	DIMENSIONS/INCHES		
			H	W	D
	EVPRGLA4896D	4094	5.5	96	48
	EVPRGLA6096D	4834	5.5	96	60
	EVPRGLA7296D	5572	5.5	96	72
	EVPRGLA8496D	6312	5.5	96	84
	EVPRGLA9096D	6684	5.5	96	90
	EVPRGLA9696D	7089	5.5	96	96

**EVPRGLAXYY - ACOUSTIC GRID 12FT WIDE**

- PET acoustic grid installed on top of panels
- Acoustic grid kit includes PET pieces, aluminum channel, hardware
- Panels configuration in back 24-30--36-30-24 , aluminum channel runs depth wise
- PET slats run from side to side
- PET pieces available in standard PET colors
- Top trim with channel to be ordered separately
- Beam kit above opening for acoustic grid to be ordered separately
- Shipped KD, to be assembled on job site

DESCRIPTION	PRODUCT CODE	LIST PRICE	DIMENSIONS/INCHES		
			H	W	D
	EVPRGLA120144D	9422	5.5	144	120



**EVPTTCA - ALUMINUM TOP TRIM WITH CHANNEL**

- Top trim with channel
- Available in standard paint colors
- Note: Trim can span inline connector, but not a Post

DESCRIPTION	PRODUCT CODE	LIST PRICE	DIMENSIONS/INCHES		
			H	W	D
	EVPTTCA18	20		18	2.875
	EVPTTCA24	28		24	2.875
	EVPTTCA30	36		30	2.875
	EVPTTCA36	39		36	2.875
	EVPTTCA42	47		42	2.875
	EVPTTCA48	57		48	2.875
	EVPTTCA54	67		54	2.875
	EVPTTCA60	74		60	2.875
	EVPTTCA66	81		66	2.875
	EVPTTCA72	90		72	2.875
	EVPTTCA78	98		78	2.875
	EVPTTCA84	109		84	2.875
	EVPTTCA90	115		90	2.875
	EVPTTCA96	125		96	2.875





When ordering Panel Extension Modules, Inline Panel Extension Connectors (EVPIEC) must be ordered separately. Please see EVPIEC for details.

Inline Panel Extension Connectors connect two panel extension modules of equal height in a straight run.

Extension connectors do **not** provide support for hang-on storage components above 66" H.

When specifying stacking panels up to 66" H and using a single full height connector additional single clamps (EVCLVAR) are recommended. Order 2 clamps per extension module.

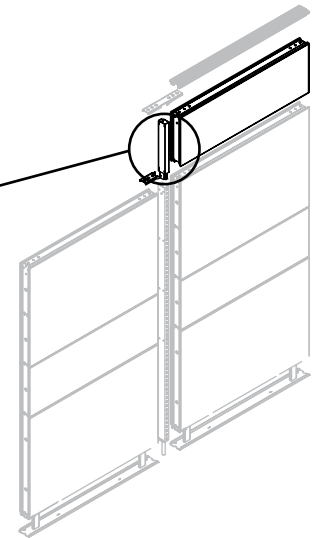
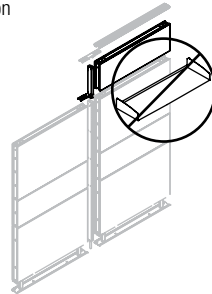

EXTENSION MODULES BY TYPE

Fabric Panel Extension Module

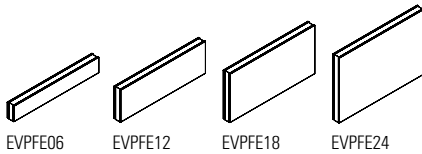

Fabric Panel Extension Module - Premium

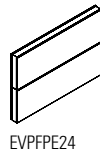

Tempered Glass Panel Extension Module

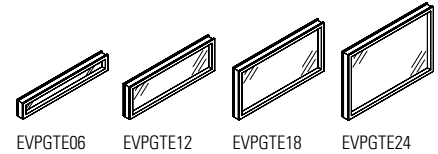

Tempered Glass Panel Extension Module - Premium

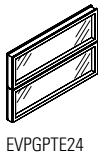

Write Board Extension Module - Single Sided

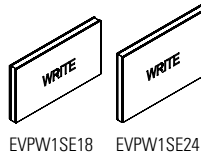

Write Board Extension Module - Double Sided

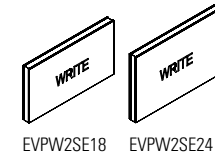

Laminate Extension Module - Single Sided

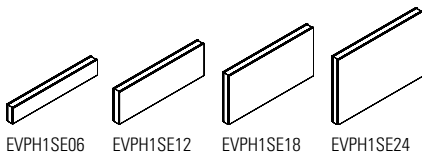

Laminate Extension Module - Double Sided

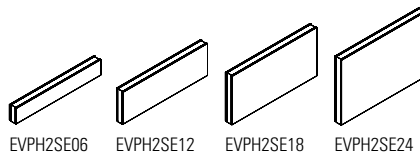

Air Flow Extension Module

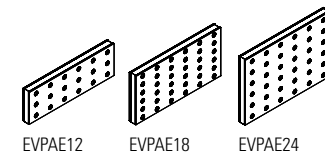

Open Panel Extension Module

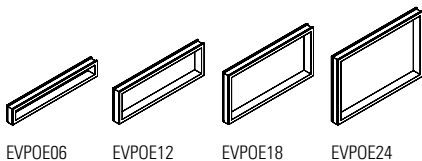

Panel Mount Privacy Glass

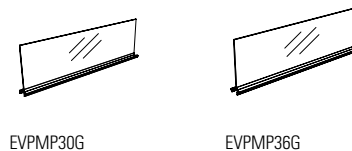

Panel Mount PET Felt Divider

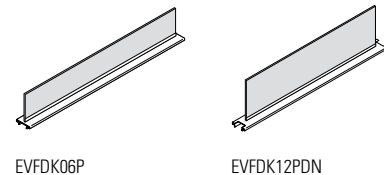

**EVPFE - FABRIC PANEL EXTENSION MODULE**

- Attaches on top of a panel.
- Modules can be stacked to add privacy or divide space.
- Panel Extension Modules are not load bearing if installed higher than 66" High.
- Each side of the fabric module may have a different fabric within the same grade at no charge.
- If different grades of fabric are used on one module, the entire module must be priced at highest grade.
- When ordering Panel Extension Modules, additional connectors are required.
- \*Top Trims are not included with Extension Modules.

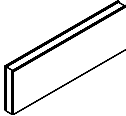
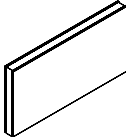
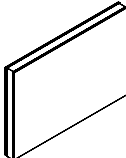
	DESCRIPTION	PRODUCT CODE	LIST PRICE		DIMENSIONS/INCHES		
			Gr1	Gr2	H	W	D
	Fabric Panel Extension Module - 6" High	EVPFE0618	198	208	6	18	2 7/8
		EVPFE0624	201	215	6	24	2 7/8
		EVPFE0630	220	240	6	30	2 7/8
		EVPFE0636	244	265	6	36	2 7/8
		EVPFE0642	277	295	6	42	2 7/8
		EVPFE0648	297	320	6	48	2 7/8
		EVPFE0654	320	346	6	54	2 7/8
		EVPFE0660	344	373	6	60	2 7/8
	Fabric Panel Extension Module - 12" High	EVPFE1218	198	208	12	18	2 7/8
		EVPFE1224	201	215	12	24	2 7/8
		EVPFE1230	220	240	12	30	2 7/8
		EVPFE1236	244	265	12	36	2 7/8
		EVPFE1242	277	295	12	42	2 7/8
		EVPFE1248	297	320	12	48	2 7/8
		EVPFE1254	320	346	12	54	2 7/8
		EVPFE1260	344	373	12	60	2 7/8
	Fabric Panel Extension Module - 18" High	EVPFE1818	239	257	18	18	2 7/8
		EVPFE1824	248	274	18	24	2 7/8
		EVPFE1830	269	298	18	30	2 7/8
		EVPFE1836	312	342	18	36	2 7/8
		EVPFE1842	342	380	18	42	2 7/8
		EVPFE1848	374	413	18	48	2 7/8
		EVPFE1854	405	449	18	54	2 7/8
		EVPFE1860	440	488	18	60	2 7/8
	Fabric Panel Extension Module - 24" High	EVPFE2418	239	257	24	18	2 7/8
		EVPFE2424	248	274	24	24	2 7/8
		EVPFE2430	269	298	24	30	2 7/8
		EVPFE2436	312	342	24	36	2 7/8
		EVPFE2442	342	380	24	42	2 7/8
		EVPFE2448	374	413	24	48	2 7/8
		EVPFE2454	405	449	24	54	2 7/8
		EVPFE2460	440	488	24	60	2 7/8

**EVPFPE - FABRIC PANEL EXTENSION MODULE - PREMIUM**

- Attaches on top of a panel.
- Modules can be stacked to add privacy or to divide space.
- Panel Extension Modules are not load bearing above 66" High.
- Each side of each module may have a different fabric within the same grade at no charge.
- If different grades of fabric are used on the Panel Extension Module, the module must be priced at highest grade.
- When ordering Panel Extension Modules, additional connectors are required.
- \*Top Trims are not included with Extension Modules.

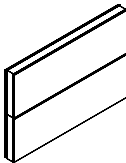
	DESCRIPTION	PRODUCT CODE	LIST PRICE		DIMENSIONS/INCHES		
			Gr1	Gr2	H	W	D
	Fabric Panel Extension Module - Premium - 24" High	EVPFPE2418	323	343	24	18	2 7/8
		EVPFPE2424	344	371	24	24	2 7/8
		EVPFPE2430	386	414	24	30	2 7/8
		EVPFPE2436	434	464	24	36	2 7/8
		EVPFPE2442	487	525	24	42	2 7/8
		EVPFPE2448	523	562	24	48	2 7/8
		EVPFPE2454	577	621	24	54	2 7/8
		EVPFPE2460	630	680	24	60	2 7/8

**EVPGTE - TEMPERED GLASS PANEL EXTENSION MODULE**

- Attaches on top of panel.
- Modules can be stacked to add privacy or to divide space.
- Panel Extension Modules are not load bearing above 66" H.
- Standard in clear (CLR) glass.
- Frosted Glass (FRST) 40% upcharge. Contact EVOLVE Customer Support for details.
- When ordering Panel Extension Modules, additional connectors are required.
- \*Top Trims are not included with Extension Modules.

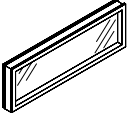
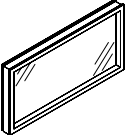
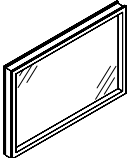
	DESCRIPTION	PRODUCT CODE	LIST PRICE	DIMENSIONS/INCHES		
				H	W	D
	Tempered Glass Panel Extension Module - 6" High	EVPGTE0618	380	6	18	2 7/8
		EVPGTE0624	410	6	24	2 7/8
		EVPGTE0630	492	6	30	2 7/8
		EVPGTE0636	515	6	36	2 7/8
		EVPGTE0642	630	6	42	2 7/8
		EVPGTE0648	702	6	48	2 7/8
		EVPGTE0654	768	6	54	2 7/8
EVPGTE0660	828	6	60	2 7/8		
	Tempered Glass Panel Extension Module - 12" High	EVPGTE1218	380	12	18	2 7/8
		EVPGTE1224	410	12	24	2 7/8
		EVPGTE1230	492	12	30	2 7/8
		EVPGTE1236	515	12	36	2 7/8
		EVPGTE1242	630	12	42	2 7/8
		EVPGTE1248	702	12	48	2 7/8
		EVPGTE1254	768	12	54	2 7/8
EVPGTE1260	828	12	60	2 7/8		
	Tempered Glass Panel Extension Module - 18" High	EVPGTE1818	571	18	18	2 7/8
		EVPGTE1824	587	18	24	2 7/8
		EVPGTE1830	629	18	30	2 7/8
		EVPGTE1836	686	18	36	2 7/8
		EVPGTE1842	777	18	42	2 7/8
		EVPGTE1848	870	18	48	2 7/8
		EVPGTE1854	944	18	54	2 7/8
EVPGTE1860	1013	18	60	2 7/8		
	Tempered Glass Panel Extension Module - 24" High	EVPGTE2418	571	24	18	2 7/8
		EVPGTE2424	587	24	24	2 7/8
		EVPGTE2430	629	24	30	2 7/8
		EVPGTE2436	686	24	36	2 7/8
		EVPGTE2442	777	24	42	2 7/8
		EVPGTE2448	870	24	48	2 7/8
		EVPGTE2454	944	24	54	2 7/8
EVPGTE2460	1013	24	60	2 7/8		

**EVPGPTE - TEMPERED GLASS PREMIUM PANEL EXTENSION MODULE**

- Attaches to top of a panel.
- Modules can be stacked to add privacy or to divide space.
- Panel Extension Modules are not load bearing above 66" H.
- Standard in clear (CLR) glass.
- Frosted Glass (FRST) 40% upcharge. Contact EVOLVE Customer Support for details.
- When ordering Panel Extension Modules, additional connectors are required.
- \*Top Trims are not included with Extension Modules.

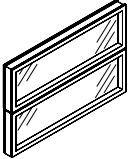
	DESCRIPTION	PRODUCT CODE	LIST PRICE	DIMENSIONS/INCHES		
				H	W	D
	Tempered Glass Premium Panel Extension Module - 24" High	EVPGPTE2418	562	24	18	2 7/8
		EVPGPTE2424	623	24	24	2 7/8
		EVPGPTE2430	712	24	30	2 7/8
		EVPGPTE2436	810	24	36	2 7/8
		EVPGPTE2442	898	24	42	2 7/8
		EVPGPTE2448	1007	24	48	2 7/8
		EVPGPTE2454	1098	24	54	2 7/8
EVPGPTE2460	1189	224	60	2 7/8		

**EVPSG - PASS THRU SLIDING GLASS EXTENSION MODULE**

- Pass thru with sliding glass door module.
- Attaches on top of a panel.
- Module can be stacked to add privacy or divide space.
- Panel extension module is not load bearing if installed higher than 66" High.
- When ordering panel extension modules , additional connectors are required.
- \*Top Trims are not included with Extension Modules.

	DESCRIPTION	PRODUCT CODE	PRICE		DIMENSIONS/INCHES		
			CLR	FRS ADD	H	W	D
	Reception Panel Extension Module - 6" High	EVPSGE0636	411	86	6	36	2 7/8
		EVPSGE0642	440	93	6	42	2 7/8
		EVPSGE0648	535	109	6	48	2 7/8

**EVPSG - PASS THRU SLIDING GLASS EXTENSION MODULE**

- Pass thru with sliding glass door module.
- Attaches on top of a panel.
- Module can be stacked to add privacy or divide space.
- Panel extension module is not load bearing if installed higher than 66" High.
- When ordering panel extension modules , additional connectors are required.
- \*Top Trims are not included with Extension Modules.

	DESCRIPTION	PRODUCT CODE	PRICE		DIMENSIONS/INCHES		
			CLR	FRS ADD	H	W	D
	Reception Panel Extension Module - 12" High	EVPSGE1236	498	102	12	36	2 7/8
		EVPSGE1242	527	109	12	42	2 7/8
		EVPSGE1248	552	115	12	48	2 7/8

**EVPSGX - TALK THRU GLASS EXTENSION MODULE**

- Talk thru glass module.
- Attaches on top of a panel.
- Module can be stacked to add privacy or divide space.
- Panel extension module is not load bearing if installed higher than 66" High.
- When ordering panel extension modules , additional connectors are required.
- \*Top Trims are not included with Extension Modules.

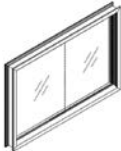
	DESCRIPTION	PRODUCT CODE	PRICE		DIMENSIONS/INCHES		
			CLR	FRS ADD	H	W	D
	Reception Panel Extension Module - 24" High	EVPSGXE2436	640	130	24	36	2 7/8
		EVPSGXE2442	705	141	24	42	2 7/8
		EVPSGXE2448	768	158	24	48	2 7/8

**EVPSGX - TALK THRU GLASS EXTENSION MODULE**

- Talk thru glass module.
- Attaches on top of a panel.
- Module can be stacked to add privacy or divide space.
- Panel extension module is not load bearing if installed higher than 66" High.
- When ordering panel extension modules , additional connectors are required.
- \*Top Trims are not included with Extension Modules.

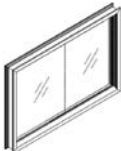
	DESCRIPTION	PRODUCT CODE	PRICE		DIMENSIONS/INCHES		
			CLR	FRS ADD	H	W	D
	Reception Panel Extension Module - 30" High	EVPSGXE3036	698	158	30	36	2 7/8
		EVPSGXE3042	785	160	30	42	2 7/8
		EVPSGXE3048	850	173	30	48	2 7/8

**EVPW1SE - WRITE BOARD EXTENSION MODULE - SINGLE SIDED**

- Attaches on top of a panel.
- Provides writing surface on a Single Side.
- Modules can be stacked to add privacy or to divide space.
- Panel Extension Modules are not load bearing above 66" H.
- When ordering Panel Extension Modules, additional connectors are required.
- High pressure only
- Use erasable Write Board markers only.
- \*Top Trims are not included with Extension Modules.

DESCRIPTION	PRODUCT CODE	LIST PRICE		DIMENSIONS/INCHES		
		Gr1	Gr2	H	W	D
 Write Board Extension Module - Single Sided 6"High	EVPW1SE0618	269	278	6	36	7/8
	EVPW1SE0624	313	323	6	36	2 7/8
	EVPW1SE0636	397	408	6	36	2 7/8
	EVPW1SE0642	450	456	6	42	2 7/8
	EVPW1SE0648	489	502	6	48	2 7/8
	EVPW1SE0654	552	565	6	54	2 7/8
	EVPW1SE0660	580	593	6	60	2 7/8
Write Board Extension Module - Single Sided 12"High	EVPW1SE1218	269	278	12	36	2 7/8
	EVPW1SE1224	313	323	12	36	2 7/8
	EVPW1SE1236	397	408	12	36	2 7/8
	EVPW1SE1242	450	456	12	42	2 7/8
	EVPW1SE1248	489	502	12	48	2 7/8
	EVPW1SE1254	552	565	12	54	2 7/8
	EVPW1SE1260	580	593	12	60	2 7/8
Write Board Extension Module - Single Sided 18"High	EVPW1SE1818	288	299	18	18	2 7/8
	EVPW1SE1824	330	342	18	24	2 7/8
	EVPW1SE1830	372	382	18	30	2 7/8
	EVPW1SE1836	433	448	18	36	2 7/8
	EVPW1SE1842	485	503	18	42	2 7/8
	EVPW1SE1848	532	551	18	48	2 7/8
	EVPW1SE1854	579	598	18	54	2 7/8
EVPW1SE1860	623	645	18	60	2 7/8	
Write Board Extension Module - Single Sided 24"High	EVPW1SE2418	288	299	24	18	2 7/8
	EVPW1SE2424	330	344	24	24	2 7/8
	EVPW1SE2430	372	386	24	30	2 7/8
	EVPW1SE2436	433	450	24	36	2 7/8
	EVPW1SE2442	485	505	24	42	2 7/8
	EVPW1SE2448	532	553	24	48	2 7/8
	EVPW1SE2454	579	598	24	54	2 7/8
EVPW1SE2460	623	646	24	60	2 7/8	

**EVPW2SE - WRITE BOARD EXTENSION MODULE - DOUBLE SIDED**

- Attaches on top of a panel.
- Provides writing surface on two sides.
- Modules can be stacked to add privacy or to divide space.
- Panel Extension Modules are not load bearing above 66" H.
- When ordering Panel Extension Modules, additional connectors are required.
- High pressure only
- Use erasable Write Board markers only.
- \*Top Trims are not included with Extension Modules.

	DESCRIPTION	PRODUCT CODE	LIST PRICE	DIMENSIONS/INCHES			
				H	W	D	
	Write Board Extension Module - Double Sided - 6" High	EVPW2SE0618	289	6	18	2.78	
		EVPW2SE0624	342	6	24	2.78	
		EVPW2SE0630	394	6	30	2.78	
		EVPW2SE0636	452	6	36	2.78	
		EVPW2SE0642	513	6	42	2.78	
		EVPW2SE0648	572	6	48	2.78	
		EVPW2SE0654	660	6	54	2.78	
		EVPW2SE0660	677	6	60	2.78	
		Write Board Extension Module - Double Sided - 12" High	EVPW2SE1218	289	12	18	2.78
			EVPW2SE1224	342	12	24	2.78
EVPW2SE1230	394		12	30	2.78		
EVPW2SE1236	452		12	36	2.78		
EVPW2SE1242	513		12	42	2.78		
EVPW2SE1248	572		12	48	2.78		
EVPW2SE1254	660		12	54	2.78		
EVPW2SE1260	677		12	60	2.78		
Write Board Extension Module - Double Sided - 18" High	EVPW2SE1818	348	18	18	2.78		
	EVPW2SE1824	410	18	24	2.78		
	EVPW2SE1830	471	18	30	2.78		
	EVPW2SE1836	552	18	36	2.78		
	EVPW2SE1842	623	18	42	2.78		
	EVPW2SE1848	695	18	48	2.78		
	EVPW2SE1854	769	18	54	2.78		
	EVPW2SE1860	839	18	60	2.78		
Write Board Extension Module - Double Sided - 24" High	EVPW2SE2418	348	24	18	2.78		
	EVPW2SE2424	410	24	24	2.78		
	EVPW2SE2430	471	24	30	2.78		
	EVPW2SE2436	552	24	36	2.78		
	EVPW2SE2442	623	24	42	2.78		
	EVPW2SE2448	695	24	48	2.78		
	EVPW2SE2454	769	24	54	2.78		
	EVPW2SE2460	839	24	60	2.78		

**EVPH1SE - LAMINATE EXTENSION MODULE - SINGLE SIDED**

- Attaches on top of a panel.
- Laminate face on the module provides a durable, washable surface on Single Side of the panel.
- Modules can be stacked to add privacy or to divide space.
- Panel Extension Modules are not load bearing above 66" H.
- When ordering Panel Extension Modules, additional connectors are required.
- Available in high pressure only.
- \*Top Trims are not included with Extension Modules.

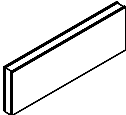
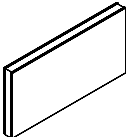
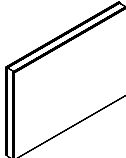
	DESCRIPTION	PRODUCT CODE	LIST PRICE		DIMENSIONS/INCHES		
			Gr1	Gr2	H	W	D
	Laminate Extension Module - Single Sided 6" High	EVPH1SE0618	269	278	6	18	2 7/8
		EVPH1SE0624	313	317	6	24	2 7/8
		EVPH1SE0630	350	353	6	30	2 7/8
		EVPH1SE0636	397	403	6	36	2 7/8
		EVPH1SE0642	450	453	6	42	2 7/8
		EVPH1SE0648	489	503	6	48	2 7/8
		EVPH1SE0654	552	565	6	54	2 7/8
		EVPH1SE0660	580	586	6	60	2 7/8
	Laminate Extension Module - Single Sided 12" High	EVPH1SE1218	269	278	12	18	2 7/8
		EVPH1SE1224	313	324	12	24	2 7/8
		EVPH1SE1230	350	358	12	30	2 7/8
		EVPH1SE1236	397	411	12	36	2 7/8
		EVPH1SE1242	450	460	12	42	2 7/8
		EVPH1SE1248	489	504	12	48	2 7/8
		EVPH1SE1254	552	567	12	54	2 7/8
		EVPH1SE1260	580	595	12	60	2 7/8
	Laminate Extension Module - Single Sided 18" High	EVPH1SE1818	359	369	18	18	2 7/8
		EVPH1SE1824	423	434	18	24	2 7/8
		EVPH1SE1830	487	502	18	30	2 7/8
		EVPH1SE1836	557	572	18	36	2 7/8
		EVPH1SE1842	629	644	18	42	2 7/8
		EVPH1SE1848	690	707	18	48	2 7/8
		EVPH1SE1854	746	768	18	54	2 7/8
		EVPH1SE1860	821	844	18	60	2 7/8
	Laminate Extension Module - Single Sided 24" High	EVPH1SE2418	359	373	24	18	2 7/8
		EVPH1SE2424	423	438	24	24	2 7/8
		EVPH1SE2430	487	505	24	30	2 7/8
		EVPH1SE2436	557	576	24	36	2 7/8
		EVPH1SE2442	629	648	24	42	2 7/8
		EVPH1SE2448	690	710	24	48	2 7/8
		EVPH1SE2454	746	772	24	54	2 7/8
		EVPH1SE2460	821	848	24	60	2 7/8

**EVPH2SE - LAMINATE EXTENSION MODULE - DOUBLE SIDED**

- Attaches on top of a panel.
- Laminate faces on both sides of the module provide durable, washable surfaces
- Modules can be stacked to add privacy or to divide space.
- Panel Extension Modules are not load bearing above 66" H
- When ordering Panel Extension Modules, additional connectors are required.
- Available in high pressure only.
- \*Top Trims are not included with Extension Modules.

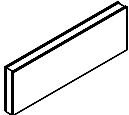
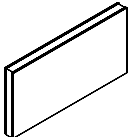
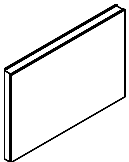
	DESCRIPTION	PRODUCT CODE	LIST PRICE	DIMENSIONS/INCHES		
				H	W	D
	Laminate Extension Module - Double Sided 6" High	EVPH2SE0618	289	6	18	2 7/8
		EVPH2SE0624	342	6	24	2 7/8
		EVPH2SE0630	394	6	30	2 7/8
		EVPH2SE0636	452	6	36	2 7/8
		EVPH2SE0642	513	6	42	2 7/8
		EVPH2SE0648	572	6	48	2 7/8
		EVPH2SE0654	660	6	54	2 7/8
EVPH2SE0660	677	6	60	2 7/8		
	Laminate Extension Module - Double Sided 12" High	EVPH2SE1218	289	12	18	2 7/8
		EVPH2SE1224	342	12	24	2 7/8
		EVPH2SE1230	394	12	30	2 7/8
		EVPH2SE1236	452	12	36	2 7/8
		EVPH2SE1242	513	12	42	2 7/8
		EVPH2SE1248	572	12	48	2 7/8
		EVPH2SE1254	660	12	54	2 7/8
EVPH2SE1260	677	12	60	2 7/8		
	Laminate Extension Module - Double Sided 18" High	EVPH2SE1818	416	18	18	2 7/8
		EVPH2SE1824	502	18	24	2 7/8
		EVPH2SE1830	580	18	30	2 7/8
		EVPH2SE1836	674	18	36	2 7/8
		EVPH2SE1842	760	18	42	2 7/8
		EVPH2SE1848	862	18	48	2 7/8
		EVPH2SE1854	944	18	54	2 7/8
EVPH2SE1860	1017	18	60	2 7/8		
	Laminate Extension Module - Double Sided 24" High	EVPH2SE2418	416	24	18	2 7/8
		EVPH2SE2424	502	24	24	2 7/8
		EVPH2SE2430	580	24	30	2 7/8
		EVPH2SE2436	674	24	36	2 7/8
		EVPH2SE2442	760	24	42	2 7/8
		EVPH2SE2448	862	24	48	2 7/8
		EVPH2SE2454	944	24	54	2 7/8
EVPH2SE2460	1017	24	60	2 7/8		

**EVPAE - AIR FLOW EXTENSION MODULE**

- Metal air flow panel extension
- Attaches to top of panel
- Modules can be stacked to add privacy or to divide space.
- Panel Extension Modules are not load bearing above 66" H.
- When ordering Panel Extension Modules, additional connectors are required.
- \*Top Trims are not included with Extension Modules.

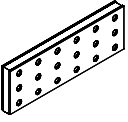
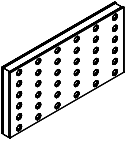
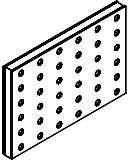
	DESCRIPTION	PRODUCT CODE	LIST PRICE	DIMENSIONS/INCHES		
				H	W	D
	Air Flow Extension Module - 12" High	EVPAE1224	348	12	24	2 7/8
		EVPAE1230	416	12	30	2 7/8
		EVPAE1236	470	12	36	2 7/8
		EVPAE1242	518	12	42	2 7/8
		EVPAE1248	587	12	48	2 7/8
		EVPAE1254	678	18	54	2 7/8
		EVPAE1260	772	12	60	2 7/8
	Air Flow Extension Module - 18" High	EVPAE1824	438	18	24	2 7/8
		EVPAE1830	511	18	30	2 7/8
		EVPAE1836	565	18	36	2 7/8
		EVPAE1842	619	18	42	2 7/8
		EVPAE1848	712	18	48	2 7/8
		EVPAE1854	818	18	54	2 7/8
		EVPAE1860	919	18	60	2 7/8
	Air Flow Extension Module - 24" High	EVPAE2424	438	24	24	2 7/8
		EVPAE2430	511	24	30	2 7/8
		EVPAE2436	565	24	36	2 7/8
		EVPAE2442	619	24	42	2 7/8
		EVPAE2448	712	24	48	2 7/8
		EVPAE2454	810	18	54	2 7/8
		EVPAE2460	919	24	60	2 7/8

**EVPOE - OPEN PANEL EXTENSION MODULE**

- Attaches to top portion of a panel.
- Modules can be stacked to add privacy or to divide space
- Panel Extension Modules are not load bearing above 66" H.
- When ordering Panel Extension Modules, additional connectors are required.
- \*Top Trims are not included with Extension Modules.

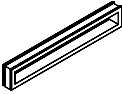
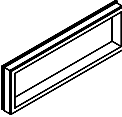
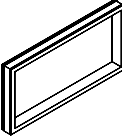
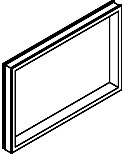
	DESCRIPTION	PRODUCT CODE	LIST PRICE	DIMENSIONS/INCHES		
				H	W	D
	Open Panel Extension Module - 6" High	EVPOE0618	310	6	18	2 7/8
		EVPOE0624	316	6	24	2 7/8
		EVPOE0630	386	6	30	2 7/8
		EVPOE0636	403	6	36	2 7/8
		EVPOE0642	488	6	42	2 7/8
		EVPOE0648	548	6	48	2 7/8
		EVPOE0654	598	6	54	2 7/8
		EVPOE0660	645	6	60	2 7/8
	Open Panel Extension Module - 12" High	EVPOE1218	312	12	18	2 7/8
		EVPOE1224	318	12	24	2 7/8
		EVPOE1230	386	12	30	2 7/8
		EVPOE1236	403	12	36	2 7/8
		EVPOE1242	488	12	42	2 7/8
		EVPOE1248	549	12	48	2 7/8
		EVPOE1254	598	12	54	2 7/8
		EVPOE1260	647	12	60	2 7/8
	Open Panel Extension Module - 18" High	EVPOE1818	454	18	18	2 7/8
		EVPOE1824	462	18	24	2 7/8
		EVPOE1830	488	18	30	2 7/8
		EVPOE1836	534	18	36	2 7/8
		EVPOE1842	601	18	42	2 7/8
		EVPOE1848	678	18	48	2 7/8
		EVPOE1854	735	18	54	2 7/8
		EVPOE1860	791	18	60	2 7/8
	Open Panel Extension Module - 24" High	EVPOE2418	462	24	18	2 7/8
		EVPOE2424	454	24	24	2 7/8
		EVPOE2430	488	24	30	2 7/8
		EVPOE2436	534	24	36	2 7/8
		EVPOE2442	601	24	42	2 7/8
		EVPOE2448	678	24	48	2 7/8
		EVPOE2454	735	24	54	2 7/8
		EVPOE2460	791	24	60	2 7/8

**EVPIECBS - BRIDGE PANEL INLINE EXTENSION CONNECTOR**

- Connects bridge panel to inline extension connector.
- Includes one bridge extension connector and connecting hardware.

	DESCRIPTION	PRODUCT CODE	LIST PRICE	DIMENSIONS/INCHES		
				H	W	D
	Bridge Panel Inline Extension Connector	EVPIECBS06	53	6	3	3
		EVPIECBS12	53	12	3	3
		EVPIECBS18	63	18	3	3
		EVPIECBS24	63	24	3	3

**EVPEERBSA - BRIDGE PANEL END OF RUN EXTENSION CONNECTOR - ALUMINUM TRIM**

- Connects at end of run of bridge panel and can attach panel to fixed wall.
- Adds 1" to width of panel run.
- Provides slotted support for worksurfaces and hang on components up to 66"H.
- Includes one slotted bridge extension connector and connecting hardware and trim kit.

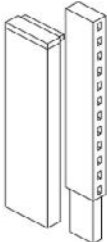
	DESCRIPTION	PRODUCT CODE	LIST PRICE	DIMENSIONS/INCHES		
				H	W	D
	Bridge Panel End of Run Extension Connector	EVPEERBSA06	57	6	3	3
	Aluminum Trim	EVPEERBSA12	57	12	3	3
		EVPEERBSA18	69	18	3	3
		EVPEERBSA24	69	24	3	3

**EVPICBS - BRIDGE PANEL INLINE CONNECTOR WITHOUT ALUMINUM INSERT**

- Connects two bridge panels to inline connector.
- Inline connector in middle between two bridge panels, above opening, using double clamp at bottom.
- Includes one bridge extension connector without aluminum insert, includes connecting hardware.

	DESCRIPTION	PRODUCT CODE	LIST PRICE	DIMENSIONS/INCHES		
				H	W	D
	Bridge Panel Inline Connector	EVPICBS06	53	6	3	3
	without Aluminum Insert	EVPICBS12	53	12	3	3
		EVPICBS18	63	18	3	3
		EVPICBS24	63	24	3	3

**EVPCEPB1 - BRIDGE PANEL CORNER EXTENSION POST 1 WAY**

- Connects at end of a run of extension modules.
- Post and connecting hardware add 3.25" to power beam run.
- Includes one extension post, one slotted extension connectors for bridge panel, connecting hardware and trim kit.

	DESCRIPTION	PRODUCT CODE	LIST PRICE	DIMENSIONS/INCHES		
				H	W	D
	Bridge Panel Inline Extension Connector	EVPCEBSA106	97	6	3	3
		EVPCEBSA112	97	12	3	3
		EVPCEBSA118	122	18	3	3
		EVPCEBSA124	122	24	3	3

**EVPCEPB2 - BRIDGE PANEL CORNER EXTENSION POST 2 WAY**

- Connects two bridge panels in 90 degree configuration.
- Post and connecting hardware add 3.25" to power beam run.
- Includes one extension post, two one slotted extension connectors for bridge panel, connecting hardware and trim kit.

	DESCRIPTION	PRODUCT CODE	LIST PRICE	DIMENSIONS/INCHES		
				H	W	D
	Bridge Panel Corner Extension Post 2 way	EVPCEBSA206	99	6	3	3
		EVPCEBSA212	99	12	3	3
		EVPCEBSA218	156	18	3	3
		EVPCEBSA224	156	24	3	3

**EVPCEPB3 - BRIDGE PANEL CORNER EXTENSION POST 3 WAY**

- Connects three bridge panels in T degree configuration.
- Post and connecting hardware add 3.25" to power beam run.
- Includes one extension post, three one slotted extension connectors for bridge panel, connecting hardware and trim kit.

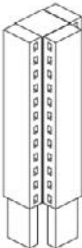
	DESCRIPTION	PRODUCT CODE	LIST PRICE	DIMENSIONS/INCHES		
				H	W	D
	Bridge Panel Corner Extension Post 3 way	EVPCEBSA306	118	6	3	3
		EVPCEBSA312	118	12	3	3
		EVPCEBSA318	182	18	3	3
		EVPCEBSA324	182	24	3	3

**EVPCEPB4 - BRIDGE PANEL CORNER EXTENSION POST 4 WAY**

- Connects four bridge panels in X degree configuration.
- Post and connecting hardware add 3.25" to power beam run.
- Includes one extension post, four one slotted extension connectors for bridge panel, connecting hardware and trim kit.

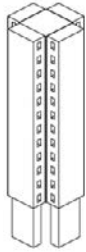

DESCRIPTION	PRODUCT CODE	LIST PRICE	DIMENSIONS/INCHES		
			H	W	D
Bridge Panel Corner Extension Post 4 way	EVPCEPBS406	136	6	3	3
	EVPCEPBS412	136	12	3	3
	EVPCEPBS418	201	18	3	3
	EVPCEPBS424	201	24	3	3

**EVPCEIPBSA2 - BRIDGE PANEL INLINE TWO WAY POST EXTENSION**

- Connects two bridge panels in straight run.
- Post and connecting hardware add 3.25" to power beam run.
- Includes one extension post, two slotted extension connectors for bridge panel, connecting hardware and trim kit.



DESCRIPTION	PRODUCT CODE	LIST PRICE	DIMENSIONS/INCHES		
			H	W	D
Bridge Panel Inline Extension Post 2 way	EVPCEIPBSA206	104	6	3	3
	EVPCEIPBSA212	104	12	3	3
	EVPCEIPBSA218	170	18	3	3
	EVPCEIPBSA224	170	24	3	3

**EVPFEB - FABRIC PANEL BRIDGE MODULE**

- Bridge modules connects two panels above opening.
- Requires bridge extension connectors, connects with clamps on top and at bottom.
- Each side of fabric module may have different fabric within the same grade at no charge.
- If different grades of fabric are used, the entire module must be price at highest grade.
- When ordering bridge modules , additional bridge connectors are required.
- Aluminum trim for bottom to be ordered separately.

	DESCRIPTION	PRODUCT CODE	LIST PRICE		DIMENSIONS/INCHES				
			Gr1	Gr2	H	W	D		
	Fabric Panel Bridge Module - 6" High	EVPFEB0618	198	207	6	18	3		
		EVPFEB0624	201	215	6	24	3		
		EVPFEB0630	220	238	6	30	3		
		EVPFEB0636	244	263	6	36	3		
		EVPFEB0642	277	294	6	42	3		
		EVPFEB0648	297	318	6	48	3		
		EVPFEB0654	320	343	6	54	3		
		EVPFEB0660	344	373	6	60	3		
		Fabric Panel Bridge Module - 12" High	Fabric Panel Bridge Module - 12" High	EVPFEB1218	198	207	12	18	3
				EVPFEB1224	201	215	12	24	3
EVPFEB1230	220			238	12	30	3		
EVPFEB1236	244			263	12	36	3		
EVPFEB1242	277			294	12	42	3		
EVPFEB1248	297			318	12	48	3		
EVPFEB1254	320			343	12	54	3		
EVPFEB1260	344			373	12	60	3		
Fabric Panel Bridge Module - 18" High	Fabric Panel Bridge Module - 18" High	EVPFEB1818	239	257	18	18	3		
		EVPFEB1824	248	269	18	24	3		
		EVPFEB1830	269	298	18	30	3		
		EVPFEB1836	312	342	18	36	3		
		EVPFEB1842	342	380	18	42	3		
		EVPFEB1848	374	413	18	48	3		
		EVPFEB1854	405	449	18	54	3		
		EVPFEB1860	440	488	18	60	3		
Fabric Panel Bridge Module - 24" High	Fabric Panel Bridge Module - 24" High	EVPFEB2418	239	257	24	18	3		
		EVPFEB2424	248	269	24	24	3		
		EVPFEB2430	269	298	24	30	3		
		EVPFEB2436	312	342	24	36	3		
		EVPFEB2442	342	380	24	42	3		
		EVPFEB2448	374	413	24	48	3		
		EVPFEB2454	405	449	24	54	3		
		EVPFEB2460	440	488	24	60	3		

**EVPFPEB - FABRIC PANEL BRIDGE MODULE - PREMIUM**

- Bridge modules connects two panels above opening.
- Requires bridge extension connectors, connects with clamps on top and at bottom.
- Each side of fabric module may have different fabric within the same grade at no charge.
- If different grades of fabric are used, the entire module must be price at highest grade.
- When ordering bridge modules , additional bridge connectors are required.
- Aluminum trim for bottom to be ordered separately.

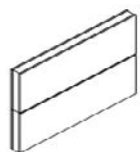
	DESCRIPTION	PRODUCT CODE	LIST PRICE		DIMENSIONS/INCHES		
			Gr1	Gr2	H	W	D
	Fabric Panel Bridge Module - Premium	EVPFPEB2418	323	342	24	18	3
		EVPFPEB2424	344	367	24	24	3
		EVPFPEB2430	386	413	24	30	3
		EVPFPEB2436	434	463	24	36	3
		EVPFPEB2442	487	525	24	42	3
		EVPFPEB2448	523	564	24	48	3
		EVPFPEB2454	577	621	24	54	3
		EVPFPEB2460	630	680	24	60	3

**EVPGTB - TEMPERED GLASS BRIDGE MODULE**

- Bridge modules connects two panels above opening.
- Requires bridge extension connectors, connects with clamps on top and at bottom.
- Standard in clear (CLR) glass.
- Frosted glass (FRST) 40% upcharge. Contact Evolve Customer support for details.
- When ordering bridge modules, additional bridge connectors are required.
- Aluminum trim for bottom to be ordered separately.

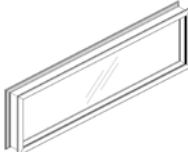
	DESCRIPTION	PRODUCT CODE	LIST PRICE	DIMENSIONS/INCHES			
				H	W	D	
	Tempered Glass Bridge Module - 6" High	EVPGTB0618	380	6	18	3	
		EVPGTB0624	410	6	24	3	
		EVPGTB0630	492	6	30	3	
		EVPGTB0636	515	6	36	3	
		EVPGTB0642	630	6	42	3	
		EVPGTB0648	702	6	48	3	
		EVPGTB0654	768	6	54	3	
		EVPGTB0660	828	6	60	3	
		Tempered Glass Bridge Module - 12" High	EVPGTB1218	380	12	18	3
			EVPGTB1224	410	12	24	3
EVPGTB1230	492		12	30	3		
EVPGTB1236	515		12	36	3		
EVPGTB1242	630		12	42	3		
EVPGTB1248	702		12	48	3		
EVPGTB1254	768		12	54	3		
EVPGTB1260	828		12	60	3		
Tempered Glass Bridge Module - 18" High	EVPGTB1818	571	18	18	3		
	EVPGTB1824	587	18	24	3		
	EVPGTB1830	629	18	30	3		
	EVPGTB1836	686	18	36	3		
	EVPGTB1842	777	18	42	3		
	EVPGTB1848	870	18	48	3		
	EVPGTB1854	944	18	54	3		
	EVPGTB1860	1013	18	60	3		
Tempered Glass Bridge Module - 24" High	EVPGTB2418	571	24	18	3		
	EVPGTB2424	587	24	24	3		
	EVPGTB2430	629	24	30	3		
	EVPGTB2436	686	24	36	3		
	EVPGTB2442	777	24	42	3		
	EVPGTB2448	870	24	48	3		
	EVPGTB2454	944	24	54	3		
	EVPGTB2460	1013	24	60	3		

**EVPGTEB - TEMPERED GLASS BRIDGE MODULE - PREMIUM**

- Bridge modules connects two panels above opening.
- Requires bridge extension connectors, connects with clamps at bottom.
- Standard in clear (CLR) glass.
- Frosted glass (FRST) 40% upcharge. Contact Evolve Customer support for details.
- When ordering bridge modules, additional bridge connectors are required.
- Aluminum trim for bottom to be ordered separately.

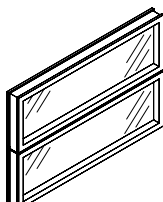
	DESCRIPTION	PRODUCT CODE	LIST PRICE	DIMENSIONS/INCHES		
				H	W	D
	Tempered Glass Bridge Module - Premium	EVPGTEB2418	562	24	18	3
		EVPGTEB2424	623	24	24	3
		EVPGTEB2430	712	24	30	3
		EVPGTEB2436	810	24	36	3
		EVPGTEB2442	898	24	42	3
		EVPGTEB2448	1007	24	48	3
		EVPGTEB2454	1098	24	54	3
		EVPGTEB2460	1189	24	60	3

**EVPW1SEB - WRITE BOARD BRIDGE MODULE - SINGLE SIDED**

- Bridge modules connects two panels above opening.
- Requires bridge extension connectors, connects with clamps at bottom.
- Provides writing surface on Single side.
- Panel extension module is not load bearing if installed higher than 66" High.
- Use erasable Write Board markers only.
- When ordering bridge modules, additional bridge connectors are required.
- Aluminum trim for bottom to be ordered separately.

DESCRIPTION	PRODUCT CODE	LIST PRICE		DIMENSIONS/INCHES		
		Gr1	Gr2	H	W	D
 Write Board Bridge Module - 6" High Single Sided	EVPW1SEB0618	269	278	6	18	3
	EVPW1SEB0624	313	324	6	24	3
	EVPW1SEB0630	350	358	6	30	3
	EVPW1SEB0636	397	411	6	36	3
	EVPW1SEB0642	450	460	6	42	3
	EVPW1SEB0648	489	567	6	48	3
	EVPW1SEB0654	552	567	6	54	3
	EVPW1SEB0660	580	595	6	60	3
	Write Board Bridge Module - 12" High Single Sided	EVPW1SEB1218	269	278	12	18
EVPW1SEB1224		313	324	12	24	3
EVPW1SEB1230		350	358	12	30	3
EVPW1SEB1236		397	411	12	36	3
EVPW1SEB1242		450	460	12	42	3
EVPW1SEB1248		489	504	12	48	3
EVPW1SEB1254		552	567	12	54	3
EVPW1SEB1260		580	595	12	60	3
Write Board Bridge Module - 18" High Single Sided	EVPW1SEB1818	359	373	18	18	3
	EVPW1SEB1824	423	438	18	24	3
	EVPW1SEB1830	487	505	18	30	3
	EVPW1SEB1836	557	576	18	36	3
	EVPW1SEB1842	629	648	18	42	3
	EVPW1SEB1848	690	710	18	48	3
	EVPW1SEB1854	746	772	18	54	3
	EVPW1SEB1860	821	848	18	60	3
Write Board Bridge Module - 24" High Single Sided	EVPW1SEB2418	359	373	24	18	3
	EVPW1SEB2424	423	438	24	24	3
	EVPW1SEB2430	487	505	24	30	3
	EVPW1SEB2436	557	576	24	36	3
	EVPW1SEB2442	629	648	24	42	3
	EVPW1SEB2448	690	710	24	48	3
	EVPW1SEB2454	746	772	24	54	3
	EVPW1SEB2460	821	848	24	60	3

**EVPW2SEB - WRITE BOARD BRIDGE MODULE - DOUBLE SIDED**

- Bridge modules connects two panels above opening.
- Requires bridge extension connectors, connects with clamps at bottom.
- Provides writing surface on Single side.
- Panel extension module is not load bearing if installed higher than 66" High.
- Available in high pressure only.
- Use erasable Write Board markers only.
- When ordering bridge modules, additional bridge connectors are required.
- Aluminum trim for bottom to be ordered separately.

DESCRIPTION	PRODUCT CODE	LIST PRICE	DIMENSIONS/INCHES		
			H	W	D
 Write Board Bridge Module - 6" High Double Sided	EVPW2SEB0618	289	6	18	3
	EVPW2SEB0624	342	6	24	3
	EVPW2SEB0630	394	6	30	3
	EVPW2SEB0636	452	6	36	3
	EVPW2SEB0642	513	6	42	3
	EVPW2SEB0648	572	6	48	3
	EVPW2SEB0654	660	6	54	3
	EVPW2SEB0660	677	6	60	3
Tempered Glass Bridge Module - 12" High Double Sided	EVPW2SEB1218	289	12	18	3
	EVPW2SEB1224	342	12	24	3
	EVPW2SEB1230	394	12	30	3
	EVPW2SEB1236	452	12	36	3
	EVPW2SEB1242	513	12	42	3
	EVPW2SEB1248	572	12	48	3
	EVPW2SEB1254	660	12	54	3
	EVPW2SEB1260	677	12	60	3
Tempered Glass Bridge Module - 18" High Double Sided	EVPW2SEB1818	416	18	18	3
	EVPW2SEB1824	502	18	24	3
	EVPW2SEB1830	580	18	30	3
	EVPW2SEB1836	674	18	36	3
	EVPW2SEB1842	760	18	42	3
	EVPW2SEB1848	862	18	48	3
	EVPW2SEB1854	944	18	54	3
	EVPW2SEB1860	1017	18	60	3
Tempered Glass Bridge Module - 24" High Double Sided	EVPW2SEB2418	416	24	18	3
	EVPW2SEB2424	502	24	24	3
	EVPW2SEB2430	580	24	30	3
	EVPW2SEB2436	674	24	36	3
	EVPW2SEB2442	760	24	42	3
	EVPW2SEB2448	862	24	48	3
	EVPW2SEB2454	944	24	54	3
	EVPW2SEB2460	1017	24	60	3

**EVPH1SEB - LAMINATE BRIDGE MODULE - SINGLE SIDED**

- Bridge modules connects two panels above opening.
- Requires bridge extension connectors, connects with clamps at bottom.
- Laminate face on module provides durable, washable surface on Single side of panel.
- Panel extension module is not load bearing if installed higher than 66" High.
- Available in high pressure only.
- When ordering bridge modules , additional bridge connectors are required.
- Aluminum trim for bottom to be ordered separately.

	DESCRIPTION	PRODUCT CODE	LIST PRICE		DIMENSIONS/INCHES		
			Gr1	Gr2	H	W	D
	Laminate Bridge Module - 6" High Single Sided	EVPH1SEB0618	269	278	6	18	3
		EVPH1SEB0624	313	324	6	24	3
		EVPH1SEB0630	350	358	6	30	3
		EVPH1SEB0636	397	411	6	36	3
		EVPH1SEB0642	450	460	6	42	3
		EVPH1SEB0648	489	504	6	48	3
		EVPH1SEB0654	552	567	6	54	3
	EVPH1SEB0660	580	595	6	60	3	
	Laminate Bridge Module - 12" High Single Sided	EVPH1SEB1218	269	278	12	18	3
		EVPH1SEB1224	313	324	12	24	3
EVPH1SEB1230		350	358	12	30	3	
EVPH1SEB1236		397	411	12	36	3	
EVPH1SEB1242		450	460	12	42	3	
EVPH1SEB1248		489	504	12	48	3	
EVPH1SEB1254		552	567	12	54	3	
EVPH1SEB1260	580	595	12	60	3		
Laminate Bridge Module - 18" High Single Sided	EVPH1SEB1818	359	373	18	18	3	
	EVPH1SEB1824	423	438	18	24	3	
	EVPH1SEB1830	487	505	18	30	3	
	EVPH1SEB1836	557	576	18	36	3	
	EVPH1SEB1842	629	648	18	42	3	
	EVPH1SEB1848	690	710	18	48	3	
	EVPH1SEB1854	746	772	18	54	3	
	EVPH1SEB1860	821	848	18	60	3	
Laminate Bridge Module - 24" High Single Sided	EVPH1SEB2418	359	373	24	18	3	
	EVPH1SEB2424	423	438	24	24	3	
	EVPH1SEB2430	487	505	24	30	3	
	EVPH1SEB2436	557	576	24	36	3	
	EVPH1SEB2442	629	648	24	42	3	
	EVPH1SEB2448	690	710	24	48	3	
	EVPH1SEB2454	746	772	24	54	3	
	EVPH1SEB2460	821	848	24	60	3	

**EVPH2SEB - LAMINATE BRIDGE MODULE - DOUBLE SIDED**

- Bridge modules connects two panels above opening.
- Requires bridge extension connectors, connects with clamps at bottom.
- Laminate face on both sides of the module provides durable, washable surface.
- Panel extension module is not load bearing if installed higher than 66" High.
- When ordering panel extension modules, additional connectors are required.
- Available in high pressure only.
- When ordering bridge modules , additional bridge connectors are required.
- Aluminum trim for bottom to be ordered separately.

DESCRIPTION	PRODUCT CODE	LIST PRICE	DIMENSIONS/INCHES		
			H	W	D
 Laminate Bridge Module - 6" High Double Sided	EVPH2SEB0618	289	6	18	3
	EVPH2SEB0624	342	6	24	3
	EVPH2SEB0630	394	6	30	3
	EVPH2SEB0636	452	6	36	3
	EVPH2SEB0642	513	6	42	3
	EVPH2SEB0648	572	6	48	3
	EVPH2SEB0654	660	6	54	3
	EVPH2SEB0660	677	6	60	3
	Laminate Bridge Module - 12" High Double Sided	EVPH2SEB1218	289	12	18
EVPH2SEB1224		342	12	24	3
EVPH2SEB1230		394	12	30	3
EVPH2SEB1236		452	12	36	3
EVPH2SEB1242		513	12	42	3
EVPH2SEB1248		572	12	48	3
EVPH2SEB1254		660	12	54	3
EVPH2SEB1260		677	12	60	3
Laminate Bridge Module - 18" High Double Sided	EVPH2SEB1818	416	18	18	3
	EVPH2SEB1824	502	18	24	3
	EVPH2SEB1830	580	18	30	3
	EVPH2SEB1836	674	18	36	3
	EVPH2SEB1842	760	18	42	3
	EVPH2SEB1848	862	18	48	3
	EVPH2SEB1854	944	18	54	3
	EVPH2SEB1860	1017	18	60	3
Laminate Bridge Module - 24" High Double Sided	EVPH2SEB2418	416	24	18	3
	EVPH2SEB2424	502	24	24	3
	EVPH2SEB2430	580	24	30	3
	EVPH2SEB2436	674	24	36	3
	EVPH2SEB2442	760	24	42	3
	EVPH2SEB2448	862	24	48	3
	EVPH2SEB2454	944	24	54	3
	EVPH2SEB2460	1017	24	60	3

**EVPMPXXGI6P - 6" H PANEL MOUNT PRIVACY GLASS W/ ALUMINUM TRIM**

- Attaches on top of Evolve Panels to add privacy or divide space.
- Privacy Glass is integrated into the aluminum top trim.
- Aluminum trim must be specified for entire station when ordering panel mount privacy glass.
- Includes aluminum trim with channel and glass tile
- Glass and attachment hardware ship separately.
- Standard in clear (CLR) or frosted (FRST) glass.

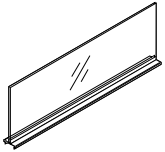
	DESCRIPTION	PRODUCT CODE	LIST PRICE		DIMENSIONS/INCHES		
			Clear	Frosted	H	W	D
	6" H Panel Mount Privacy Glass w/ Aluminum Trim - 24" Wide	EVPMP24GI6P	301	73	6	24	2 7/8
	6" H Panel Mount Privacy Glass w/ Aluminum Trim - 30" Wide	EVPMP30GI6P	326	53	6	30	2 7/8
	6" H Panel Mount Privacy Glass w/ Aluminum Trim - 36" Wide	EVPMP36GI6P	359	38	6	36	2 7/8
	6" H Panel Mount Privacy Glass w/ Aluminum Trim - 42" Wide	EVPMP42GI6P	375	63	6	42	2 7/8
	6" H Panel Mount Privacy Glass w/ Aluminum Trim - 48" Wide	EVPMP48GI6P	385	80	6	48	2 7/8
	6" H Panel Mount Privacy Glass w/ Aluminum Trim - 54" Wide	EVPMP54GI6P	399	100	6	54	2 7/8
	6" H Panel Mount Privacy Glass w/ Aluminum Trim - 60" Wide	EVPMP60GI6P	410	132	6	60	2 7/8
	6" H Panel Mount Privacy Glass w/ Aluminum Trim - 66" Wide	EVPMP66GI6P	475	158	6	66	2 7/8
6" H Panel Mount Privacy Glass w/ Aluminum Trim - 72" Wide	EVPMP72GI6P	488	158	6	72	2 7/8	

**EVMPMPXXGI9P - 9"H PANEL MOUNT PRIVACY GLASS W/ ALUMINUM TRIM**

- Attaches on top of Evolve Panels to add privacy or divide space.
- Privacy Glass is integrated into the aluminum top trim.
- Aluminum trim must be specified for entire station when ordering panel mount privacy glass.
- Includes aluminum trim with channel and glass tile
- Glass and attachment hardware ship separately.
- Standard in clear (CLR) or frosted (FRST) glass.

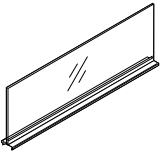
	DESCRIPTION	PRODUCT CODE	LIST PRICE		DIMENSIONS/INCHES		
			Clear	Frosted	H	W	D
	9" H Panel Mount Privacy Glass w/ Aluminum Trim - 24" Wide	EVMPMP24GI9P	301	73	9	24	2 7/8
	9" H Panel Mount Privacy Glass w/ Aluminum Trim - 30" Wide	EVMPMP30GI9P	326	53	9	30	2 7/8
	9" H Panel Mount Privacy Glass w/ Aluminum Trim - 36" Wide	EVMPMP36GI9P	359	38	9	36	2 7/8
	9" H Panel Mount Privacy Glass w/ Aluminum Trim - 42" Wide	EVMPMP42GI9P	375	63	9	42	2 7/8
	9" H Panel Mount Privacy Glass w/ Aluminum Trim - 48" Wide	EVMPMP48GI9P	385	80	9	48	2 7/8
	9" H Panel Mount Privacy Glass w/ Aluminum Trim - 54" Wide	EVMPMP54GI9P	399	100	9	54	2 7/8
	9" H Panel Mount Privacy Glass w/ Aluminum Trim - 60" Wide	EVMPMP60GI9P	410	132	9	60	2 7/8
	9" H Panel Mount Privacy Glass w/ Aluminum Trim - 66" Wide	EVMPMP66GI9P	475	158	9	66	2 7/8
9" H Panel Mount Privacy Glass w/ Aluminum Trim - 72" Wide	EVMPMP72GI9P	488	158	9	72	2 7/8	

**EVPMPXXGIP - 12" PANEL MOUNT PRIVACY GLASS W/ ALUMINUM TRIM**

- Attaches on top of Evolve Panels to add privacy or divide space.
- Privacy Glass is integrated into the aluminum top trim.
- Includes aluminum trim with channel and glass tile.
- Standard in clear (CLR), frosted (FRST) or writeable (WRW) glass.

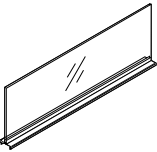
	DESCRIPTION	PRODUCT CODE	LIST PRICE			DIMENSIONS/INCHES		
			CLR	FRST ADD	WRW ADD	H	W	D
	Panel Mount Privacy Glass w/ Aluminum Trim - 24" Wide	EVPMP24GIP	311	73	196	12	24	2 7/8
	Panel Mount Privacy Glass w/ Aluminum Trim - 30" Wide	EVPMP30GIP	338	53	180	12	30	2 7/8
	Panel Mount Privacy Glass w/ Aluminum Trim - 36" Wide	EVPMP36GIP	359	38	171	12	36	2 7/8
	Panel Mount Privacy Glass w/ Aluminum Trim - 42" Wide	EVPMP42GIP	375	63	206	12	42	2 7/8
	Panel Mount Privacy Glass w/ Aluminum Trim - 48" Wide	EVPMP48GIP	395	80	240	12	48	2 7/8
	Panel Mount Privacy Glass w/ Aluminum Trim - 54" Wide	EVPMP54GIP	411	102	275	12	54	2 7/8
	Panel Mount Privacy Glass w/ Aluminum Trim - 60" Wide	EVPMP60GIP	423	132	316	12	60	2 7/8
	Panel Mount Privacy Glass w/ Aluminum Trim - 66" Wide	EVPMP66GIP	475	158	368	12	66	2 7/8
Panel Mount Privacy Glass w/ Aluminum Trim - 72" Wide	EVPMP72GIP	503	158	377	12	72	2 7/8	

**EVPMPNXXGIP - 12" H PANEL MOUNT PRIVACY GLASS W/ NOTCHED TOP TRIM FOR INLINE VARIABLE HEIGHT CONNECTOR**

- Privacy Glass integrated with aluminum top trim.
- Attaches on top of panels to add privacy or divide space.
- Includes aluminum top trim with channel with notched end and glass tile.
- Standard in clear (CLR) or frosted (FRST) glass.
- Aluminium trim must be specified for entire station when ordering panel mount privacy glass.
- Glass and attachment hardware to ship separately

	DESCRIPTION	PRODUCT CODE	LIST PRICE		DIMENSIONS/INCHES		
			Clear	FRST ADD	H	W	D
	Panel Mount Privacy Glass w/ Notched Top Trim for Variable Height Connector - 12" High	EVPMPN24GIP	311	73	12	24	2 7/8
		EVPMPN30GIP	338	53	12	30	2 7/8
		EVPMPN36GIP	359	38	12	36	2 7/8
		EVPMPN42GIP	375	63	12	42	2 7/8
		EVPMPN48GIP	395	80	12	48	2 7/8
		EVPMPN54GIP	411	100	12	54	2 7/8
		EVPMPN60GIP	423	132	12	60	2 7/8

**EVPMPDNXXGIP - 12" H PANEL MOUNT PRIVACY GLASS W/ DOUBLE NOTCHED TOP TRIM FOR INLINE VARIABLE HEIGHT CONNECTOR**

- Privacy Glass integrated with aluminum top trim.
- Attaches on top of panels to add privacy or divide space.
- Includes aluminum top trim with channel with notched ends and glass tile.
- Standard in clear (CLR) or frosted (FRST) glass.
- Aluminium trim must be specified for entire station when ordering panel mount privacy glass.
- Glass and attachment hardware to ship separately.

	DESCRIPTION	PRODUCT CODE	LIST PRICE		DIMENSIONS/INCHES		
			Clear	FRST ADD	H	W	D
	Panel Mount Privacy Glass w/ double notched top trim for variable height connector - 12" High	EVPMPDN24GIP	311	73	12	24	2 7/8
		EVPMPDN30GIP	338	53	12	30	2 7/8
		EVPMPDN36GIP	359	38	12	36	2 7/8
		EVPMPDN42GIP	375	63	12	42	2 7/8
		EVPMPDN48GIP	395	80	12	48	2 7/8
		EVPMPDN54GIP	411	100	12	54	2 7/8
		EVPMPDN60GIP	423	132	12	60	2 7/8

**EVPMPXXGI18P - 18" H PANEL MOUNT PRIVACY GLASS**

- Privacy Glass integrated with aluminum top trim.
- Attaches on top of panels to add privacy or divide space.
- Includes aluminum trim with channel and glass tile.
- Aluminium trim must be specified for entire station when ordering panel mount privacy glass.
- Glass and attachment hardware to ship separately.

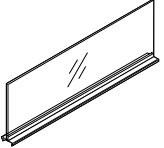
	DESCRIPTION	PRODUCT CODE	LIST PRICE		DIMENSIONS/INCHES		
			Clear	FRST ADD	H	W	D
	18" H Panel Mount Privacy Glass w/ Aluminum Trim - 24" Wide	EVPMP24G118P	464	104	18	24	2 7/8
	18" H Panel Mount Privacy Glass w/ Aluminum Trim - 30" Wide	EVPMP30G118P	503	79	18	30	2 7/8
	18" H Panel Mount Privacy Glass w/ Aluminum Trim - 36" Wide	EVPMP36G118P	537	54	18	36	2 7/8
	18" H Panel Mount Privacy Glass w/ Aluminum Trim - 42" Wide	EVPMP42G118P	560	90	18	42	2 7/8
	18" H Panel Mount Privacy Glass w/ Aluminum Trim - 48" Wide	EVPMP48G118P	593	117	18	48	2 7/8
	18" H Panel Mount Privacy Glass w/ Aluminum Trim - 54" Wide	EVPMP54G118P	615	156	18	54	2 7/8
	18" H Panel Mount Privacy Glass w/ Aluminum Trim - 60" Wide	EVPMP60G118P	635	195	18	60	2 7/8
	18" H Panel Mount Privacy Glass w/ Aluminum Trim - 66" Wide	EVPMP66G118P	712	232	18	66	2 7/8
	18" H Panel Mount Privacy Glass w/ Aluminum Trim - 72" Wide	EVPMP72G118P	753	233	18	72	2 7/8

**EVPMPNXXG118P - 18" H PANEL MOUNT PRIVACY GLASS WITH NOTCHED TOP TRIM FOR VARIABLE HEIGHT CONNECTOR**

- Privacy Glass integrated with aluminum top trim.
- Attaches on top of panels to add privacy or divide space.
- Includes aluminum trim with channel and glass tile.
- Standard in clear (CLR) or frosted (FRST) glass.
- Aluminium trim must be specified for entire station when ordering panel mount privacy glass.
- Glass and attachment hardware to ship separately.

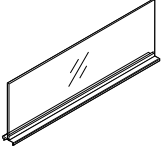
	DESCRIPTION	PRODUCT CODE	LIST PRICE		DIMENSIONS/INCHES		
			Clear	FRST ADD	H	W	D
	18" H Panel Mount Privacy Glass w/ Aluminum Trim - 24" Wide	EVPMPN24G118P	464	104	18	24	2 7/8
	18" H Panel Mount Privacy Glass w/ Aluminum Trim - 30" Wide	EVPMPN30G118P	503	79	18	30	2 7/8
	18" H Panel Mount Privacy Glass w/ Aluminum Trim - 36" Wide	EVPMPN36G118P	537	54	18	36	2 7/8
	18" H Panel Mount Privacy Glass w/ Aluminum Trim - 42" Wide	EVPMPN42G118P	560	90	18	42	2 7/8
	18" H Panel Mount Privacy Glass w/ Aluminum Trim - 48" Wide	EVPMPN48G118P	593	117	18	48	2 7/8
	18" H Panel Mount Privacy Glass w/ Aluminum Trim - 54" Wide	EVPMPN54G118P	615	156	18	54	2 7/8
	18" H Panel Mount Privacy Glass w/ Aluminum Trim - 60" Wide	EVPMPN60G118P	635	195	18	60	2 7/8
	18" H Panel Mount Privacy Glass w/ Aluminum Trim - 66" Wide	EVPMPN66G118P	712	232	18	66	2 7/8
18" H Panel Mount Privacy Glass w/ Aluminum Trim - 72" Wide	EVPMPN72G118P	753	233	18	72	2 7/8	

**EVPMPDNXXGI18P-18"H PANEL MOUNT PRIVACY GLASS WITH DOUBLE NOTCHED TOP TRIM FOR VARIABLE HEIGHT CONNECTOR**

- Privacy Glass integrated with aluminum top trim.
- Attaches on top of panels to add privacy or divide space.
- Includes aluminum trim with channel and glass tile.
- Standard in clear (CLR) or frosted (FRST) glass.
- Aluminium trim must be specified for entire station when ordering panel mount privacy glass.
- Glass and attachment hardware to ship separately.

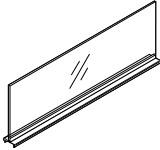
	DESCRIPTION	PRODUCT CODE	LIST PRICE		DIMENSIONS/INCHES		
			Clear	FRST ADD	H	W	D
	18" H Panel Mount Privacy Glass w/ Aluminum Trim - 24" Wide	EVPMPDN24GI18P	464	104	18	24	2 7/8
	18" H Panel Mount Privacy Glass w/ Aluminum Trim - 30" Wide	EVPMPDN30GI18P	503	79	18	30	2 7/8
	18" H Panel Mount Privacy Glass w/ Aluminum Trim - 36" Wide	EVPMPDN36GI18P	537	54	18	36	2 7/8
	18" H Panel Mount Privacy Glass w/ Aluminum Trim - 42" Wide	EVPMPDN42GI18P	560	90	18	42	2 7/8
	18" H Panel Mount Privacy Glass w/ Aluminum Trim - 48" Wide	EVPMPDN48GI18P	593	117	18	48	2 7/8
	18" H Panel Mount Privacy Glass w/ Aluminum Trim - 54" Wide	EVPMPDN54GI18P	615	156	18	54	2 7/8
	18" H Panel Mount Privacy Glass w/ Aluminum Trim - 60" Wide	EVPMPDN60GI18P	635	195	18	60	2 7/8
	18" H Panel Mount Privacy Glass w/ Aluminum Trim - 66" Wide	EVPMPDN66GI18P	712	232	18	66	2 7/8
18" H Panel Mount Privacy Glass w/ Aluminum Trim - 72" Wide	EVPMPDN72GI18P	753	233	18	72	2 7/8	

**EVPMPXXGI6PU - 6" H PANEL MOUNT PRIVACY GLASS FOR U CHANNEL FOR GALLERY PANEL ON ONE END**

- Privacy Glass integrated with aluminum top trim to be used with U channel with connector for Gallery Panels.
- Attaches on top of panels to add privacy or divide space.
- Includes aluminum trim with channel and glass tile.
- Standard in clear (CLR) or frosted (FRST) glass.
- Aluminium trim must be specified for entire station when ordering panel mount privacy glass.
- Glass and attachment hardware to ship separately.
- Trim and glass extended for U channel from one end.

DESCRIPTION	PRODUCT CODE	LIST PRICE		DIMENSIONS/INCHES		
		Clear	FRST ADD	H	W	D
 <p>6" H Panel Mount Privacy Glass U Channel for Gallery Panel</p>	EVPMP24GI6PU	347	52	6	24	5/8
	EVPMP30GI6PU	372	80	6	30	5/8
	EVPMP36GI6PU	386	449	6	36	5/8
	EVPMP42GI6PU	409	80	6	42	5/8
	EVPMP48GI6PU	423	104	6	48	5/8
	EVPMP54GI6PU	436	135	6	54	5/8
	EVPMP60GI6PU	475	157	6	60	5/8
	EVPMP66GI6PU	503	156	6	66	5/8
	EVPMP72GI6PU	532	152	6	72	5/8

**EVPMPXXGI9PU - 9" H PANEL MOUNT PRIVACY GLASS FOR U CHANNEL FOR GALLERY PANEL ON ONE END**

- Privacy Glass integrated with aluminum top trim to be used with U channel with connector for Gallery Panels.
- Attaches on top of panels to add privacy or divide space.
- Includes aluminum trim with channel and glass tile.
- Standard in clear (CLR) or frosted (FRST) glass.
- Aluminium trim must be specified for entire station when ordering panel mount privacy glass.
- Glass and attachment hardware to ship separately.
- Trim and glass extended for U channel from one end.

DESCRIPTION	PRODUCT CODE	LIST PRICE		DIMENSIONS/INCHES		
		Clear	FRST ADD	H	W	D
 <p>9" H Panel Mount Privacy Glass U Channel for Gallery Panel</p>	EVPMP24GI9PU	347	52	9	24	5/8
	EVPMP30GI9PU	406	80	9	30	5/8
	EVPMP36GI9PU	446	449	9	36	5/8
	EVPMP42GI9PU	488	80	9	42	5/8
	EVPMP48GI9PU	527	104	9	48	5/8
	EVPMP54GI9PU	570	135	9	54	5/8
	EVPMP60GI9PU	475	157	9	60	5/8
	EVPMP66GI9PU	503	156	9	66	5/8
	EVPMP72GI9PU	532	152	9	72	5/8

**EVPMPXXGI12PU - 12" H PANEL MOUNT PRIVACY GLASS FOR U CHANNEL FOR GALLERY PANEL ON ONE END**

- Privacy Glass integrated with aluminum top trim to be used with U channel with connector for Gallery Panels.
- Attaches on top of panels to add privacy or divide space.
- Includes aluminum trim with channel and glass tile.
- Standard in clear (CLR) or frosted (FRST) glass.
- Aluminium trim must be specified for entire station when ordering panel mount privacy glass.
- Glass and attachment hardware to ship separately.
- Trim and glass extended for U channel from one end.

DESCRIPTION	PRODUCT CODE	LIST PRICE		DIMENSIONS/INCHES		
		Clear	FRST ADD	H	W	D
 <p>12" H Panel Mount Privacy Glass U Channel for Gallery Panel</p>	EVPMP24GI12PU	347	52	12	24	5/8
	EVPMP30GI12PU	372	80	12	30	5/8
	EVPMP36GI12PU	386	449	12	36	5/8
	EVPMP42GI12PU	409	80	12	42	5/8
	EVPMP48GI12PU	423	104	12	48	5/8
	EVPMP54GI12PU	436	135	12	54	5/8
	EVPMP60GI12PU	475	157	12	60	5/8
	EVPMP66GI12PU	503	156	12	66	5/8
	EVPMP72GI12PU	532	152	12	72	5/8

**EVPMPXXGI18PU - 18" H PANEL MOUNT PRIVACY GLASS FOR U CHANNEL FOR GALLERY PANEL ON ONE END**

- Privacy Glass integrated with aluminum top trim to be used with U channel with connector for Gallery Panels.
- Attaches on top of panels to add privacy or divide space.
- Includes aluminum trim with channel and glass tile.
- Standard in clear (CLR) or frosted (FRST) glass.
- Aluminium trim must be specified for entire station when ordering panel mount privacy glass.
- Glass and attachment hardware to ship separately.
- Trim and glass extended for U channel from one end.

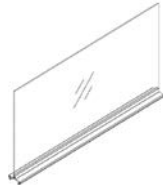

DESCRIPTION	PRODUCT CODE	LIST PRICE		DIMENSIONS/INCHES		
		Clear	FRST ADD	H	W	D
18" H Panel Mount Privacy Glass U Channel for Gallery Panel	EVPMP24GI18PU	503	76	18	24	5/8
	EVPMP30GI18PU	537	53	18	30	5/8
	EVPMP36GI18PU	560	613	18	36	5/8
	EVPMP42GI18PU	593	116	18	42	5/8
	EVPMP48GI18PU	615	151	18	48	5/8
	EVPMP54GI18PU	635	193	18	54	5/8
	EVPMP60GI18PU	712	228	18	60	5/8
	EVPMP66GI18PU	753	232	18	66	5/8
	EVPMP72GI18PU	796	233	18	72	5/8

**EVPMPXXGI6PDU - 6" H PANEL MOUNT PRIVACY GLASS FOR U CHANNEL FOR GALLERY PANELS ON BOTH ENDS**

- Privacy Glass integrated with aluminum top trim to be used with U channel with connector for Gallery Panels.
- Attaches on top of panels to add privacy or divide space.
- Includes aluminum trim with channel and glass tile.
- Standard in clear (CLR) or frosted (FRST) glass.
- Aluminium trim must be specified for entire station when ordering panel mount privacy glass.
- Glass and attachment hardware to ship separately.
- Trim and glass extended for U channel from both ends.



DESCRIPTION	PRODUCT CODE	LIST PRICE		DIMENSIONS/INCHES		
		Clear	FRST ADD	H	W	D
6" H Panel Mount Privacy Glass U Channel for Gallery Panel	EVPMP24GI6PDU	347	52	6	25	1/4
	EVPMP30GI6PDU	369	38	6	31	1/4
	EVPMP36GI6PDU	386	449	6	37	1/4
	EVPMP42GI6PDU	408	81	6	43	1/4
	EVPMP48GI6PDU	423	104	6	49	1/4
	EVPMP54GI6PDU	436	135	6	55	1/4
	EVPMP60GI6PDU	475	157	6	61	1/4
	EVPMP66GI6PDU	503	156	6	67	1/4
	EVPMP72GI6PDU	532	152	6	73	1/4

**EVPMPXXGI9PDU - 9" H PANEL MOUNT PRIVACY GLASS FOR U CHANNEL FOR GALLERY PANELS ON BOTH ENDS**

- Privacy Glass integrated with aluminum top trim to be used with U channel with connector for Gallery Panels.
- Attaches on top of panels to add privacy or divide space.
- Includes aluminum trim with channel and glass tile.
- Standard in clear (CLR) or frosted (FRST) glass.
- Aluminium trim must be specified for entire station when ordering panel mount privacy glass.
- Glass and attachment hardware to ship separately.
- Trim and glass extended for U channel from both ends.



DESCRIPTION	PRODUCT CODE	LIST PRICE		DIMENSIONS/INCHES		
		Clear	FRST ADD	H	W	D
9" H Panel Mount Privacy Glass U Channel for Gallery Panel	EVPMP24GI9PDU	347	52	9	25	1/4
	EVPMP30GI9PDU	369	38	9	31	1/4
	EVPMP36GI9PDU	386	449	9	37	1/4
	EVPMP42GI9PDU	408	81	9	43	1/4
	EVPMP48GI9PDU	423	104	9	49	1/4
	EVPMP54GI9PDU	436	135	9	55	1/4
	EVPMP60GI9PDU	475	157	9	61	1/4
	EVPMP66GI9PDU	503	156	9	67	1/4
	EVPMP72GI9PDU	532	152	9	73	1/4

**EVPMPXXGIPDU - 12" H PANEL MOUNT PRIVACY GLASS FOR U CHANNEL FOR GALLERY PANELS ON BOTH ENDS**

- Privacy Glass integrated with aluminum top trim to be used with U channel with connector for Gallery Panels.
- Attaches on top of panels to add privacy or divide space.
- Includes aluminum trim with channel and glass tile.
- Standard in clear (CLR) or frosted (FRST) glass.
- Aluminium trim must be specified for entire station when ordering panel mount privacy glass.
- Glass and attachment hardware to ship separately.
- Trim and glass extended for U channel from both ends.

	DESCRIPTION	PRODUCT CODE	LIST PRICE		DIMENSIONS/INCHES		
			Clear	FRST ADD	H	W	D
	12" H Panel Mount Privacy Glass	EVPMP24GIPDU	347	52	12	25 1/4	
	U Channel for Gallery Panel	EVPMP30GIPDU	369	38	12	31 1/4	
		EVPMP36GIPDU	386	449	12	37 1/4	
		EVPMP42GIPDU	408	81	12	43 1/4	
		EVPMP48GIPDU	423	104	12	49 1/4	
		EVPMP54GIPDU	436	135	12	55 1/4	
		EVPMP60GIPDU	475	157	12	61 1/4	
		EVPMP66GIPDU	503	156	12	67 1/4	
		EVPMP72GIPDU	532	152	12	73 1/4	

**EVPMPXXGI18PDU - 18" H PANEL MOUNT PRIVACY GLASS FOR U CHANNEL FOR GALLERY PANELS ON BOTH ENDS**

- Privacy Glass integrated with aluminum top trim to be used with U channel with connector for Gallery Panels.
- Attaches on top of panels to add privacy or divide space.
- Includes aluminum trim with channel and glass tile.
- Standard in clear (CLR) or frosted (FRST) glass.
- Aluminium trim must be specified for entire station when ordering panel mount privacy glass.
- Glass and attachment hardware to ship separately.
- Trim and glass extended for U channel from both ends.

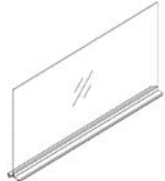
	DESCRIPTION	PRODUCT CODE	LIST PRICE		DIMENSIONS/INCHES		
			Clear	FRST ADD	H	W	D
	18" H Panel Mount Privacy Glass	EVPMP24GI18PDU	504	74	18	25 1/4	
	U Channel for Gallery Panel	EVPMP30GI18PDU	537	53	18	31 1/4	
		EVPMP36GI18PDU	559	650	18	37 1/4	
		EVPMP42GI18PDU	593	116	18	43 1/4	
		EVPMP48GI18PDU	615	151	18	49 1/4	
		EVPMP54GI18PDU	635	193	18	55 1/4	
		EVPMP60GI18PDU	711	232	18	61 1/4	
		EVPMP66GI18PDU	754	228	18	67 1/4	
		EVPMP72GI18PDU	796	80	18	73 1/4	

**EVMPXXGI6W - 6" H PRIVACY GLASS W/ ALUMINUM TRIM FOR 1" LAMINATE PANEL**

- Attaches on top of Evolve 1" Laminate Panels to add privacy or divide space.
- Privacy Glass is integrated into the aluminum top trim.
- Aluminum trim has rail for accessories.
- Includes aluminum trim with end caps and glass tile
- Glass and attachment hardware ship separately.
- Standard in clear (CLR) or frosted (FRST) glass.



DESCRIPTION	PRODUCT CODE	LIST PRICE		DIMENSIONS/INCHES		
		Clear	FRST ADD	H	W	D
6" H Privacy Glass w/ Aluminum Trim for 1" Laminate Panel - 24" Wide	EVMPMP24GI6W	311	73	6	24	1
6" H Privacy Glass w/ Aluminum Trim for 1" Laminate Panel- 30" Wide	EVMPMP30GI6W	338	53	6	30	1
6" H Privacy Glass w/ Aluminum Trim for 1" Laminate Panel - 36" Wide	EVMPMP36GI6W	359	38	6	36	1
6" H Privacy Glass w/ Aluminum Trim for 1" Laminate Panel- 42" Wide	EVMPMP42GI6W	375	63	6	42	1
6" H Privacy Glass w/ Aluminum Trim for 1" Laminate Panel- 48" Wide	EVMPMP48GI6W	395	80	6	48	1

**EVMPXXGI9W - 9" H PRIVACY GLASS W/ ALUMINUM TRIM FOR 1" LAMINATE PANEL**

- Attaches on top of Evolve 1" Laminate Panels to add privacy or divide space.
- Privacy Glass is integrated into the aluminum top trim.
- Aluminum trim has rail for accessories.
- Includes aluminum trim with end caps and glass tile
- Glass and attachment hardware ship separately.
- Standard in clear (CLR) or frosted (FRST) glass.



DESCRIPTION	PRODUCT CODE	LIST PRICE		DIMENSIONS/INCHES		
		Clear	FRST ADD	H	W	D
9" H Privacy Glass w/ Aluminum Trim for 1" Laminate Panel - 24" Wide	EVMPMP24GI9W	311	73	9	24	1
9" H Privacy Glass w/ Aluminum Trim for 1" Laminate Panel- 30" Wide	EVMPMP30GI9W	338	53	9	30	1
9" H Privacy Glass w/ Aluminum Trim for 1" Laminate Panel - 36" Wide	EVMPMP36GI9W	359	38	9	36	1
9" H Privacy Glass w/ Aluminum Trim for 1" Laminate Panel- 42" Wide	EVMPMP42GI9W	375	63	9	42	1
9" H Privacy Glass w/ Aluminum Trim for 1" Laminate Panel- 48" Wide	EVMPMP48GI9W	395	80	9	48	1

**EVMPXXGIW - 12" H PRIVACY GLASS W/ ALUMINUM TRIM FOR 1" LAMINATE PANEL**

- Attaches on top of Evolve 1" Laminate Panels to add privacy or divide space.
- Privacy Glass is integrated into the aluminum top trim.
- Aluminum trim has rail for accessories.
- Includes aluminum trim with end caps and glass tile
- Glass and attachment hardware ship separately.
- Standard in clear (CLR), frosted (FRST) or writeable (WRW) glass.

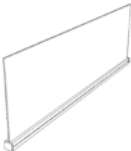
	DESCRIPTION	PRODUCT CODE	LIST PRICE			DIMENSIONS/INCHES		
			CLR	FRST ADD	WRW ADD	H	W	D
	12" H Privacy Glass w/ Aluminum Trim for 1" Laminate Panel - 24" Wide	EVMP24GIW	311	73	196	12	24	1
	12" H Privacy Glass w/ Aluminum Trim for 1" Laminate Panel - 30" Wide	EVMP30GIW	338	53	180	12	30	1
	12" H Privacy Glass w/ Aluminum Trim for 1" Laminate Panel - 36" Wide	EVMP36GIW	359	38	170	12	36	1
	12" H Privacy Glass w/ Aluminum Trim for 1" Laminate Panel - 42" Wide	EVMP42GIW	375	63	206	12	42	1
	12" H Privacy Glass w/ Aluminum Trim for 1" Laminate Panel - 48" Wide	EVMP48GIW	395	80	239	12	48	1

**EVFPDW - 6" H FELT DIVIDER W/ ALUMINUM TRIM FOR 1" LAMINATE PANEL**

- Privacy Felt Divider integrated with aluminum top trim.
- Attaches on top of laminate panels to add privacy or divide space.
- Includes aluminum trim with channel and felt tile.
- Felt and attachment hardware to ship separately.
- 9 mm felt material is tackable and comes in 9 different colors. Please specify color.
- Aluminum top trim available in standard paint finishes.

	DESCRIPTION	PRODUCT CODE	LIST PRICE	DIMENSIONS/INCHES		
				H	W	D
	6" H Felt Divider w/ Aluminum Trim for 1" Laminate Panel	EVFPD0624W	125	6	24	1
		EVFPD0630W	145	6	30	1
		EVFPD0636W	172	6	36	1
		EVFPD0642W	193	6	42	1
		EVFPD0648W	283	6	48	1
		EVFPD0654W	310	6	54	1
		EVFPD0660W	332	6	60	1
		EVFPD0666W	350	6	66	1
		EVFPD0672W	395	6	72	1

**EVFPDW - 9" H FELT DIVIDER W/ ALUMINUM TRIM FOR 1" LAMINATE PANEL**

- Privacy Felt Divider integrated with aluminum top trim.
- Attaches on top of laminate panels to add privacy or divide space.
- Includes aluminum trim with channel and felt tile.
- Felt and attachment hardware to ship separately.
- 9 mm felt material is tackable and comes in 9 different colors. Please specify color.
- Aluminum top trim available in standard paint finishes.

	DESCRIPTION	PRODUCT CODE	LIST PRICE	DIMENSIONS/INCHES		
				H	W	D
	9" H Felt Divider w/ Aluminum Trim for 1" Laminate Panel	EVFPD0924W	125	9	24	1
		EVFPD0930W	145	9	30	1
		EVFPD0936W	172	9	36	1
		EVFPD0942W	193	9	42	1
		EVFPD0948W	283	9	48	1
		EVFPD0954W	310	9	54	1
		EVFPD0960W	332	9	60	1
		EVFPD0966W	350	9	66	1
		EVFPD0972W	395	9	72	1

**EVFPDW - 12" H FELT DIVIDER W/ ALUMINUM TRIM FOR 1" LAMINATE PANEL**

- Privacy Felt Divider integrated with aluminum top trim.
- Attaches on top of laminate panels to add privacy or divide space.
- Includes aluminum trim with channel and felt tile.
- Felt and attachment hardware to ship separately.
- 9 mm felt material is tackable and is available in standard PET colors. Please specify.
- Aluminum top trim available in standard paint finishes.

DESCRIPTION	PRODUCT CODE	LIST PRICE	DIMENSIONS/INCHES		
			H	W	D
 <p>12" H Felt Divider w/ Aluminum Trim for 1" Laminate Panel</p>	EVFPD1224W	125	12	24	1
	EVFPD1230W	145	12	30	1
	EVFPD1236W	172	12	36	1
	EVFPD1242W	193	12	42	1
	EVFPD1248W	283	12	48	1
	EVFPD1254W	310	12	54	1
	EVFPD1260W	332	12	60	1
	EVFPD1266W	350	12	66	1
	EVFPD1272W	395	12	72	1

**EVFPDW - 18" H FELT DIVIDER W/ ALUMINUM TRIM FOR 1" LAMINATE PANEL**

- Privacy Felt Divider integrated with aluminum top trim.
- Attaches on top of laminate panels to add privacy or divide space.
- Includes aluminum trim with channel and felt tile.
- Felt and attachment hardware to ship separately.
- 9 mm felt material is tackable and is available in standard PET colors. Please specify..
- Aluminum top trim available in standard paint finishes.

DESCRIPTION	PRODUCT CODE	LIST PRICE	DIMENSIONS/INCHES		
			H	W	D
 <p>18" H Felt Divider w/ Aluminum Trim for 1" Laminate Panel</p>	EVFPD1824W	156	18	24	1
	EVFPD1830W	181	18	30	1
	EVFPD1836W	214	18	36	1
	EVFPD1842W	239	18	42	1
	EVFPD1848W	353	18	48	1
	EVFPD1854W	385	18	54	1
	EVFPD1860W	416	18	60	1
	EVFPD1866W	436	18	66	1
	EVFPD1872W	495	18	72	1

**EVFDK06P - 6" PANEL MOUNTED FELT DIVIDER**

- Privacy felt panel integrated with aluminum top trim.
- Attaches on top of panels to add privacy or divide space. Includes aluminum trim with channel and felt tile.
- Aluminum trim must be specified for entire station when ordering panel mount privacy felt.
- Felt and attachment hardware to ship separately.
- 9 mm felt material is tackable and is available in standard PET colors. Please specify.

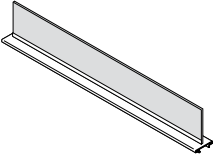
DESCRIPTION	PRODUCT CODE	LIST PRICE Gr1	DIMENSIONS/INCHES		
			H	W	D
 <p>6" Privacy felt panel integrated with aluminum top trim</p>	EVFDK0624P	125	6	24	2 7/8
	EVFDK0630P	145	6	30	2 7/8
	EVFDK0636P	172	6	36	2 7/8
	EVFDK0642P	193	6	42	2 7/8
	EVFDK0648P	283	6	48	2 7/8
	EVFDK0654P	310	6	54	2 7/8
	EVFDK0660P	332	6	60	2 7/8
	EVFDK0666P	350	6	66	2 7/8
	EVFDK0672P	395	6	72	2 7/8

**EVFDK09P - 9" PANEL MOUNTED FELT DIVIDER**

- Privacy felt panel integrated with aluminum top trim.
- Attaches on top of panels to add privacy or divide space. Includes aluminum trim with channel and felt tile.
- Aluminum trim must be specified for entire station when ordering panel mount privacy felt.
- Felt and attachment hardware to ship separately.
- 9 mm felt material is tackable and is available in standard PET colors. Please specify.

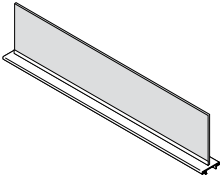
DESCRIPTION	PRODUCT CODE	LIST PRICE Gr1	DIMENSIONS/INCHES		
			H	W	D
 <p>9" Privacy felt panel integrated with aluminum top trim</p>	EVFDK0924P	125	9	24	2 7/8
	EVFDK0930P	145	9	30	2 7/8
	EVFDK0936P	172	9	36	2 7/8
	EVFDK0942P	193	9	42	2 7/8
	EVFDK0948P	283	9	48	2 7/8
	EVFDK0954P	310	9	54	2 7/8
	EVFDK0960P	332	9	60	2 7/8
	EVFDK0966P	350	9	66	2 7/8
	EVFDK0972P	395	9	72	2 7/8

**EVFDK12P - 12" PANEL MOUNTED FELT DIVIDER**

- Privacy felt panel integrated with aluminum top trim.
- Attaches on top of panels to add privacy or divide space. Includes aluminum trim with channel and felt tile.
- Aluminum trim must be specified for entire station when ordering panel mount privacy felt.
- Felt and attachment hardware to ship separately.
- 9 mm felt material is tackable and is available in standard PET colors. Please specify.

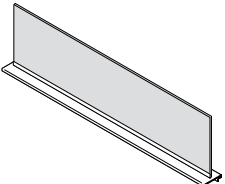
DESCRIPTION	PRODUCT CODE	LIST PRICE Gr1	DIMENSIONS/INCHES		
			H	W	D
 <p>12" Privacy felt panel integrated with aluminum top trim</p>	EVFDK1224P	125	12	24	2 7/8
	EVFDK1230P	145	12	30	2 7/8
	EVFDK1236P	172	12	36	2 7/8
	EVFDK1242P	193	12	42	2 7/8
	EVFDK1248P	283	12	48	2 7/8
	EVFDK1254P	310	12	54	2 7/8
	EVFDK1260P	332	12	60	2 7/8

**EVFDK12PN - 12" PANEL MOUNTED FELT DIVIDER, 1 NOTCH**

- Privacy felt panel integrated with aluminum top trim.
- Attaches on top of panels to add privacy or divide space. Includes aluminum trim with channel and felt tile.
- Aluminum trim must be specified for entire station when ordering panel mount privacy felt.
- Felt and attachment hardware to ship separately.
- 9 mm felt material is tackable and is available in standard PET colors. Please specify.

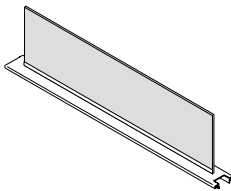
DESCRIPTION	PRODUCT CODE	LIST PRICE Gr1	DIMENSIONS/INCHES		
			H	W	D
 <p>12" Privacy felt panel integrated with aluminum top trim with 1 Notch</p>	EVFDK1224PN	125	12	22.68	2 7/8
	EVFDK1230PN	145	12	28.68	2 7/8
	EVFDK1236PN	172	12	34.68	2 7/8
	EVFDK1242PN	193	12	40.68	2 7/8
	EVFDK1248PN	283	12	46.68	2 7/8
	EVFDK1254PN	310	12	52.68	2 7/8
	EVFDK1260PN	332	12	58.68	2 7/8

**EVFDK12PDN - 12" PANEL MOUNTED FELT DIVIDER, 2 NOTCHES**

- Privacy felt panel integrated with aluminum top trim.
- Attaches on top of panels to add privacy or divide space. Includes aluminum trim with channel and felt tile.
- Aluminum trim must be specified for entire station when ordering panel mount privacy felt.
- Felt and attachment hardware to ship separately.
- 9 mm felt material is tackable and is available in standard PET colors. Please specify.

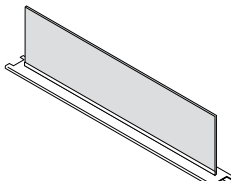
DESCRIPTION	PRODUCT CODE	LIST PRICE Gr1	DIMENSIONS/INCHES		
			H	W	D
 <p>12" Privacy felt panel integrated with aluminum top trim with 2 Notches</p>	EVFDK1224PDN	125	12	21.44	2 7/8
	EVFDK1230PDN	145	12	27.44	2 7/8
	EVFDK1236PDN	172	12	33.44	2 7/8
	EVFDK1242PDN	193	12	39.44	2 7/8
	EVFDK1248PDN	283	12	45.44	2 7/8
	EVFDK1254PDN	310	12	51.44	2 7/8
	EVFDK1260PDN	332	12	57.44	2 7/8

**EVFPDK06XXPCF - 6" H PANEL MOUNT PRIVACY DIVIDER CEILING FILLER KIT**

- Privacy Felt Divider integrated with aluminum top trim.
- Aluminum top trim available in standard paint finishes.
- Attaches on top of panels to add privacy or divide space.
- Includes aluminum trim with channel and Felt tile.
- Felt tile and attachment hardware to ship separately.
- 9 mm felt material is tackable and is available in standard PET colors. Please specify.
- PVC cap for closing gap at ceiling included.
- PVC cap available in white only.

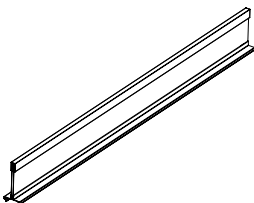
DESCRIPTION	PRODUCT CODE	LIST PRICE	DIMENSIONS/INCHES		
			H	W	D
 Panel Mount Felt Divider Ceiling Filler Kit	EVFDK0618PCF	118	6	18	
	EVFDK0624PCF	141	6	24	
	EVFDK0630PCF	167	6	30	
	EVFDK0636PCF	196	6	36	
	EVFDK0642PCF	221	6	42	
	EVFDK0648PCF	326	6	48	
	EVFDK0654PCF	353	6	54	
	EVFDK0660PCF	384	6	60	
	EVFDK0666PCF	403	6	66	
	EVFDK0672PCF	454	6	72	

**EVFPDK06XXPCFP - 6" H PANEL MOUNT PRIVACY DIVIDER CEILING FILLER KIT**

- Privacy Felt Divider integrated with aluminum top trim.
- Aluminum top trim available in standard paint finishes.
- Aluminum trim is width of panel.
- Attaches on top of panels to add privacy or divide space.
- Includes aluminum trim with channel and Felt tile.
- Felt tile and attachment hardware to ship separately.
- 9 mm felt material is tackable and is available in standard PET colors. Please specify.
- Felt tile is longer and overhangs half of width of post.
- PVC cap for closing gap at ceiling included.
- PVC cap available in white only.

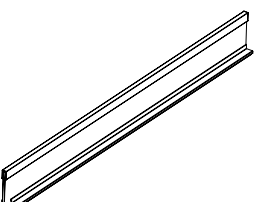
DESCRIPTION	PRODUCT CODE	LIST PRICE	DIMENSIONS/INCHES		
			H	W	D
 Panel Mount Felt Divider Ceiling Filler at Post Kit	EVFDK0619PCF	141	6	19 3/4	
	EVFDK0625PCF	167	6	25 3/4	
	EVFDK0631PCF	196	6	31 3/4	
	EVFDK0637PCF	221	6	37 3/4	
	EVFDK0643PCF	326	6	43 3/4	
	EVFDK0649PCF	353	6	49 3/4	
	EVFDK0655PCF	384	6	55 3/4	
	EVFDK0661PCF	403	6	61 3/4	
	EVFDK0667PCF	454	6	67 3/4	
	EVFDK0673PCF	509	6	73 3/4	

**EVFPDK09XXPCF - 9" H PANEL MOUNT PRIVACY DIVIDER CEILING FILLER KIT**

- Privacy Felt Divider integrated with aluminum top trim.
- Aluminum top trim available in standard paint finishes.
- Attaches on top of panels to add privacy or divide space.
- Includes aluminum trim with channel and Felt tile.
- Felt tile and attachment hardware to ship separately.
- 9 mm felt material is tackable and is available in standard PET colors. Please specify.
- PVC cap for closing gap at ceiling included.
- PVC cap available in white only.

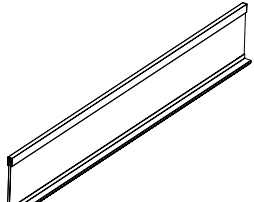
DESCRIPTION	PRODUCT CODE	LIST PRICE	DIMENSIONS/INCHES		
			H	W	D
 Panel Mount Felt Divider Ceiling Filler Kit	EVFDK0918PCF	118	9	18	
	EVFDK0924PCF	141	9	24	
	EVFDK0930PCF	167	9	30	
	EVFDK0936PCF	196	9	36	
	EVFDK0942PCF	221	9	42	
	EVFDK0948PCF	326	9	48	
	EVFDK0954PCF	353	9	54	
	EVFDK0960PCF	384	9	60	
	EVFDK0966PCF	403	9	66	
	EVFDK0972PCF	454	9	72	

**EVFPDK09XXPCFP - 9" H PANEL MOUNT PRIVACY DIVIDER CEILING FILLER KIT**

- Privacy Felt Divider integrated with aluminum top trim.
- Aluminum trim is width of panel.
- Aluminum top trim available in standard paint finishes.
- Attaches on top of panels to add privacy or divide space.
- Includes aluminum trim with channel and Felt tile.
- Felt tile and attachment hardware to ship separately.
- 9 mm felt material is tackable and is available in standard PET colors. Please specify.
- Felt tile is longer and overhangs half of width of post.
- PVC cap for closing gap at ceiling included.
- PVC cap available in white only.

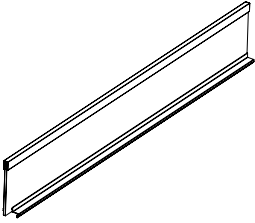
DESCRIPTION	PRODUCT CODE	LIST PRICE	DIMENSIONS/INCHES		
			H	W	D
 Panel Mount Felt Divider Ceiling Filler at Post Kit	EVFDK0919PCF	141	9	19 3/4	
	EVFDK0925PCF	167	9	25 3/4	
	EVFDK0931PCF	196	9	31 3/4	
	EVFDK0937PCF	221	9	37 3/4	
	EVFDK0943PCF	326	9	43 3/4	
	EVFDK0949PCF	353	9	49 3/4	
	EVFDK0955PCF	384	9	55 3/4	
	EVFDK0961PCF	403	9	61 3/4	
	EVFDK0967PCF	454	9	67 3/4	
	EVFDK0973PCF	509	9	73 3/4	

**EVPTFC - CEILING FILLER PVC CAP FOR FELT DIVIDER**

- To be installed on top on felt divider when used as ceiling filler.
- Field installed on top of felt divider to close gap at ceiling.
- Available in 18"-96" lengths.
- Available in white only.
- Felt divider with top trim kit to be ordered separately.

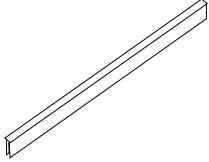
DESCRIPTION	PRODUCT CODE	LIST PRICE	DIMENSIONS/INCHES		
			H	W	D
 PVC Cap for Felt Divider	EVPTFC18	19	1 3/8	18	3/4
	EVPTFC24	21	1 3/8	24	3/4
	EVPTFC30	26	1 3/8	30	3/4
	EVPTFC36	29	1 3/8	36	3/4
	EVPTFC42	32	1 3/8	42	3/4
	EVPTFC48	47	1 3/8	48	3/4
	EVPTFC54	51	1 3/8	54	3/4
	EVPTFC60	53	1 3/8	60	3/4
	EVPTFC66	57	1 3/8	66	3/4
	EVPTFC72	63	1 3/8	72	3/4
	EVPTFC78	69	1 3/8	78	3/4
	EVPTFC84	74	1 3/8	84	3/4
	EVPTFC90	81	1 3/8	90	3/4
	EVPTFC96	87	1 3/8	96	3/4

**EVFELTPXXHWR - ALUMINUM TOP TRIM WITH CHANNEL**

- Top trim with channel.
- Available in standard paint colors.
- Note: Trim can span inline connector, but not a Post

DESCRIPTION	PRODUCT CODE	LIST PRICE	DIMENSIONS/INCHES		
			H	W	D
 Aluminum Top Trip	EVFELTP18HWR	47		18	2.875
	EVFELTP24HWR	48		24	2.875
	EVFELTP30HWR	55		30	2.875
	EVFELTP36HWR	61		36	2.875
	EVFELTP42HWR	69		42	2.875
	EVFELTP48HWR	75		48	2.875
	EVFELTP54HWR	82		54	2.875
	EVFELTP60HWR	90		60	2.875
	EVFELTP66HWR	99		66	2.875
	EVFELTP72HWR	112		72	2.875

**EVFELTXXYP - FELT TILE**

- Felt tile.
- Available in standard felt colors.
- Top trim with channel and PVC cap to be ordered separately.

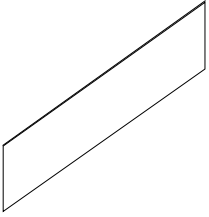
DESCRIPTION	PRODUCT CODE	LIST PRICE	DIMENSIONS/INCHES		
			H	W	D
 <p>Felt Tile - 6" High</p>	EVFELT0618P	34	6	18	
	EVFELT0624P	42	6	24	
	EVFELT0630P	58	6	30	
	EVFELT0636P	74	6	36	
	EVFELT0642P	91	6	42	
	EVFELT0648P	113	6	48	
	EVFELT0654P	128	6	54	
	EVFELT0660P	142	6	60	
	EVFELT0666P	160	6	66	
	EVFELT0672P	175	6	72	
<p>Felt Tile - 9" High</p>	EVFELT0918P	57	9	18	
	EVFELT0924P	69	9	24	
	EVFELT0930P	81	9	30	
	EVFELT0936P	98	9	36	
	EVFELT0942P	110	9	42	
	EVFELT0948P	181	9	48	
	EVFELT0954P	198	9	54	
	EVFELT0960P	217	9	60	
	EVFELT0966P	234	9	66	
	EVFELT0972P	248	9	72	

**EVPP - GLAZED FREESTANDING PRIVACY PANEL**

- Includes panel with two connectors with T legs.
- 3" thick freestanding panels with leveling glides.
- 22" deep T-legs for stability (9.5" on each side)
- All Modules are Tempered Glass.
- Includes end of run trim.

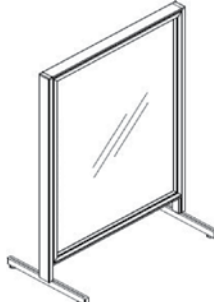
	DESCRIPTION	PRODUCT CODE	LIST PRICE		DIMENSIONS/INCHES		
			CLR	FRST ADD	H	W	D
	Glazed Monolithic Freestanding Privacy Panel	EVPPXGT5418	892	194	54	18	27/8
		EVPPXGT5424	984	228	54	24	27/8
		EVPPXGT5430	1069	265	54	30	27/8
		EVPPXGT5436	1151	299	54	36	27/8
		EVPPXGT5442	1243	336	54	42	27/8

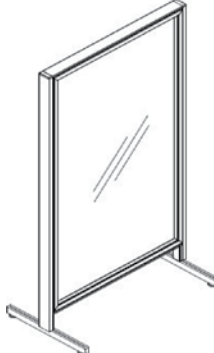
	DESCRIPTION	PRODUCT CODE	LIST PRICE		DIMENSIONS/INCHES		
			CLR	FRST ADD	H	W	D
	Glazed Monolithic Freestanding Privacy Panel	EVPPXGT6618	1028	234	66	18	27/8
		EVPPXGT6624	1128	273	66	24	27/8
		EVPPXGT6630	1231	312	66	30	27/8
		EVPPXGT6636	1324	350	66	36	27/8
		EVPPXGT6642	1434	395	66	42	27/8

**EVPP - GLAZED MOBILE PRIVACY PANEL**

- Includes panel with two connectors with T legs.
- 3" thick freestanding panels with 1" locking casters.
- 22" deep T-legs for stability (9.5" on each side)
- All Modules are Tempered Glass.
- Includes end of run trim.

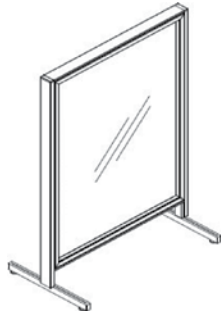
DESCRIPTION	PRODUCT CODE	LIST PRICE			DIMENSIONS/INCHES		
		CLR	FRST ADD	WRW ADD	H	W	D
 Mobile Glazed Monolithic Privacy Panel	EVPPXGT5418M	969	194	651	54	18	2 7/8
	EVPPXGT5424M	1058	232	806	54	24	2 7/8
	EVPPXGT5430M	1144	265	957	54	30	2 7/8
	EVPPXGT5436M	1227	299	1111	54	36	2 7/8
	EVPPXGT5442M	1319	335	1266	54	42	2 7/8

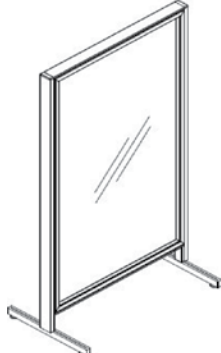
DESCRIPTION	PRODUCT CODE	LIST PRICE			DIMENSIONS/INCHES		
		CLR	FRST ADD	WRW ADD	H	W	D
 Mobile Glazed Monolithic Privacy Panel	EVPPXGT6618M	1102	234	801	66	18	2 7/8
	EVPPXGT6624M	1203	273	988	66	24	2 7/8
	EVPPXGT6630M	1305	313	1174	66	30	2 7/8
	EVPPXGT6636M	1399	351	1358	66	36	2 7/8
	EVPPXGT6642M	1509	395	1551	66	42	2 7/8

**EVPP - MONOLITHIC PRIVACY PANEL - RIBBED POLYCARBONATE**

- Includes panel with two connectors with T legs.
- 3" thick freestanding panels with leveling glides
- 22" deep T-legs for stability (9.5" on each side)
- Ribbed Panels are semi-private translucent polycarbonate.
- Includes end of run trim.

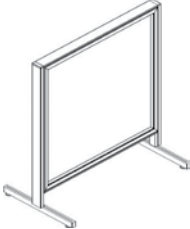
DESCRIPTION	PRODUCT CODE	LIST PRICE	DIMENSIONS/INCHES		
			H	W	D
 Freestanding Ribbed Monolithic Privacy Panel	EVPPXGR4218	815	42	18	2 7/8
	EVPPXGR4224	853	42	24	2 7/8
	EVPPXGR4230	929	42	30	2 7/8
	EVPPXGR4236	1005	42	36	2 7/8
	EVPPXGR4242	1083	42	42	2 7/8

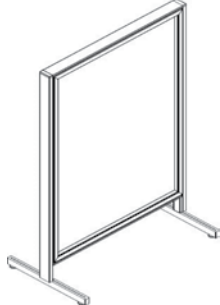
DESCRIPTION	PRODUCT CODE	LIST PRICE	DIMENSIONS/INCHES		
			H	W	D
 Freestanding Ribbed Monolithic Privacy Panel	EVPPXGR5418	954	54	18	2 7/8
	EVPPXGR5424	1013	54	24	2 7/8
	EVPPXGR5430	1100	54	30	2 7/8
	EVPPXGR5436	1189	54	36	2 7/8
	EVPPXGR5442	1286	54	42	2 7/8

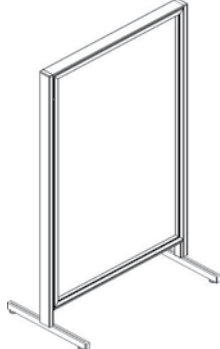
DESCRIPTION	PRODUCT CODE	LIST PRICE	DIMENSIONS/INCHES		
			H	W	D
 Freestanding Ribbed Monolithic Privacy Panel	EVPPXGR6618	1045	66	18	2 7/8
	EVPPXGR6624	1154	66	24	2 7/8
	EVPPXGR6630	1256	66	30	2 7/8
	EVPPXGR6636	1356	66	36	2 7/8
	EVPPXGR6642	1465	66	42	2 7/8

**EVPP - MONOLITHIC PRIVACY PANEL - RIBBED POLYCARBONATE**

- Includes panel with two connectors with T legs.
- 3" thick freestanding panels with 1" locking casters.
- 22" deep T-legs for stability (9.5" on each side)
- Ribbed Panels are semi-private translucent polycarbonate.
- Includes end of run trim.

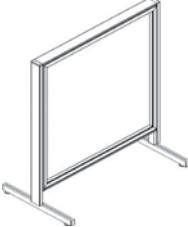
	DESCRIPTION	PRODUCT CODE	LIST PRICE	DIMENSIONS/INCHES		
				H	W	D
	Mobile Ribbed Monolithic Privacy Panel	EVPPXGR4218M	889	42	18	2 7/8
		EVPPXGR4224M	929	42	24	2 7/8
		EVPPXGR4230M	1005	42	30	2 7/8
		EVPPXGR4236M	1080	42	36	2 7/8
		EVPPXGR4242M	1158	42	42	2 7/8

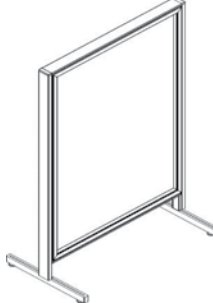
	DESCRIPTION	PRODUCT CODE	LIST PRICE	DIMENSIONS/INCHES		
				H	W	D
	Mobile Ribbed Monolithic Privacy Panel	EVPPXGR5418M	1033	54	18	2 7/8
		EVPPXGR5424M	1089	54	24	2 7/8
		EVPPXGR5430M	1177	54	30	2 7/8
		EVPPXGR5436M	1265	54	36	2 7/8
		EVPPXGR5442M	1362	54	42	2 7/8

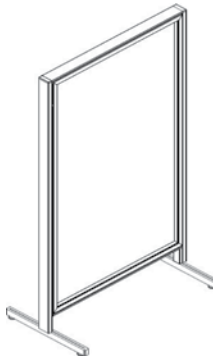
	DESCRIPTION	PRODUCT CODE	LIST PRICE	DIMENSIONS/INCHES		
				H	W	D
	Mobile Ribbed Monolithic Privacy Panel	EVPPXGR6618M	1121	66	18	2 7/8
		EVPPXGR6624M	1231	66	24	2 7/8
		EVPPXGR6630M	1256	66	30	2 7/8
		EVPPXGR6636M	1431	66	36	2 7/8
		EVPPXGR6642M	1539	66	42	2 7/8

**EVPP - MONOLITHIC PRIVACY PANEL - GLAZED**

- Includes panel with two connectors with T legs
- 3" thick freestanding panels with flat foot
- 22" deep T-legs for stability (9.5" on each side)
- Glazed Panels are available in tempered Clear glass (CLR) and Frosted glass (FRST)
- Includes end of run trim

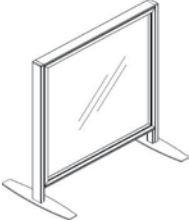
DESCRIPTION	PRODUCT CODE	LIST PRICE		DIMENSIONS/INCHES		
		CLR	FRST ADD	H	W	D
 Freestanding Glazed Monolithic Privacy Panel	EVPPXGTF4218	766	159	42	18	2 7/8
	EVPPXGTF4224	843	192	42	24	2 7/8
	EVPPXGTF4230	915	218	42	30	2 7/8
	EVPPXGTF4236	985	246	42	36	2 7/8
	EVPPXGTF4242	1064	279	42	42	2 7/8

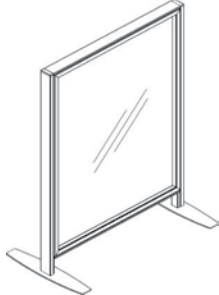
DESCRIPTION	PRODUCT CODE	LIST PRICE		DIMENSIONS/INCHES		
		CLR	FRST ADD	H	W	D
 Freestanding Glazed Monolithic Privacy Panel	EVPPXGTF5418	892	194	54	18	2 7/8
	EVPPXGTF5424	984	228	54	24	2 7/8
	EVPPXGTF5430	1069	265	54	30	2 7/8
	EVPPXGTF5436	1151	299	54	36	2 7/8
	EVPPXGTF5442	1243	299	54	42	2 7/8

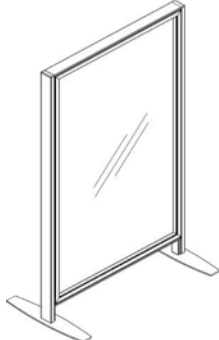
DESCRIPTION	PRODUCT CODE	LIST PRICE		DIMENSIONS/INCHES		
		CLR	FRST ADD	H	W	D
 Freestanding Glazed Monolithic Privacy Panel	EVPPXGTF6618	1028	234	66	18	2 7/8
	EVPPXGTF6624	1128	273	66	24	2 7/8
	EVPPXGTF6630	1231	312	66	30	2 7/8
	EVPPXGTF6636	1324	350	66	36	2 7/8
	EVPPXGTF6642	1434	394	66	42	2 7/8

**EVPP - MONOLITHIC PRIVACY PANEL - RIBBED POLYCARBONATE**

- Includes panel with two connectors with T legs
- 3" thick freestanding panels with flat foot
- 22" deep T-legs for stability (9.5" on each side)
- Ribbed Panels are semi-private translucent polycarbonate.
- Includes end of run trim.

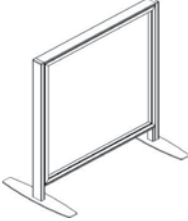
	DESCRIPTION	PRODUCT CODE	LIST PRICE	DIMENSIONS/INCHES		
				H	W	D
	Freestanding Ribbed Monolithic Privacy Panel	EVPPXGRF4218	815	42	18	2 7/8
		EVPPXGRF4224	853	42	24	2 7/8
		EVPPXGRF4230	929	42	30	2 7/8
		EVPPXGRF4236	1005	42	36	2 7/8
		EVPPXGRF4242	1083	42	42	2 7/8

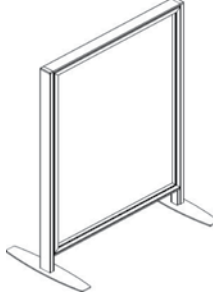
	DESCRIPTION	PRODUCT CODE	LIST PRICE	DIMENSIONS/INCHES		
				H	W	D
	Freestanding Ribbed Monolithic Privacy Panel	EVPPXGRF5418	954	54	18	2 7/8
		EVPPXGRF5424	1013	54	24	2 7/8
		EVPPXGRF5430	1100	54	30	2 7/8
		EVPPXGRF5436	1189	54	36	2 7/8
		EVPPXGRF5442	1286	54	42	2 7/8

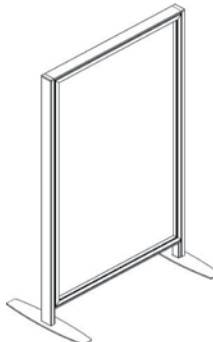
	DESCRIPTION	PRODUCT CODE	LIST PRICE	DIMENSIONS/INCHES		
				H	W	D
	Freestanding Ribbed Monolithic Privacy Panel	EVPPXGRF6618	1045	66	18	2 7/8
		EVPPXGRF6624	1154	66	24	2 7/8
		EVPPXGRF6630	1256	66	30	2 7/8
		EVPPXGRF6636	1356	66	36	2 7/8
		EVPPXGRF6642	1465	66	42	2 7/8

**EVPP - MONOLITHIC PRIVACY PANEL - 78" HIGH**

- Includes panel with two connectors with T legs.
- 3" thick freestanding panels with leveling glides
- 22" deep T-legs for stability (9.5" on each side)
- Glazed Panels are available in tempered Clear glass (CLR) and Frosted glass (FRST)
- Ribbed Panels are semi-private translucent polycarbonate.
- Includes end of run trim.
- Includes 48"H Glazed module and 29"H legs

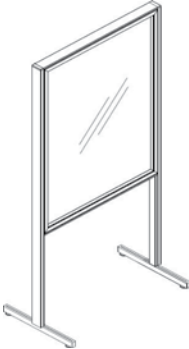
	DESCRIPTION	PRODUCT CODE	LIST PRICE		DIMENSIONS/INCHES		
			CLR	FRST ADD	H	W	D
	Freestanding Glazed Monolithic Privacy Panel	EVPPXGT7824	1053	232	78	24	2 7/8
		EVPPXGT7830	1138	265	78	30	2 7/8
		EVPPXGT7836	1222	299	78	36	2 7/8
		EVPPXGT7842	1316	335	78	42	2 7/8

**EVPP - MONOLITHIC PRIVACY PANEL - 78" HIGH**

- Includes panel with two connectors with T legs.
- 3" thick freestanding panels with leveling glides
- 22" deep T-legs for stability (9.5" on each side)
- Glazed Panels are available in tempered Clear glass (CLR) and Frosted glass (FRST)
- Ribbed Panels are semi-private translucent polycarbonate.
- Includes end of run trim.
- Includes 48"H Ribbled module and 29"H legs

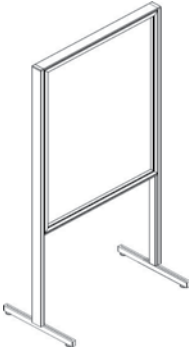
	DESCRIPTION	PRODUCT CODE	LIST PRICE	DIMENSIONS/INCHES		
				H	W	D
	Freestanding Ribbed Monolithic Privacy Panel	EVPPXGR7824	1092	78	24	2 7/8
		EVPPXGR7830	1182	78	30	2 7/8
		EVPPXGR7836	1092	78	36	2 7/8
		EVPPXGR7842	1366	78	42	2 7/8

**EVPP - MONOLITHIC PRIVACY PANEL - 78" HIGH**

- Includes panel with two connectors with T legs.
- 3" thick freestanding panels with 1" locking casters
- 22" deep T-legs for stability (9.5" on each side)
- Glazed Panels are available in tempered Clear glass (CLR) and Frosted glass (FRST)
- Ribbed Panels are semi-private translucent polycarbonate.
- Includes end of run trim.
- Includes 48"H Glazed module and 29"H legs

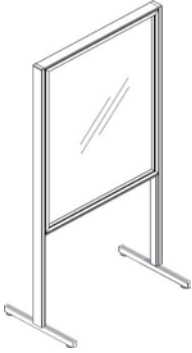
	DESCRIPTION	PRODUCT CODE	LIST PRICE		DIMENSIONS/INCHES		
			CLR	FRST ADD	H	W	D
	Mobile Glazed Monolithic Privacy Panel	EVPPXGT7824M	1129	228	78	24	27/8
		EVPPXGT7830M	1216	265	78	30	27/8
		EVPPXGT7836M	1298	299	78	36	27/8
		EVPPXGT7842M	1388	336	78	42	27/8

**EVPP - MONOLITHIC PRIVACY PANEL - 78" HIGH**

- Includes panel with two connectors with T legs.
- 3" thick freestanding panels with 1" locking casters
- 22" deep T-legs for stability (9.5" on each side)
- Glazed Panels are available in tempered Clear glass (CLR) and Frosted glass (FRST)
- Ribbed Panels are semi-private translucent polycarbonate.
- Includes end of run trim.
- Includes 48"H Ribbed module and 29"H legs

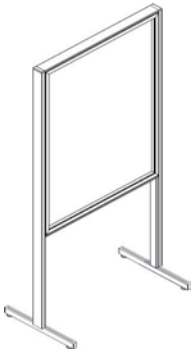
	DESCRIPTION	PRODUCT CODE	LIST PRICE	DIMENSIONS/INCHES		
				H	W	D
	Mobile Ribbed Monolithic Privacy Panel	EVPPXGR7824M	1169	78	24	27/8
		EVPPXGR7830M	1257	78	30	27/8
		EVPPXGR7836M	1169	78	36	27/8
		EVPPXGR7842M	1442	78	42	27/8

**EVPP - MONOLITHIC PRIVACY PANEL - 78" HIGH**

- Includes panel with two connectors with T legs
- 3" thick freestanding panels with flat foot
- 22" deep T-legs for stability (9.5" on each side)
- Glazed Panels are available in tempered Clear glass (CLR) and Frosted glass (FRST)
- Ribbed Panels are semi-private translucent polycarbonate.
- Includes end of run trim.
- Includes 48"H Glazed module and 29"H legs

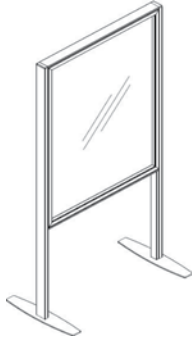

DESCRIPTION	PRODUCT CODE	LIST PRICE		DIMENSIONS/INCHES		
		CLR	FRST ADD	H	W	D
Freestanding Glazed Monolithic Privacy Panel	EVPPXGTF7824	1053	232	78	24	27/8
	EVPPXGTF7830	1138	265	78	30	27/8
	EVPPXGTF7836	1222	299	78	36	27/8
	EVPPXGTF7842	1316	335	78	42	27/8

**EVPP - MONOLITHIC PRIVACY PANEL - 78" HIGH**

- Includes panel with two connectors with T legs
- 3" thick freestanding panels with flat foot
- 22" deep T-legs for stability (9.5" on each side)
- Glazed Panels are available in tempered Clear glass (CLR) and Frosted glass (FRST)
- Ribbed Panels are semi-private translucent polycarbonate.
- Includes end of run trim.
- Includes 48"H Ribbed module and 29"H legs

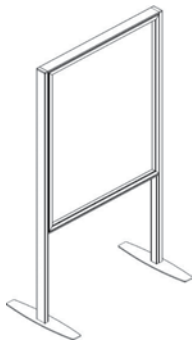

DESCRIPTION	PRODUCT CODE	LIST PRICE	DIMENSIONS/INCHES		
			H	W	D
Freestanding Ribbed Monolithic Privacy Panel	EVPPXGRF7824	1092	78	24	27/8
	EVPPXGRF7830	1182	78	30	27/8
	EVPPXGRF7836	1092	78	36	27/8
	EVPPXGRF7842	1366	78	42	27/8

**EVPP - GLAZED PRIVACY PANEL**

- Includes panel with two connectors with T legs.
- 3" thick freestanding panels with leveling glides
- 22" deep T-legs for stability (9.5" on each side)
- All Modules are Tempered Glass.
- Available in clear glass (CLR) and frosted glass (FRST)
- Includes end of run trim.

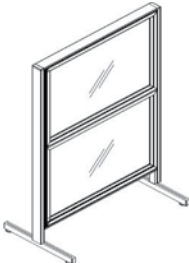
DESCRIPTION	PRODUCT CODE	LIST PRICE		DIMENSIONS/INCHES		
		CLR	FRST ADD	H	W	D
 Freestanding Glazed Privacy Panel	EVPPGT5424	1016	244	54	24	27/8
	EVPPGT5430	286	286	54	30	27/8
	EVPPGT5436	325	325	54	36	27/8
	EVPPGT5442	368	368	54	42	27/8
	EVPPGT5448	410	410	54	48	27/8
	EVPPGT5454	455	455	54	54	27/8
	EVPPGT5460	493	493	54	60	27/8

**EVPP - GLAZED PRIVACY PANEL**

- Includes panel with two connectors with T legs.
- 3" thick freestanding panels with leveling glides
- 22" deep T-legs for stability (9.5" on each side)
- All Modules are Tempered Glass.
- Available in clear glass (CLR) and frosted glass (FRST)
- Includes end of run trim.

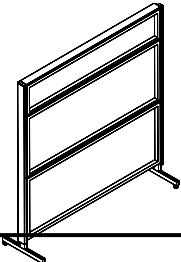
DESCRIPTION	PRODUCT CODE	LIST PRICE		DIMENSIONS/INCHES		
		CLR	FRST ADD	H	W	D
 Freestanding Glazed Privacy Panel	EVPPGT6624	1268	330	66	24	27/8
	EVPPGT6630	1391	384	66	30	27/8
	EVPPGT6636	1585	456	66	36	27/8
	EVPPGT6642	1719	511	66	42	27/8
	EVPPGT6648	1855	569	66	48	27/8
	EVPPGT6654	2007	629	66	54	27/8
	EVPPGT6660	2173	691	66	60	27/8

**EVPP - MOBILE GLAZED PRIVACY PANEL**

- Includes panel with two connectors with T legs.
- 3" thick freestanding panels with 1" locking casters.
- 22" deep T-legs for stability (9.5" on each side)
- All Modules are Tempered Glass.
- Available in clear glass (CLR) and frosted glass (FRST)
- Includes end of run trim.

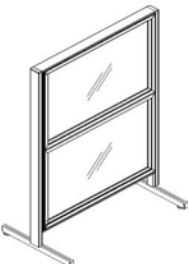
DESCRIPTION	PRODUCT CODE	LIST PRICE		DIMENSIONS/INCHES		
		CLR	FRST ADD	H	W	D
 Mobile Glazed Privacy Panel	EVPPGT5424M	1091	246	54	24	27/8
	EVPPGT5430M	1191	287	54	30	27/8
	EVPPGT5436M	1289	325	54	36	27/8
	EVPPGT5442M	1396	368	54	42	27/8
	EVPPGT5448M	1501	410	54	48	27/8
	EVPPGT5454M	1611	455	54	54	27/8
	EVPPGT5460M	1707	493	54	60	27/8

**EVPP - MOBILE GLAZED PRIVACY PANEL**

- Includes panel with two connectors with T legs.
- 3" thick freestanding panels with 1" locking casters.
- 22" deep T-legs for stability (9.5" on each side)
- All Modules are Tempered Glass.
- Available in clear glass (CLR) and frosted glass (FRST)
- Includes end of run trim.

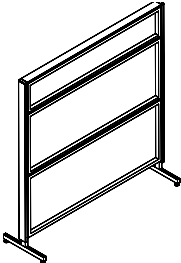
	DESCRIPTION	PRODUCT CODE	LIST PRICE		DIMENSIONS/INCHES		
			CLR	FRST ADD	H	W	D
	Mobile Glazed Privacy Panel	EVPPGT6624M	1344	332	66	24	27/8
		EVPPGT6630M	1467	381	66	30	27/8
		EVPPGT6636M	1659	456	66	36	27/8
		EVPPGT6642M	1795	511	66	42	27/8
		EVPPGT6648M	1930	569	66	48	27/8
		EVPPGT6654M	2083	624	66	54	27/8
		EVPPGT6660M	2245	692	66	60	27/8

**EVPP - LAMINATE GLAZED PRIVACY PANEL**

- Includes panel with two connectors with T legs.
- 3" thick freestanding panels with leveling glides
- 22" deep T-legs for stability (9.5" on each side)
- All Modules are Tempered Glass.
- Bottom Two Modules are Laminate w/12" Tempered Glass on top.
- Includes end of run trim.

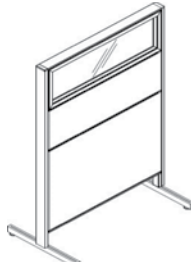
	DESCRIPTION	PRODUCT CODE	LIST PRICE		DIMENSIONS/INCHES		
			CLR	FRST ADD	H	W	D
	Freestanding Laminate Glazed Privacy Panel	EVPPHGTU5424	1240	170	54	24	27/8
		EVPPHGTU5430	1375	196	54	30	27/8
		EVPPHGTU5436	1513	226	54	36	27/8
		EVPPHGTU5442	1650	253	54	42	27/8
		EVPPHGTU5448	1787	279	54	48	27/8
		EVPPHGTU5454	1938	310	54	54	27/8
		EVPPHGTU5460	2077	336	54	60	27/8

**EVPP - LAMINATE GLAZED PRIVACY PANEL**

- Includes panel with two connectors with T legs.
- 3" thick freestanding panels with leveling glides
- 22" deep T-legs for stability (9.5" on each side)
- Bottom Two Modules are Laminate w/12" Tempered Glass on top.
- Includes end of run trim.

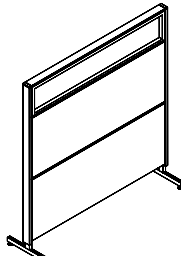
	DESCRIPTION	PRODUCT CODE	LIST PRICE		DIMENSIONS/INCHES		
			CLR	FRST ADD	H	W	D
	Freestanding Laminate Glazed Privacy Panel	EVPPHGTU6624	1386	193	66	24	27/8
		EVPPHGTU6630	1548	224	66	30	27/8
		EVPPHGTU6636	1740	264	66	36	27/8
		EVPPHGTU6642	1899	292	66	42	27/8
		EVPPHGTU6648	2055	326	66	48	27/8
		EVPPHGTU6654	2235	361	66	54	27/8
		EVPPHGTU6660	2430	399	66	60	27/8

**EVPP - MOBILE LAMINATE GLAZED PRIVACY PANEL**

- Includes panel with two connectors with T legs.
- 3" thick freestanding panels with 1" locking casters.
- 22" deep T-legs for stability (9.5" on each side)
- Bottom Two Modules are Laminate w/12" Tempered Glass on top.
- Includes end of run trim.

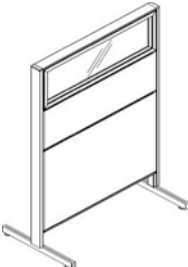
DESCRIPTION	PRODUCT CODE	LIST PRICE		DIMENSIONS/INCHES		
		CLR	FRST ADD	H	W	D
 <p>Mobile Laminate Glazed Privacy Panel</p>	EVPPHGTU5424M	1316	170	54	24	27/8
	EVPPHGTU5430M	1450	196	54	30	27/8
	EVPPHGTU5436M	1589	224	54	36	27/8
	EVPPHGTU5442M	1729	253	54	42	27/8
	EVPPHGTU5448M	1863	280	54	48	27/8
	EVPPHGTU5454M	2012	311	54	54	27/8
	EVPPHGTU5460M	2152	338	54	60	27/8

**EVPP - MOBILE LAMINATE GLAZED PRIVACY PANEL**

- Includes panel with two connectors with T legs.
- 3" thick freestanding panels with 1" locking casters.
- 22" deep T-legs for stability (9.5" on each side)
- Bottom Two Modules are Laminate w/12" Tempered Glass on top.
- Includes end of run trim.

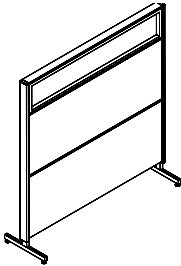
DESCRIPTION	PRODUCT CODE	LIST PRICE		DIMENSIONS/INCHES		
		CLR	FRST ADD	H	W	D
 <p>Mobile Laminate Glazed Privacy Panel</p>	EVPPHGTU6624M	1462	193	66	24	27/8
	EVPPHGTU6630M	1623	222	66	30	27/8
	EVPPHGTU6636M	1816	265	66	36	27/8
	EVPPHGTU6642M	1974	290	66	42	27/8
	EVPPHGTU6648M	2133	325	66	48	27/8
	EVPPHGTU6654M	2310	361	66	54	27/8
	EVPPHGTU6660M	2505	399	66	60	27/8

**EVPP - LAMINATE GLAZED PRIVACY PANEL**

- Includes panel with two connectors with T legs.
- 3" thick freestanding panels with leveling glides
- 22" deep T-legs for stability (9.5" on each side)
- All Modules are Tempered Glass.
- Laminate Base Module w/24" Tempered Glass above.
- Includes end of run trim.

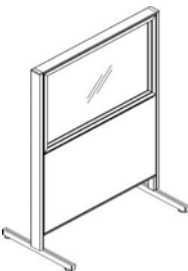
DESCRIPTION	PRODUCT CODE	LIST PRICE		DIMENSIONS/INCHES		
		CLR	FRST ADD	H	W	D
 <p>Freestanding Laminate Glazed Privacy Panel</p>	EVPPHGT5424	1074	136	54	24	27/8
	EVPPHGT5430	1192	161	54	30	27/8
	EVPPHGT5436	1316	182	54	36	27/8
	EVPPHGT5442	1435	207	54	42	27/8
	EVPPHGT5448	1552	234	54	48	27/8
	EVPPHGT5454	1680	257	54	54	27/8
	EVPPHGT5460	1794	281	54	60	27/8

**EVPP - LAMINATE GLAZED PRIVACY PANEL**

- Includes panel with two connectors with T legs.
- 3" thick freestanding panels with leveling glides
- 22" deep T-legs for stability (9.5" on each side)
- Laminate Base Module w/36" Tempered Glass above.
- Includes end of run trim.

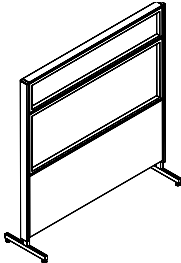
	DESCRIPTION	PRODUCT CODE	LIST PRICE		DIMENSIONS/INCHES		
			CLR	FRST ADD	H	W	D
	Freestanding Laminate Glazed Privacy Panel	EVPPHGT6624	1328	179	66	24	27/8
		EVPPHGT6630	1471	207	66	30	27/8
		EVPPHGT6636	1656	246	66	36	27/8
		EVPPHGT6642	1796	273	66	42	27/8
		EVPPHGT6648	1941	302	66	48	27/8
		EVPPHGT6654	2107	336	66	54	27/8
		EVPPHGT6660	2300	373	66	60	27/8

**EVPP - MOBILE LAMINATE GLAZED PRIVACY PANEL**

- Includes panel with two connectors with T legs.
- 3" thick freestanding panels with 1" locking casters.
- 22" deep T-legs for stability (9.5" on each side)
- Laminate Base Module w/36" Tempered Glass above.
- Includes end of run trim.

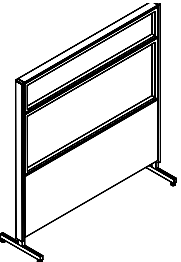
	DESCRIPTION	PRODUCT CODE	LIST PRICE		DIMENSIONS/INCHES		
			CLR	FRST ADD	H	W	D
	Mobile Laminate Glazed Privacy Panel	EVPPHGT6624M	1404	180	66	24	27/8
		EVPPHGT6630M	1547	206	66	30	27/8
		EVPPHGT6636M	1733	246	66	36	27/8
		EVPPHGT6642M	1871	273	66	42	27/8
		EVPPHGT6648M	2017	301	66	48	27/8
		EVPPHGT6654M	2183	335	66	54	27/8
		EVPPHGT6660M	2376	373	66	60	27/8

**EVPP - MOBILE LAMINATE GLAZED PRIVACY PANEL**

- Includes panel with two connectors with T legs.
- 3" thick freestanding panels with 1" locking casters.
- 22" deep T-legs for stability (9.5" on each side)
- Laminate Base Module w/24" Tempered Glass above.
- Includes end of run trim.

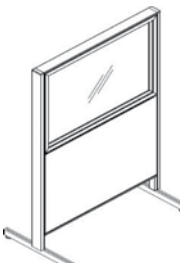
	DESCRIPTION	PRODUCT CODE	LIST PRICE		DIMENSIONS/INCHES		
			CLR	FRST ADD	H	W	D
	Mobile Laminate Glazed Privacy Panel	EVPPHGT5424M	1149	137	54	24	27/8
		EVPPHGT5430M	1267	161	54	30	27/8
		EVPPHGT5436M	1388	183	54	36	27/8
		EVPPHGT5442M	1511	210	54	42	27/8
		EVPPHGT5448M	1630	233	54	48	27/8
		EVPPHGT5454M	1756	257	54	54	27/8
		EVPPHGT5460M	1869	280	54	60	27/8

**EVPP - LAMINATE PRIVACY PANEL**

- Includes panel with two connectors with T legs.
- 3" thick freestanding panels with leveling glides
- 22" deep T-legs for stability (9.5" on each side)
- All Modules are Laminate.
- Includes end of run trim.

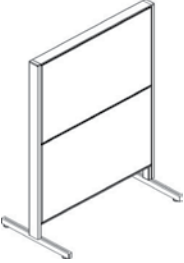
DESCRIPTION	PRODUCT CODE	LIST PRICE	DIMENSIONS/INCHES		
			H	W	D
 Freestanding Laminate Privacy Panel	EVPPH2S5424	1133	54	24	27/8
	EVPPH2S5430	1271	54	30	27/8
	EVPPH2S5436	1417	54	36	27/8
	EVPPH2S5442	1550	54	42	27/8
	EVPPH2S5448	1680	54	48	27/8
	EVPPH2S5454	1825	54	54	27/8
	EVPPH2S5460	1954	54	60	27/8

**EVPP - LAMINATE PRIVACY PANEL**

- Includes panel with two connectors with T legs.
- 3" thick freestanding panels with leveling glides
- 22" deep T-legs for stability (9.5" on each side)
- All Modules are Laminate.
- Includes end of run trim.

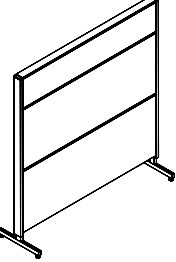
DESCRIPTION	PRODUCT CODE	LIST PRICE	DIMENSIONS/INCHES		
			H	W	D
 Freestanding Laminate Privacy Panel	EVPPH2S6624	1371	66	24	27/8
	EVPPH2S6630	1549	66	30	27/8
	EVPPH2S6636	1752	66	36	27/8
	EVPPH2S6642	1928	66	42	27/8
	EVPPH2S6648	2098	66	48	27/8
	EVPPH2S6654	2275	66	54	27/8
	EVPPH2S6660	2463	66	60	27/8

**EVPP - MOBILE LAMINATE PRIVACY PANEL**

- Includes panel with two connectors with T legs.
- 3" thick freestanding panels with 1" locking casters.
- 22" deep T-legs for stability (9.5" on each side)
- All Modules are Laminate.
- Available in clear glass (CLR) and frosted glass (FRST)
- Includes end of run trim.

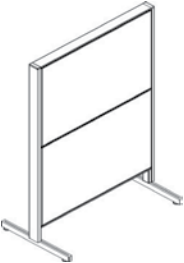
DESCRIPTION	PRODUCT CODE	LIST PRICE	DIMENSIONS/INCHES		
			H	W	D
 Mobile Laminate Privacy Panel	EVPPH2S5424M	1206	54	24	27/8
	EVPPH2S5430M	1345	54	30	27/8
	EVPPH2S5436M	1491	54	36	27/8
	EVPPH2S5442M	1627	54	42	27/8
	EVPPH2S5448M	1756	54	48	27/8
	EVPPH2S5454M	1900	54	54	27/8
	EVPPH2S5460M	2031	54	60	27/8

**EVPP - MOBILE LAMINATE PRIVACY PANEL**

- Includes panel with two connectors with T legs.
- 3" thick freestanding panels with 1" locking casters.
- 22" deep T-legs for stability (9.5" on each side)
- All Modules are Laminate.
- Includes end of run trim.

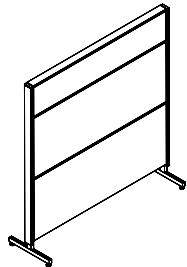

DESCRIPTION	PRODUCT CODE	LIST PRICE	DIMENSIONS/INCHES		
			H	W	D
Mobile Laminate Privacy Panel	EVPPH2S6624M	1446	66	24	2 7/8
	EVPPH2S6630M	1625	66	30	2 7/8
	EVPPH2S6636M	1828	66	36	2 7/8
	EVPPH2S6642M	2004	66	42	2 7/8
	EVPPH2S6648M	2174	66	48	2 7/8
	EVPPH2S6654M	2350	66	54	2 7/8
	EVPPH2S6660M	2537	66	60	2 7/8

**EVPP - FABRIC WRITE BOARD PRIVACY PANEL**

- Includes panel with two connectors with T legs.
- 3" thick freestanding panels with leveling glides
- 22" deep T-legs for stability (9.5" on each side)
- Fabric Base Module with Write Board above.
- Includes end of run trim.

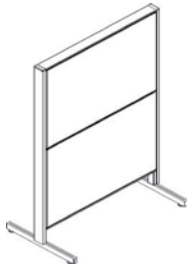

DESCRIPTION	PRODUCT CODE	LIST PRICE		DIMENSIONS/INCHES		
		GR 1	GR 2	H	W	D
Freestanding Write Board Privacy Panel	EVPPF2W5424	1093	1114	54	24	2 7/8
	EVPPF2W5430	1224	1251	54	30	2 7/8
	EVPPF2W5436	1354	1388	54	36	2 7/8
	EVPPF2W5442	1486	1519	54	42	2 7/8
	EVPPF2W5448	1634	1675	54	48	2 7/8
	EVPPF2W5454	1776	1823	54	54	2 7/8
	EVPPF2W5460	1902	1955	54	60	2 7/8

**EVPP - MOBILE FABRIC WRITE BOARD PRIVACY PANEL**

- Includes panel with two connectors with T legs.
- 3" thick freestanding panels with 1" locking casters.
- 22" deep T-legs for stability (9.5" on each side)
- Fabric Base Module with Write Board above.
- Includes end of run trim.

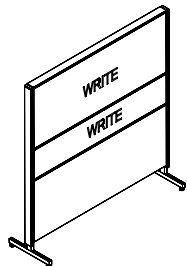

DESCRIPTION	PRODUCT CODE	LIST PRICE		DIMENSIONS/INCHES		
		GR 1	GR 2	H	W	D
Mobile Write Board Glazed Privacy Panel	EVPPF2W6624M	1396	1419	66	24	2 7/8
	EVPPF2W6630M	1623	1651	66	30	2 7/8
	EVPPF2W6636M	1821	1850	66	36	2 7/8
	EVPPF2W6642M	2000	2038	66	42	2 7/8
	EVPPF2W6648M	2198	2237	66	48	2 7/8
	EVPPF2W6654M	2382	2435	66	54	2 7/8
	EVPPF2W6660M	2611	2659	66	60	2 7/8

**EVPP - MOBILE FABRIC WRITE BOARD PRIVACY PANEL**

- Includes panel with two connectors with T legs.
- 3" thick freestanding panels with 1" locking casters.
- 22" deep T-legs for stability (9.5" on each side)
- Fabric Base Module with Write Board above.
- Includes end of run trim.

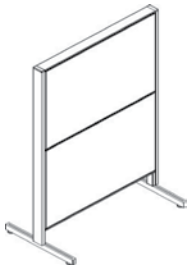
DESCRIPTION	PRODUCT CODE	LIST PRICE		DIMENSIONS/INCHES		
		GR 1	GR 2	H	W	D
 <p>Mobile Write Board Privacy Panel</p>	EVPPF2W5424M	1170	1190	54	24	27/8
	EVPPF2W5430M	1299	1327	54	30	27/8
	EVPPF2W5436M	1430	1463	54	36	27/8
	EVPPF2W5442M	1559	1594	54	42	27/8
	EVPPF2W5448M	1710	1751	54	48	27/8
	EVPPF2W5454M	1851	1898	54	54	27/8
	EVPPF2W5460M	1978	2031	54	60	27/8

**EVPP - MOBILE LAMINATE WRITE BOARD PRIVACY PANEL**

- Includes panel with two connectors with T legs.
- 3" thick freestanding panels with 1" locking casters.
- 22" deep T-legs for stability (9.5" on each side)
- Laminate Base Module with Write Board above.
- Includes end of run trim.

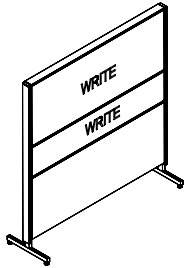
DESCRIPTION	PRODUCT CODE	LIST PRICE	DIMENSIONS/INCHES		
			H	W	D
 <p>Mobile Write Board Laminate Privacy Panel</p>	EVPPH2W6624M	1493	66	24	27/8
	EVPPH2W6630M	1754	66	30	27/8
	EVPPH2W6636M	1993	66	36	27/8
	EVPPH2W6642M	2188	66	42	27/8
	EVPPH2W6648M	2384	66	48	27/8
	EVPPH2W6654M	2590	66	54	27/8
	EVPPH2W6660M	2799	66	60	27/8

**EVPP - LAMINATE WRITE BOARD PRIVACY PANEL**

- Includes panel with two connectors with T legs.
- 3" thick freestanding panels with leveling glides
- 22" deep T-legs for stability (9.5" on each side)
- Laminate Base Module with Write Board above.
- Includes end of run trim.

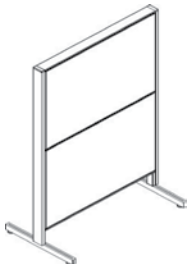
DESCRIPTION	PRODUCT CODE	LIST PRICE	DIMENSIONS/INCHES		
			H	W	D
 <p>Freestanding Write Board Privacy Panel</p>	EVPPH2W5424	1200	54	24	27/8
	EVPPH2W5430	1357	54	30	27/8
	EVPPH2W5436	1522	54	36	27/8
	EVPPH2W5442	1674	54	42	27/8
	EVPPH2W5448	1821	54	48	27/8
	EVPPH2W5454	1982	54	54	27/8
	EVPPH2W5460	2129	54	60	27/8

**EVPP - LAMINATE WRITE BOARD PRIVACY PANEL**

- Includes panel with two connectors with T legs.
- 3" thick freestanding panels with leveling glides
- 22" deep T-legs for stability (9.5" on each side)
- Laminate Base Module with Write Board above
- Includes end of run trim.

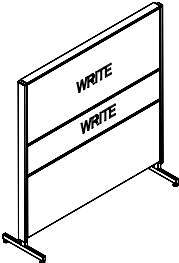
DESCRIPTION	PRODUCT CODE	LIST PRICE	DIMENSIONS/INCHES		
			H	W	D
 Freestanding Write Board Laminate Privacy Panel	EVPPH2W6624	1419	66	24	2 7/8
	EVPPH2W6630	1679	66	30	2 7/8
	EVPPH2W6636	1918	66	36	2 7/8
	EVPPH2W6642	2112	66	42	2 7/8
	EVPPH2W6648	2307	66	48	2 7/8
	EVPPH2W6654	2514	66	54	2 7/8
	EVPPH2W6660	2725	66	60	2 7/8

**EVPP - MOBILE LAMINATE WRITE BOARD PRIVACY PANEL**

- Includes panel with two connectors with T legs.
- 3" thick freestanding panels with 1" locking casters.
- 22" deep T-legs for stability (9.5" on each side)
- Laminate Base Module with Write Board above.
- Includes end of run trim.

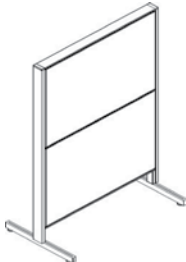
DESCRIPTION	PRODUCT CODE	LIST PRICE	DIMENSIONS/INCHES		
			H	W	D
 Mobile Write Board Privacy Panel	EVPPH2W5424M	1277	54	24	2 7/8
	EVPPH2W5430M	1434	54	30	2 7/8
	EVPPH2W5436M	1595	54	36	2 7/8
	EVPPH2W5442M	1747	54	42	2 7/8
	EVPPH2W5448M	1895	54	48	2 7/8
	EVPPH2W5454M	2057	54	54	2 7/8
	EVPPH2W5460M	2205	54	60	2 7/8

**EVPP - FABRIC WRITE BOARD PRIVACY PANEL**

- Includes panel with two connectors with T legs.
- 3" thick freestanding panels with leveling glides
- 22" deep T-legs for stability (9.5" on each side)
- Fabric Base Module with Write Board above
- Includes end of run trim.

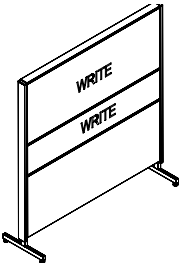
DESCRIPTION	PRODUCT CODE	LIST PRICE		DIMENSIONS/INCHES		
		GR 1	GR 2	H	W	D
 Freestanding Write Board Glazed Privacy Panel	EVPPF2W6624	1321	1342	66	24	2 7/8
	EVPPF2W6630	1548	1577	66	30	2 7/8
	EVPPF2W6636	1745	1775	66	36	2 7/8
	EVPPF2W6642	1925	1960	66	42	2 7/8
	EVPPF2W6648	2124	2159	66	48	2 7/8
	EVPPF2W6654	2305	2358	66	54	2 7/8
	EVPPF2W6660	2536	2584	66	60	2 7/8