

compile quick ship



compile systems quickship program



PROTECTING THE ENVIRONMENT FOR FUTURE GENERATIONS

Our environmental success story began with the challenge to create an office system that would meet today's business requirements while maintaining a firm commitment to save and protect the environment.

Sustainability became a part of the creative focus and development of Compile that incorporates the latest technology and design features to provide excellent performance at a competitive price.

As government and industry environment ratings such as LEEDS & Greenguard become more prevalent, Compile offers designers and architects functional, attractive, and economical office designs that meet these standards.

Evolve Furniture Group is a leader in reducing waste in the manufacturing of its products as well as utilizing recycled materials wherever possible. We make extensive use of recycled plastic and wood waste from other Global factories.

Evolve Furniture Group is committed to the continuous improvement of our environmental systems, the prevention of pollution, and to comply with both the spirit and the letter of all relevant environmental legislation.

Compile Panels are 100% recyclable at the end of their lifespan. Nothing from an Evolve Panel needs to end up in a landfill.

SUSTAINABILITY INFORMATION

Compile offers fabrics that are made from 100% recycled polyester, which means less waste going to landfills. These fabrics also reduced the demand for petroleum products, and decrease the environmental impacts of processing those petroleum products into polyester.

Compile's epoxy powder coating process involves no liquids and is solvent free. It contains no harmful VOC's or lead. Up to 99% of over sprayed powdered is reclaimed, mixed with virgin powder and reused.

Compile's entire panel is up to 82% recycled.

Compile masonite is up to 85% recycled.

Compile's entire product line is up to 99% recyclable.

COMPILE SYSTEMS

As your business grows, Compile adapts to changes within your workplace and grows with you. Compile’s simplicity and flexibility aim to keep your long-term costs low. It’s the affordable furniture solution to complete your office environment today AND tomorrow without sacrificing quality or beauty.

SIMPLY SIMPLE

Compile panels and universal corner posts ship with pre-assembled “Quick Connect”, which makes it one of the easiest system products to install and reconfigure. Aluminum raceway covers hinge upward and lock in place or can be easily removed providing open access and better protection for power and data in the base of the panel.

SIMPLY CLEAN

The Compile system offers a clean appearance from top to bottom. Quick Ship panels are available in a clean monolithic appearance and utilize aluminum raceway covers that are available with or without knockouts. An innovative worksurface support and overhead storage mounting system eliminates the need for slots in the panel frames, providing a softer visual appearance.

SIMPLY QUICK

Compile’s Quick ship program offers a carefully curated collection of pieces that deliver maximum functionality and value, are easy to specify and install and ship within 10 manufacturing days. Blend Compile panels with Offices to Go height adjustable bases, monitor arms and seating for an even wider array of Quick Ship planning solutions.

Ideal for workplace, education and healthcare environments, Compile can create a range of planning applications in a curated palette of textiles and finishes.

QUICK SHIP LEAD TIMES

Orders will be manufactured and shipped 10 Business Days after receipt of clean order. This excludes shipping and delivery which vary based on location. Processing of all orders will begin the following business day. No exceptions.

ORDERING PROCESS

- Orders must be placed electronically via SP4 or SIF file
- Email orders with SP4 or SIF file to: Orders-CompileQS@Globalfurnituregroup.com
- Compile Quick Ship orders must be ordered separately from Non-Compile Quick Ship orders
- Purchase orders must clearly indicate “Quick Ship” in the subject line
- If applicable, Special Pricing Quote # must be indicated on order
- End user name and installation address MUST be included on order
- Salesperson KEY CODES must be included

ORDER CHANGES AND CANCELLATIONS

Once an order has been placed, it cannot be changed or canceled. No Exceptions.

ORDER LIMITS

The maximum Quick Ship order limit is \$150,000 list or 40 workstations Orders exceeding these quantities are subject to standard lead times.

FREIGHT

Free freight applies to orders dock delivered to one commercial business location in the contiguous United States during normal business hours. Residential deliveries will incur additional delivery charges.

REFERENCES

Features, Benefits & General Information 3
 Coding an Order 4
 Textiles & Finishes 52
 Terms & Conditions 53

PANELS

Panels – Technical Information 8
 Panel – Types 9
 Panel Package – Configuration 11
 Monolithic Panel Packages 12
 Over Panels 14
 Gallery Panels 16
 Post Packages 21
 Posts & Trim Inserts 22
 Raceway & Knockout Covers 23
 Post Covers 25

ELECTRICAL

Electrical – Technical Information 27
 Electrical – Wire Schematic 28
 Electrical – Configuration 29
 Power Distribution Housing 30
 Cables 31
 I Connector 31
 Duplex Receptacle 32
 Power Entry 33
 Electrical Box 33
 Post Extension 34
 Ceiling Feed 34
 Cable Cover 34
 Task Lights 35

WORKSURFACES

Worksurfaces – Technical Information 37
 Worksurfaces – Configuration 38
 Rectangular Worksurface 39
 Corner Worksurface 40
 Rectangular Worksurface for Height Adjustable Bases 41
 Accessories 41

STORAGE

Storage – Technical Information 47
 Storage – Configuration 48
 Pedestals 49
 Overhead Storage 50
 Lateral File 51



PANELS

- Panel Fabric modules consist of Module Frames, Module Interiors and Fabric Skins.

Fabric

- Fabric offerings include selections woven with 100% recycled yarn.

Panel Frame

- Typical workstation contains up to 62.2% recycled material.
- Panel is made of 82.3% recycled material.
- Acoustic panels are light tackable with 0.70 NRC and a 26 STC rating.
- Non Acoustic panels are not tackable with 0.17 NRC and a 28 STC rating.
- Raceway covers are aluminum.
- Plastic top cap vs Aluminum top cap.

Metal Components/Raceway Finish

- All aluminum components are painted with environmentally friendly epoxy powder.
- Raceway interiors are coated with recycled epoxy powder.
- The entire Compile Panel and the processes used to manufacture it are designed to save and protect the environment. Compile Panels are made from recycled materials and are 99% recyclable.

Panel Options

- Compile Panels come in 4 heights: 42", 54" and 66".
- Panel widths come in 7 sizes including: 24", 30", 36", 42", 48", 54" and 60".
- Panels conform to CGSB and ANSI/BIFMA standards. - This is your assurance that the quality, and performance level of these Panels have been tested to equal or exceed the requirements of the US government.
- Rigid, aluminum Panel Frame is 2 3/8" thick.
- Aluminum Panel Frame combined with easy to assemble "Quick Connect" clips, create a rigid Panel Wall.
- Levelling glides extend 2". Enables the client to deal with severe undulations in the flooring levels of a building.
- Compile makes it easy to select a Panel function that is suitable for your application.
- Compile makes it easy to select a Panel type and height that is suitable for your application.

VOICE/DATA AND ELECTRICAL POWER

- Voice/data cables can be inserted at the base. 8 wire, 4 circuit electrical capability, 2 utility + 2 dedicated circuits, each with 10 gauge (oversized) neutrals. All circuits can support up to 20 amps (15 CSA).
- Raceway Cover opening sizes conform to the ANSI/TIA/EIA Furniture Opening Standard of 1.345" x 2.680".
- Panels 24" wide include raceway covers with 2 knockouts.
- Panels 30" – 60" wide include raceway covers with 3 knockouts.
- Panels and electrical components are CSA/UL

approved.

- Compile panel raceway is roughly 2.13" x 4.6" without power distribution housing installed. With power distribution housing installed inside, the dimension is reduced to roughly 2.13" x 2.13
- The base raceway cavity accommodates 50 .25" diameter communication cables without power installed or 30 .25" diameter communication cables with power installed.
- 90-degree posts accommodate 25 .25" diameter communication cables without a ceiling infeed or 20 .25" diameter communication cables with a ceiling infeed installed.
- 120-degree posts may not be utilized for power infeeds or communication cables. 90-degree posts may be utilized at the end of a 120-degree configuration if ceiling infeed of power and/or data cables is required.
- No tools are required to install electrical in the Compile Panel System.

WORKSURFACES

- 1" thick worksurfaces come in a variety of shapes and sizes. Essentially, they are 24" or 30" deep and are available in 6" increments from 24" to 84" wide.
- Cable scoops located at the back of each Worksurface provide routing of power and data cables.
- This convenient feature, together with a 3/8" gap between the Worksurface and the Panel, allows access to cables without having grommet holes in the Worksurface.
- With this choice of product, we can tailor each installation to your requirements. The addition of custom sizes shows a commitment to client satisfaction that not every manufacturer offers.
- Thermally fused laminate tops are standard.
- All Worksurfaces utilize balanced construction.
- Predrilled holes in worksurfaces enable installer to properly align worksurface.

STORAGE

- 22 5/8" deep Pedestals. Freestanding and Worksurface supporting options available.
- Drawer divider and pencil tray included in all Freestanding Pedestals containing box drawers. Drawer divider and pencil tray not included in Worksurface Supporting Pedestals.
- Adjustable glides are accessible from the inside of the cabinet.
- Positive and secure locking system on all Pedestals is standard.
- Full height drawer sides are standard on all file drawers. This enables you to hang files from the drawer side so no extra hardware is necessary. File drawers accept letter sized files. Optional file bars are available to file legal and metric sized files.
- Steel construction guarantees the performance of the product over the long term. Welded joints with a full top, back and base ensure that the Pedestal will sit square and adequately support the Worksurface where necessary.
- Worksurface supporting Pedestals are standard with

Compile.

- Shelves feature all metal construction.
- All storage components as well as the Panel Frames are epoxy powder coated.
- Glides enable you to level the cabinet to the floor and or Worksurface. The convenient adjustment feature allows the installer to adjust the height of the cabinet while it is under the Worksurface. This saves time in the installation process.
- For additional security and peace of mind, locks can be keyed alike or master keyed for additional convenience. Standard recessed handle offers uncluttered aesthetic.
- "Environmentally friendly" epoxy powder coat is 15 times more durable in independent testing than a wet paint spray. This helps maintain the look of the product over its many years of service.

WARRANTIES AND PERFORMANCE

- A Lifetime Warranty
- Non Obsolescence Warranty
- Reduced cost of assembly and reconfiguration
- ISO9001:2008 Registered
- ISO14001:2004 Registered
- GreenGuard Certified
- Level 2 Certified
- ANSI/BIFMA CGSB testing on all products
- For piece of mind over the long term, we cover you with a comprehensive warranty that is supported by our dealer network.
- Some installation companies claim that the Compile Panels System can be installed in half the time it takes to install most of our competitor's segmented panels. This cost saving can amount to thousands of dollars over the lifetime of our furniture.
- Your assurance of consistent quality to an international standard. Evolve Furniture Group is committed to design, manufacture and distribute superior quality office furniture, which meets or exceeds the requirements of our customers.
- Confirmation that Evolve Furniture Group is committed (1) to providing product that, through their entire life cycle, minimize negative environmental impacts on the environment, (2) to continuous improvement to our environmental systems and programs and (3) to comply to all relevant environmental legislation and regulations.
- Compile Panel System can help a company meet LEED requirements for office furniture.
- Compile components are tested to the highest standard in the industry. This is your assurance of quality and longevity.
- Panel textiles, adjustable keyboard mechanisms, task lights and electrical devices = five (5) Years
- Other parts = Lifetime Warranty

Compile products have been coded using alphas that correspond with the product name. This creates an easy-to-remember code. The following breaks down the coding logic and highlights the required code components needed to order within each product category.

Panels

Example: **Product:** Compile Fabric Monolithic Panel

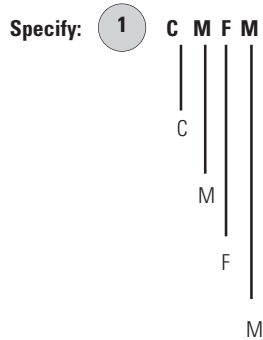

Base Code found on the product page to the left of the product name and a simple product illustration.

CoMpile product line

Fabric-covered Panel

Monolithic panel category

2 CMFM**6648**

Panel size offering. Listed on every product page with price listing.

Note: Additional dimensions are provided for most products on the far right hand side of each page. These dimensions are not required in the ordering code.

3 CMFM6648-**BK**

Standard paint code for frame. See the Fabric & Finish listing in this section.

To specify fabric for a Compile Panel, please note:

4 CMFM6648-BK-**B84A**

Fabric code for all modules on both sides of the Panel*. See the Fabric & Finish listing in this section.

* **NOTE:** If different fabrics are to be included on a Compile Panel, please use the following ordering format. **Start at the bottom** of one side of a Panel and work to the top module of that Panel. Then start the process over on the other side of the Panel. As an example:

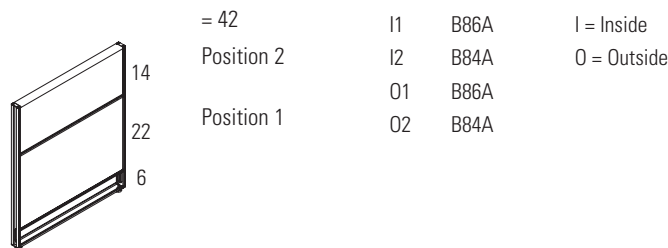

Electrical

Example: **Product:** Flexible Mesh Jumper Cable

Specify: **1** **C E 8 C P 1 7**



2 CE8CP17

Base Code found on the product page to the left of the product name and a simple product illustration.

Compile product line.

Electrical category.

Cable Panel.

Pass-Through.

Product size offering – length. Listed on every product page with price listing. Note: Additional dimensions are provided for most products on the far right hand side of each page. These dimensions are not required in the ordering code.

Worksurfaces

Example: **Product:** Curvilinear Worksurface – Left

Specify: **1** **C W V L**



2 CWVL3042

3 CWVL3042–T431

4 CWVL3042–T890–CR

Base Code found on the product page to the left of the product name and a simple product illustration.

Compile product line.

Worksurface category.

Cur**V**ilinear shape.

Left hand configuration.

Worksurface size offering. Listed on every product page with price listing. Note: Additional dimensions are provided for most products on the far right hand side of each page. These dimensions are not required in the ordering code.

Laminate code for surface. See the Fabric & Finish listing in this section.

PVC code for trim. See the Fabric & Finish listing in this section.

Worksurfaces – Hardware

Example: **Product:** End Panel

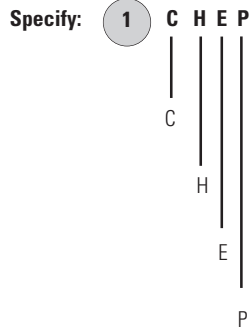

Base Code found on the product page to the left of the product name and a simple product illustration.

Compile product line.

Hardware category.

End Panel.

End **P**anel.

2 **CHEP-T431**

Laminte code for End Panel. See the Fabric & Finish listing in this section.

Storage

Example: **Product:** Box, Box, File Pedestal

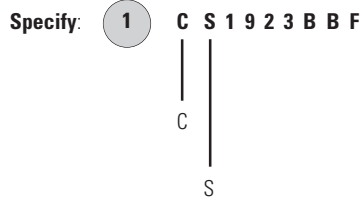

Base Code found on the product page to the left of the product name and a simple product illustration.

Compile product line.

Storage category.

2 **CS1923BBF**

19 Product Series.

3 **CS1923BBF**

23" Pedestal depth in inches.

4 **CS1923BBF**

Box drawer, **B**ox drawer, **F**ile drawer.



panels

THE INFORMATION LISTED BELOW PROVIDES YOU WITH BASIC FEATURES OF COMPILE PANELS:

- Compile Panels are:
 - Available in three (3) heights: 42", 54" and 66"; and seven (7) widths: 24", 30", 36", 42", 48" and 60".
 - 2 3/8" thick.
 - Monolithic
- Compile monolithic panels are not tackable.
- Raceway openings are 1.375" x 2.680".
- Panels 24" wide include raceway covers with 2 knockouts.
- Panels 30" – 60" wide include raceway covers with 3 knockouts.
- Opposite sides of each Module may have a different fabric within the same grade at no upcharge.
- If different grades of fabric are used on one panel, the entire panel must be priced at the highest grade.
- Standard with aluminum frame.
- Individual fabric covered modules incorporated into an aluminum frame.
- Reinforced aluminum raceway covers are included when ordering panel packages or may be ordered and shipped separately. Raceway covers can be replaced in the field to change a panel from non-powered to powered (or vice versa).
- Base raceway lifts up and locks in an upright 90-degree position, or can be removed for open access to base raceway.
- Electric knockouts in the raceway have color matched plastic covers that snap into place from the outside of the cover, when a duplex is not required. Electric knockout covers must be specified separately.
- 3 panel connector brackets per side for 42"h and 54"h come installed on panels and universal posts.
- 4 panel connector brackets per side for 66"h panels come installed on panels and universal posts.
- Panel connector brackets are opposite direction of each other per panel side, and can be removed with one screw per bracket.



MONOLITHIC PANEL PACKAGES - PAGES 16 & 17, 22-25

Non-Powered Compile Monolithic Fabric Panel Package

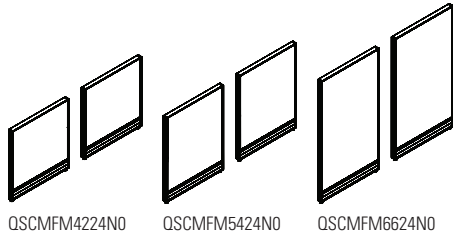

Powered Compile Monolithic Fabric Panel Package

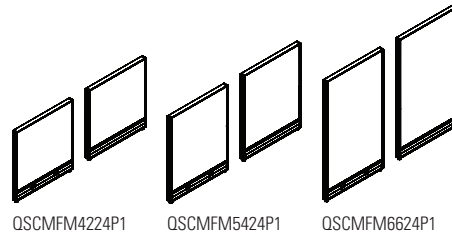

Non-Powered Compile Monolithic Fabric Panel Package

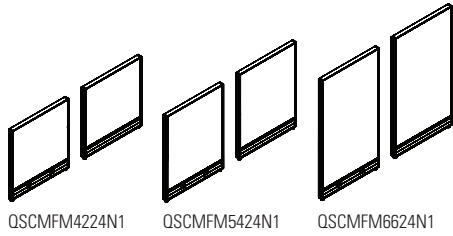

Powered Compile Monolithic Fabric Panel Package

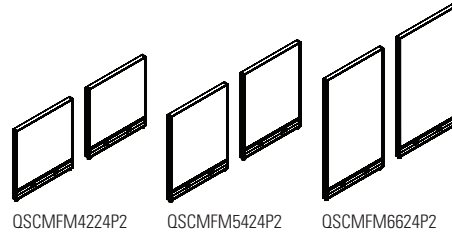

Non-Powered Compile Monolithic Fabric Panel Package

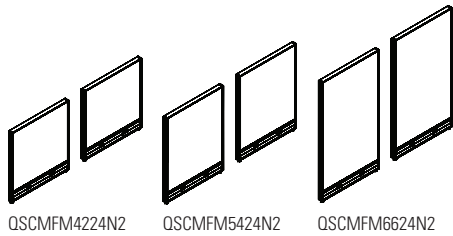

Model Definitions:

- N0 = No punch outs on raceways.
- N1 = Raceway punch out on one side.
- N2 = Raceway punch out on both sides.
- P1 = Power harness and raceway punch out on one side.
- P2 = Power harness and raceway punch outs on two sides.

RACEWAY COVER OPTIONS (Suffix)

- (N0) No Knockouts Side 1 and Side 2
- (N1) Knockouts Side 1 – No Knockout Side 2
- (N2) Knockouts Side 1 and Side 2
- (P1) Knockouts Side 1 – No Knockout Side 2
- (P2) Knockouts Side 1 and Side 2

PRIVACY GLASS / FELT / OVER PANELS

Fabric Over Panel

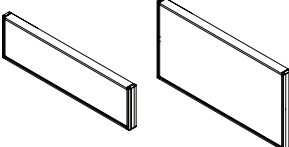

QSCMOF1224 QSCMOF2424

Compile Glazed Over Panels

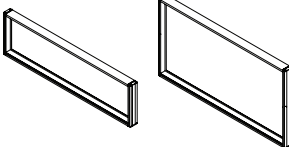

QSCMOG1224 QSCMOG2424

Privacy Glass Panel Width



QSCMPSEF1224

Embedded Felt Divider Over Panel

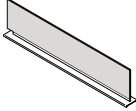

QSCMPSEF1224



This page provides an exploded view of a sample Panel Package highlighting each **Panel** component included within the package.

Package Components

Package 1 CMFM6636N0

- A. (1) 66" h x 36" w Monolithic Fabric Panel
- B. (2) 36" w Raceway Covers Without Knockouts

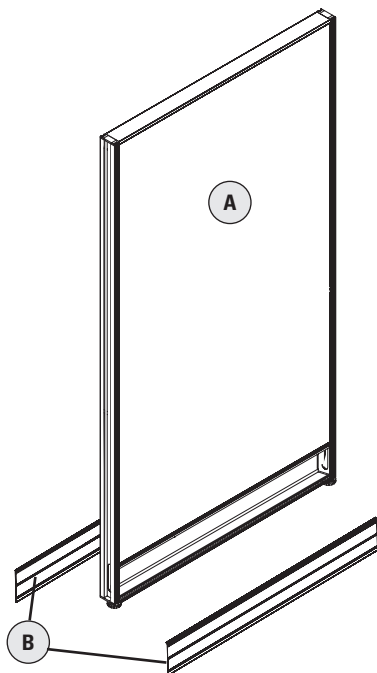

Package 2 CMFM6636P2

- C. (1) 66" h x 36" w Single Segmented Fabric Panel
- D. (2) 36" w Raceway Covers With Knockouts
- E. (1) 36" w Power Distribution Housing

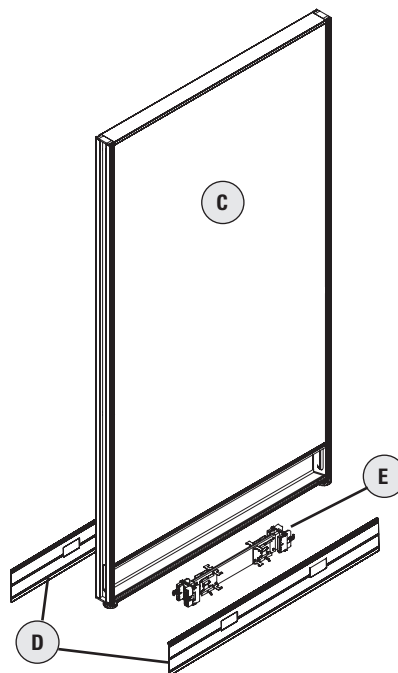

Package 3 CHP66-2

- F. (1) 66" h Universal Corner Post
- G. (2) Trim Inserts for 66" Universal Corner Post
- H. (1) Post Base Cover for 2-Way Application
- I. "Quick Connect" comes standard with Panels and Universal Corner Post

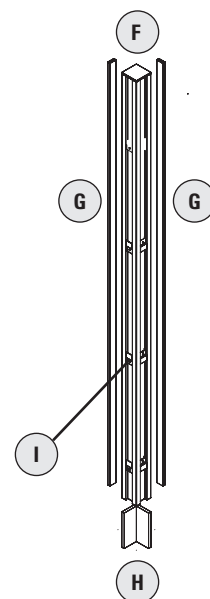

CMFMXXYYN - NON-POWERED COMPILE FABRIC MONOLITHIC PANEL PACKAGE

- Non powered.
- Includes one panel and two raceway covers with no punchouts.
- Individual fabric-covered modules incorporated into an aluminum frame.
- Opposite sides of each module may have a different fabric within the same grade at no upcharge.
- If different grades of fabric are used on one panel, the entire panel must be priced at highest grade.
- Panels are not tackable or acoustical.
- Note: Trim is not required at a straight connection between two panels of the same height.
- 3 Panel connector brackets per side come standard with 42”h, 48”h and 54”h panels.
- 4 Panel connector brackets per side come standard with 66”h panels.
- Panels contain leveling glides. Maximum extension of glides is 2”.

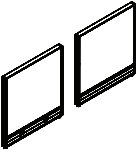
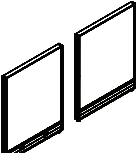
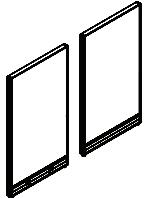
	DESCRIPTION	PRODUCT CODE	LIST PRICE	DIMENSIONS/INCHES		
				H	W	D
	Non-Powered Compile Fabric Monolithic Panel Package - 42"	QSCMFM4224N_	365	42	24	2.38
		QSCMFM4230N_	412	42	30	2.38
		QSCMFM4236N_	447	42	36	2.38
		QSCMFM4242N_	494	42	42	2.38
		QSCMFM4248N_	525	42	48	2.38
		QSCMFM4260N_	613	42	60	2.38
	Non-Powered Compile Fabric Monolithic Panel Package - 54"	QSCMFM5424N_	381	54	24	2.38
		QSCMFM5430N_	431	54	30	2.38
		QSCMFM5436N_	480	54	36	2.38
		QSCMFM5442N_	533	54	42	2.38
		QSCMFM5448N_	561	54	48	2.38
		QSCMFM5460N_	663	54	60	2.38
	Non-Powered Compile Fabric Monolithic Panel Package - 66"	QSCMFM6624N_	426	66	24	2.38
		QSCMFM6630N_	489	66	30	2.38
		QSCMFM6636N_	558	66	36	2.38
		QSCMFM6642N_	627	66	42	2.38
		QSCMFM6648N_	678	66	48	2.38
		QSCMFM6660N_	829	66	60	2.38

Raceway Cover Options (1) Shown

- **RACEWAY COVER OPTIONS (Suffix)**
 - (0) No Knockouts Side 1 and Side 2
 - (1) Knockouts Side 1 – No Knockout Side 2
 - (2) Knockouts Side 1 and Side 2



CMFMXXYP - POWERED COMPILE FABRIC MONOLITHIC PANEL PACKAGE

- With power distribution harness.
- Includes one panel, power harness, one raceway cover with punchout and one raceway cover with no punchout.
- Individual fabric-covered modules incorporated into an aluminum frame.
- Opposite sides of each module may have a different fabric within the same grade at no upcharge.
- If different grades of fabric are used on one panel, the entire panel must be priced at highest grade.
- Panels are not tackable or acoustical.
- Note: Trim is not required at a straight connection between two panels of the same height.
- 3 Panel connector brackets per side come standard with 42”h, 48”h and 54”h panels.
- 4 Panel connector brackets per side come standard with 66”h panels.
- Panels contain leveling glides. Maximum extension of glides is 2”.

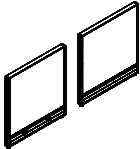
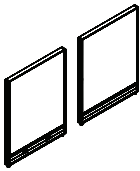
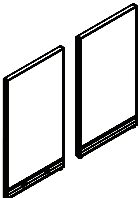
	DESCRIPTION	PRODUCT CODE	LIST PRICE	DIMENSIONS/INCHES		
				H	W	D
	Powered Compile Fabric Monolithic Panel Package - 42"	QSCMFM4224P_	519	42	24	2 3/8
		QSCMFM4230P_	619	42	30	2 3/8
		QSCMFM4236P_	665	42	36	2 3/8
		QSCMFM4242P_	715	42	42	2 3/8
		QSCMFM4248P_	764	42	48	2 3/8
		QSCMFM4260P_	854	42	60	2 3/8
	Powered Compile Fabric Monolithic Panel Package - 54"	QSCMFM5424P_	533	54	24	2 3/8
		QSCMFM5430P_	635	54	30	2 3/8
		QSCMFM5436P_	696	54	36	2 3/8
		QSCMFM5442P_	754	54	42	2 3/8
		QSCMFM5448P_	801	54	48	2 3/8
		QSCMFM5460P_	902	54	60	2 3/8
	Powered Compile Fabric Monolithic Panel Package - 66"	QSCMFM6624P_	578	66	24	2 3/8
		QSCMFM6630P_	696	66	30	2 3/8
		QSCMFM6636P_	775	66	36	2 3/8
		QSCMFM6642P_	847	66	42	2 3/8
		QSCMFM6648P_	918	66	48	2 3/8
		QSCMFM6660P_	1069	66	60	2 3/8

Raceway Cover Options (1) Shown

- **RACEWAY COVER OPTIONS (Suffix)**
 - (1) Knockouts Side 1 – No Knockout Side 2
 - (2) Knockouts Side 1 and Side 2

CMOF - COMPILE FABRIC OVER PANEL

- Fabric-covered modules incorporated into an aluminum frame.
- Opposite sides of each module may have a different fabric within the same grade at no upcharge.
- If different grades of fabric are used on one panel, the entire panel must be priced at highest grade.
- One CSHD Slider Kit for Over Panel included
- Note: Trim is not required at a straight connection between two panels of the same height.
- Maximum stacking one high. Not load bearing.

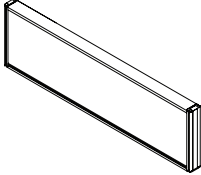
DESCRIPTION	PRODUCT CODE	LIST PRICE	DIMENSIONS/INCHES		
			H	W	D
 <p>Compile Fabric Over Panel</p>	QSCMOF1224	205	12	24	2.3
	QSCMOF1230	240	12	30	2.3
	QSCMOF1236	267	12	36	2.3
	QSCMOF1242	302	12	42	2.3
	QSCMOF1248	349	12	48	2.3
	QSCMOF1260	429	12	60	2.3
	QSCMOF2424	308	24	24	2.3
	QSCMOF2430	356	24	30	2.3
	QSCMOF2436	398	24	36	2.3
	QSCMOF2442	446	24	42	2.3
	QSCMOF2448	481	24	48	2.3
	QSCMOF2460	614	24	60	2.3

CMOG - COMPILE GLAZED OVER PANEL

- Glazed module incorporated into an aluminum frame.
- One CSHD Slider Kit for Over Panel included
- Available in clear (CLR) glass.
- Note: Trim is not required at a straight connection between two panels of the same height.
- Maximum stacking one high. Not load bearing.

DESCRIPTION	PRODUCT CODE	LIST PRICE	DIMENSIONS/INCHES		
			H	W	D
 <p>Compile Glazed Over Panel</p>	QSCMOG1224	183	12	24	2.3
	QSCMOG1230	213	12	30	2.3
	QSCMOG1236	238	12	36	2.3
	QSCMOG1242	266	12	42	2.3
	QSCMOG1248	305	12	48	2.3
	QSCMOG1260	380	12	60	2.3
	QSCMOG2424	272	24	24	2.3
	QSCMOG2430	294	24	30	2.3
	QSCMOG2436	346	24	36	2.3
	QSCMOG2442	388	24	42	2.3
	QSCMOG2448	414	24	48	2.3
	QSCMOG2460	531	24	60	2.3



CMPSEGXX - COMPILE PRIVACY GLASS PANEL WIDTH

- Attaches on top of Compile Panels to add privacy or divide space.
- Available in clear (CLR) glass.
- Width dimensions given are width of glass only.
- Attachment hardware is provided for attaching to panels.

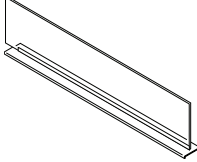
DESCRIPTION	PRODUCT CODE	LIST PRICE	DIMENSIONS/INCHES		
			H	W	D
 <p>Compile Privacy Glass</p>	QSCMPSEG1224	264	12	24	2.41
	QSCMPSEG1230	288	12	30	2.41
	QSCMPSEG1236	306	12	36	2.41
	QSCMPSEG1242	319	12	42	2.41
	QSCMPSEG1248	339	12	48	2.41
	QSCMPSEG1260	360	12	60	2.41

CMPSEF - EMBEDDED FELT DIVIDER OVER PANEL

- Privacy felt panel integrated with aluminum top trim.
- Attaches on top of panels to add privacy or divide space.
- Includes aluminum trim with channel and felt tile.
- Felt and attachment hardware to ship separately
- 9mm Felt material is tackable and comes in 3 different colors. Please specify color.

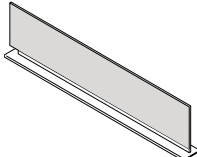
DESCRIPTION	PRODUCT CODE	LIST PRICE	DIMENSIONS/INCHES		
			H	W	D
 <p>12" Integrated Felt Divider, Panel Width</p>	QSCMPSEF1224	107	12	24	2.41
	QSCMPSEF1230	124	12	30	2.41
	QSCMPSEF1236	148	12	36	2.41
	QSCMPSEF1242	163	12	42	2.41
	QSCMPSEF1248	244	12	48	2.41
	QSCMPSEF1260	285	12	60	2.41

CMLEPXXXNC - END OF RUN GALLERY PANEL WITH NO END CONNECTION

- Provides floor standing support while enclosing the end of a panel run.
- Attached at the end of a straight panel run with connectors to form a T configuration.
- No connections at both ends, connection is at the center interior face.
- Includes all attachment hardware and glides.
- Total height is inclusive of panel glides extended to their full height.
- 51" wide gallery panel accommodates two 24" deep surface while the 63" wide accommodates two 30" deep surfaces.
- Please specify LP laminate finish and PVC edge finish.
- If a wood grain laminate is chosen, grain direction run horizontally.
- Gallery panel is edged in PVC on exposed edges and self edged on bottom.

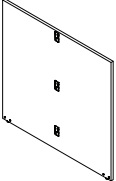
DESCRIPTION	PRODUCT CODE	LIST PRICE	DIMENSIONS/INCHES		
			H	W	D
 End of Run Gallery Panel	QSCMLEP4251NC	789	42	50.30	1
	QSCMLEP4263NC	917	42	62.30	1
	QSCMLEP4851NC	867	48	50.30	1
	QSCMLEP4863NC	1007	48	62.30	1
	QSCMLEP5451NC	945	54	50.30	1
	QSCMLEP5463NC	1099	54	62.30	1

CMLMPXXXNC - MIDDLE OF RUN GALLERY PANEL WITH NO END CONNECTION

- Provides floor standing support in the middle of a panel run.
- Attached in the middle of a straight panel run with connectors to form an X configuration.
- No connections at both ends, connection is at center on both faces.
- Includes all attachment hardware and glides.
- Total height is inclusive of panel glides extended to their full height.
- 51" wide gallery panel accommodates two 24" deep surface while the 63" wide accommodates two 30" deep surfaces.
- Please specify LP laminate finish and PVC edge finish.
- If a wood grain laminate is chosen, grain direction run horizontally.
- Gallery panel is edged in PVC on exposed edges and self edged on bottom.

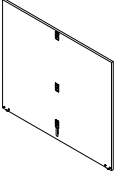
DESCRIPTION	PRODUCT CODE	LIST PRICE	DIMENSIONS/INCHES		
			H	W	D
 Middle of Run Gallery Panel	QSCMLMP4251NC	918	42	50.30	1
	QSCMLMP4263NC	1044	42	62.30	1
	QSCMLMP4851NC	996	48	50.30	1
	QSCMLMP4863NC	1136	48	62.30	1
	QSCMLMP5451NC	1074	54	50.30	1
	QSCMLMP5463NC	1228	54	62.30	1

CMLSEPLXXXNC - SINGLE END OF RUN GALLERY PANEL WITH NO END CONNECTION

- Provides floor standing support while enclosing the end of a panel run.
- Attached at the end of a straight panel run with connectors to form an L configuration.
- No connections at both ends, connection is at center on both faces.
- Includes all attachment hardware and glides.
- Total height is inclusive of panel glides extended to their full height.
- 27" wide gallery panel accommodate two 24" deep surface while the 33" wide accommodates two 30" deep surfaces.
- Please specify LP laminate finish and PVC edge finish.
- If a wood grain laminate is chosen, grain direction run horizontally.
- Gallery panel is edged in PVC on exposed edges and self edged on bottom.

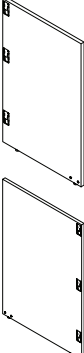
DESCRIPTION	PRODUCT CODE	LIST PRICE	DIMENSIONS/INCHES		
			H	W	D
 Single End of Run Gallery Panel	QSCMLSEPL4227NC	601	42	26.30	1
	QSCMLSEPR4227NC	601	42	26.30	1
	QSCMLSEPL4827NC	657	48	26.30	1
	QSCMLSEPR4827NC	657	48	26.30	1
	QSCMLSEPL5427NC	713	54	26.30	1
	QSCMLSEPR5427NC	713	54	26.30	1
	QSCMLSEPL4233NC	620	42	32.33	1
	QSCMLSEPR4233NC	620	42	32.33	1
	QSCMLSEPL4833NC	677	48	32.33	1
	QSCMLSEPR4833NC	677	48	32.33	1
	QSCMLSEPL5433NC	734	54	32.33	1
	QSCMLSEPR5433NC	734	54	32.33	1



CMLSMPXXXXNC - SINGLE MIDDLE OF RUN GALLERY PANEL WITH NO END CONNECTION

- Provides floor standing support at the middle of a panel run.
- Attached in the middle of a straight panel run with connectors to form a T configuration.
- No connections at the exposed end, connection is at both the interior and exterior face near the opposite end.
- Includes all attachment hardware and glides.
- Total height is inclusive of panel glides extended to their full height.
- 27" wide gallery panel accommodates a 24" deep surface while the 33" wide accommodates a 30" deep surface.
- Please specify LP laminate finish and PVC edge finish.
- If a wood grain laminate is chosen, grain direction run horizontally.
- Gallery panel is edged in PVC on exposed edges and self edged on bottom.

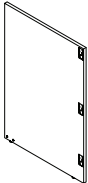
	DESCRIPTION	PRODUCT CODE	LIST PRICE	DIMENSIONS/INCHES		
				H	W	D
	Single Middle of Run Gallery Panel	QSCMLSMP4227NC	730	42	26.30	1
		QSCMLSMP4827NC	786	48	26.30	1
		QSCMLSMP5427NC	842	54	26.30	1
		QSCMLSMP4233NC	752	42	32.30	1
		QSCMLSMP4833NC	808	48	32.30	1
		QSCMLSMP5433NC	866	54	32.30	1

CMLPXXXX - END OF RUN GALLERY PANEL WITH END CONNECTIONS

- Provides floor standing support while enclosing the end of a panel run.
- Attached at the end of a straight panel run with connectors to form a T configuration.
- Connections at both ends as well as the center on the interior face.
- Includes all attachment hardware and glides.
- Total height is inclusive of panel glides extended to their full height.
- 51" wide gallery panel accommodates two 24" deep surface while the 63" wide accommodates two 30" deep surfaces.
- Please specify LP laminate finish and PVC edge finish.
- If a wood grain laminate is chosen, grain direction run horizontally.
- Gallery panel is edged in PVC on exposed edges and self edged on edge connecting to panel and bottom edge.

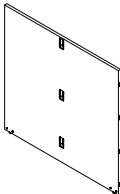
	DESCRIPTION	PRODUCT CODE	LIST PRICE	DIMENSIONS/INCHES		
				H	W	D
	End of Run Gallery Panel	QSCMLEP4251	821	42	50.30	1
		QSCMLEP4263	946	42	62.30	1
		QSCMLEP4851	898	48	50.30	1
		QSCMLEP4863	1038	48	62.30	1
		QSCMLEP5451	976	54	50.30	1
		QSCMLEP5463	1130	54	62.30	1

CMLMPXXXX - MIDDLE OF RUN GALLERY PANEL WITH END CONNECTIONS

- Provides floor standing support in the middle of a panel run.
- Attached in the middle of a straight panel run with connectors to form an X configuration.
- Connections at both ends as well as the center on the interior face.
- Includes all attachment hardware and glides.
- Total height is inclusive of panel glides extended to their full height.
- 51" wide gallery panel accommodates two 24" deep surface while the 63" wide accommodates two 30" deep surfaces.
- Please specify LP laminate finish and PVC edge finish.
- If a wood grain laminate is chosen, grain direction run horizontally.
- Gallery panel is edged in PVC on exposed edges and self edged on edge connecting to panel and bottom edge.

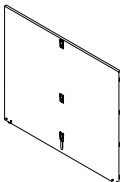
	DESCRIPTION	PRODUCT CODE	LIST PRICE	DIMENSIONS/INCHES		
				H	W	D
	Middle of Run Gallery Panel	QSCMLMP4251	923	42	50.30	1
		QSCMLMP4263	1049	42	62.30	1
		QSCMLMP4851	1001	48	50.30	1
		QSCMLMP4863	1141	48	62.30	1
		QSCMLMP5451	1078	54	50.30	1
		QSCMLMP5463	1235	54	62.30	1

CMLSEPLXXXX - SINGLE END PANEL WITH END CONNECTIONS

- Provides floor standing support while enclosing the end of a panel run.
- Attached at the end of a straight panel run with connectors to form an L configuration.
- Connections are at the exposed end on one side and near the end on the other interior face.
- Total height is inclusive of panel glides extended to their full height.

- 27" wide gallery panel accommodates a 24" deep surface while the 33" wide accommodates a 30" deep surface.
- Please specify LP laminate finish and PVC edge finish.
- If a wood grain laminate is chosen, grain direction run horizontally.
- Gallery panel is edged in PVC on exposed edges and self edged on edge connecting to panel and bottom edge.

	DESCRIPTION	PRODUCT CODE	LIST PRICE	DIMENSIONS/INCHES			
				H	W	D	
	Single End of Run Gallery Panel	QSCMLSEPL4227	615	42	26.30	1	
		QSCMLSEPR4227	615	42	26.30	1	
		QSCMLSEPL4827	673	48	26.30	1	
		QSCMLSEPR4827	673	48	26.30	1	
		QSCMLSEPL5427	728	54	26.30	1	
		QSCMLSEPR5427	728	54	26.30	1	
			QSCMLSEPL4233	635	42	32.33	1
			QSCMLSEPR4233	635	42	32.33	1
			QSCMLSEPL4833	691	48	32.33	1
			QSCMLSEPR4833	691	48	32.33	1
QSCMLSEPL5433			750	54	32.33	1	
QSCMLSEPR5433			750	54	32.33	1	

CMLSMPXXXX - SINGLE MIDDLE OF RUN GALLERY PANEL WITH END CONNECTIONS

- Provides floor standing support at the middle of a panel run.
- Attached in the middle of a straight panel run with connectors to form a T configuration
- Connections are at the exposed end and at the interior and exterior near the opposite end.
- Includes all attachment hardware and glides.
- Total height is inclusive of panel glides extended to their full height.

- 27" wide gallery panel accommodates a 24" deep surface while the 33" wide accommodates a 30" deep surface.
- Please specify LP laminate finish and PVC edge finish.
- If a wood grain laminate is chosen, grain direction run horizontally.
- Gallery panel is edged in PVC on exposed edges and self edged on edge connecting to panel and bottom edge.

	DESCRIPTION	PRODUCT CODE	LIST PRICE	DIMENSIONS/INCHES		
				H	W	D
	Single Middle of Run Gallery Panel	QSCMLSMP4227	744	42	26.30	1
		QSCMLSMP4827	801	48	26.30	1
		QSCMLSMP5427	855	54	26.30	1
		QSCMLSMP4233	767	42	32.30	1
		QSCMLSMP4833	824	48	32.30	1
		QSCMLSMP5433	882	54	32.30	1



CMLXPLXXXNC - EXTENSION END OF RUN, LEFT, NO CONNECTION

- Provides floor standing support while enclosing the end of a gallery panel run.
- Attached at the end of a gallery panel to extend the gallery panel run.
- Connections only at one exposed end.
- Includes all attachment hardware and glides.
- Total height is inclusive of panel glides extended to their full height.
- Please specify LP laminate finish and PVC edge finish.
- If a wood grain laminate is chosen, grain direction run horizontally.
- Gallery panel is edged in PVC on exposed edges and self edged on edge connecting to panel.

DESCRIPTION	PRODUCT CODE	LIST PRICE	DIMENSIONS/INCHES		
			H	W	D
 Extension End of Run Gallery Panel	QSCMLXPL4224NC	403	42	24	1
	QSCMLXPL4230NC	472	42	30	1
	QSCMLXPL4236NC	543	42	36	1
	QSCMLXPL4242NC	684	42	42	1
	QSCMLXPL4248NC	703	42	48	1
	QSCMLXPL4824NC	415	48	24	1
	QSCMLXPL4830NC	488	48	30	1
	QSCMLXPL4836NC	558	48	36	1
	QSCMLXPL4842NC	703	48	42	1
	QSCMLXPL4848NC	725	48	48	1
	QSCMLXPL5424NC	444	54	24	1
	QSCMLXPL5430NC	521	54	30	1
	QSCMLXPL5436NC	598	54	36	1
	QSCMLXPL5442NC	676	54	42	1
	QSCMLXPL5448NC	830	54	48	1

CMLXPLXXXNC • EXTENSION END OF RUN, RIGHT, NO CONNECTION

- Provides floor standing support while enclosing the end of a gallery panel run.
- Attached at the end of a gallery panel to extend the gallery panel run.
- Connections only at one exposed end.
- Includes all attachment hardware and glides.
- Total height is inclusive of panel glides extended to their full height.
- Please specify LP laminate finish and PVC edge finish.
- If a wood grain laminate is chosen, grain direction run horizontally.
- Gallery panel is edged in PVC on exposed edges and self edged on edge connecting to panel.

DESCRIPTION	PRODUCT CODE	LIST PRICE	DIMENSIONS/INCHES		
			H	W	D
 Extension End of Run Gallery Panel	QSCMLXPR4224NC	403	42	24	1
	QSCMLXPR4230NC	472	42	30	1
	QSCMLXPR4236NC	543	42	36	1
	QSCMLXPR4242NC	684	42	42	1
	QSCMLXPR4248NC	703	42	48	1
	QSCMLXPR4824NC	415	48	24	1
	QSCMLXPR4830NC	488	48	30	1
	QSCMLXPR4836NC	558	48	36	1
	QSCMLXPR4842NC	703	48	42	1
	QSCMLXPR4848NC	725	48	48	1
	QSCMLXPR5424NC	444	54	24	1
	QSCMLXPR5430NC	521	54	30	1
	QSCMLXPR5436NC	598	54	36	1
	QSCMLXPR5442NC	676	54	42	1
	QSCMLXPR5448NC	830	54	48	1

CMHLPBB01 - LAMINATE PANEL BRACKET

- Laminate panel bottom bracket connects two gallery end panels at bottom with screws.
- Available in standard paint colors.
- Screws are included with the bracket.

	DESCRIPTION	PRODUCT CODE	LIST PRICE	DIMENSIONS/INCHES		
				H	W	D
	Bracket	QSCMHL PBB01	46	1.5	8	1

CMHLPCB01 - LAMINATE PANEL CORNER BRACKET



- Gallery panel corner bottom bracket connects two laminate panels at 90 degrees.
- Available in standard paint colors.
- Screws are included with the bracket.

	DESCRIPTION	PRODUCT CODE	LIST PRICE	DIMENSIONS/INCHES		
				H	W	D
	Corner Bracket	QSCMHL PCB01	44	1.5	4	4



CHP POST PACKAGE

- Universal Post with all "Quick-Connection" clips.
- Post trim(s)
- Post base and top cap

	DESCRIPTION	PRODUCT CODE	LIST PRICE	DIMENSIONS/INCHES		
				H	W	D
	2 - Way Post	QSCHP42-2	115	42	2.3	2.3
		QSCHP54-2	142	54	2.3	2.3
		QSCHP66-2	167	66	2.3	2.3
	3 - Way Post	QSCHP42-3	101	42	2.3	2.3
		QSCHP54-3	126	54	2.3	2.3
		QSCHP66-3	151	66	2.3	2.3
	4 - Way Post *No trim or base. Includes top cap only.	QSCHP42-4	82	42	2.3	2.3
		QSCHP54-4	106	54	2.3	2.3
		QSCHP66-4	126	66	2.3	2.3

CHPXW - 90 DEGREE CORNER POST KIT FOR OVER PANELS

- Specify the corner post height that matches the height of the over panel
- 2-way kits include 2 trims (CMETPxx), 2 way post base (CMPCxx) and post cap (CMPC).
- 3-way kits include 2 trim (CMETPxx), 3 way post base (CMPCxx) and post cap (CMPC).
- 4-way kits include post cap (CMPC) only.

	DESCRIPTION	PRODUCT CODE	LIST PRICE	DIMENSIONS/INCHES		
				H	W	D
	90 Degree Corner Post Kit for Over Panels	QSCHOP12-2	75	12	2.3	2.3
		QSCHOP12-3	64	12	2.3	2.3
		QSCHOP12-4	44	12	2.3	2.3
		QSCHOP24-2	84	24	2.3	2.3
		QSCHOP24-3	75	24	2.3	2.3
		QSCHOP24-4	63	24	2.3	2.3

CMET - END OF RUN TRIM INSERT FOR PANEL

- Trim inserts are not included with panels.
- Cannot be used for a universal post application.
- Used at the end of each panel run and cannot be used to attach a panel run to a fixed wall.
- Vertical trims must be specified separately. Trim snaps in the panel at the end of run.
- Standard Compile paint options.
- See Panel Configuration Tips for application.
- Trims are PVC.

DESCRIPTION	PRODUCT CODE	LIST PRICE	DIMENSIONS/INCHES		
			H	W	D



End of Run Trim Insert for Panel	QSCMET42	21	42	2.3	0.5
	QSCMET54	25	54	2.3	0.5
	QSCMET66	27	66	2.3	0.5

CMET - TRIM INSERT FOR STEP DOWN

- Does not come with a post. Trim inserts are not included with Universal Corner Posts.
- Specify to meet the taller post.
- Trim snaps in the post or end of run at a change in height.
- Available in standard Compile paint options.
- Can not be applied to 60 degree posts.
- See Panel Configuration Tips for application.

DESCRIPTION	PRODUCT CODE	LIST PRICE	DIMENSIONS/INCHES		
			H	W	D



Trim Insert for Step Down	QSCMET12	14	12	2.3	
	QSCMET24	24	24	2.3	



CMRCXXNP - COMPILE RACEWAY COVER - WITHOUT KNOCKOUTS

- No electrical knockouts included.
- Note: Made of reinforced aluminum.

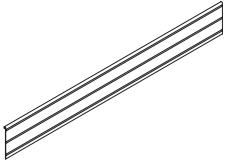
	DESCRIPTION	PRODUCT CODE	LIST PRICE	DIMENSIONS/INCHES		
				H	W	D
	Compile Raceway Cover Without Knockouts	QSCMRC24NP	18	5	24	
		QSCMRC30NP	22	5	30	
		QSCMRC36NP	25	5	36	
		QSCMRC42NP	27	5	42	
		QSCMRC48NP	30	5	48	
		QSCMRC54NP	37	5	54	
		QSCMRC60NP	39	5	60	
		QSCMRC60NP	39	5	60	

CMRCXXPO - COMPILE RACEWAY COVER - WITH KNOCKOUTS

- Contains one knockout for 24" w and three knockouts for 30" w+.
- Raceway Knockout Cover must be added to openings where duplex receptacles are not used.
- Note: Made of reinforced aluminum.

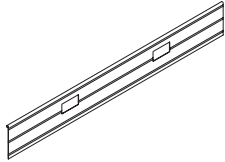
	DESCRIPTION	PRODUCT CODE	LIST PRICE	DIMENSIONS/INCHES		
				H	W	D
	Compile Raceway Cover With Knockouts	QSCMRC24PO	18	5	24	
		QSCMRC30PO	22	5	30	
		QSCMRC36PO	25	5	36	
		QSCMRC42PO	27	5	42	
		QSCMRC48PO	30	5	48	
		QSCMRC54PO	37	5	54	
		QSCMRC60PO	39	5	60	
		QSCMRC60PO	39	5	60	

CMRCB01 - COMPILE RACEWAY KNOCKOUT COVER

- Fills knockout when duplex is not used.
- Available in Black, White, Nevada and Fog.
- Note: Knockout covers are made of plastic.

	DESCRIPTION	PRODUCT CODE	LIST PRICE	DIMENSIONS/INCHES		
				H	W	D
	Compile Raceway Knockout Cover	QSCMRCB01	17	1.5	2.756	

CHWAXX - WALL ADAPTER

- Same profile as vertical extrusion.
- Wall attachment hardware not provided.
- Made of aluminum.

	DESCRIPTION	PRODUCT CODE	LIST PRICE	DIMENSIONS/INCHES		
				H	W	D
	Wall Adapter	QSCHWA42	64	42	2.36	.79
		QSCHWA54	81	54	2.36	.79
		QSCHWA66	94	66	2.36	.79

CWMA - VERTICAL CHANNEL

- Used to attach system components to fixed wall.
- Panel frame finish.
- Comes in 60" length only.
- Care should be taken to mount adapters only to wall studs using correct fasteners.
- Does not include mounting hardware. Mounting hardware selection to be based on wall material. Sold in pairs.
- Failure to do this may result in collapse of the unit and subsequent possible personal injury.
- Complete vertical channels cannot be shared.

	DESCRIPTION	PRODUCT CODE	LIST PRICE	DIMENSIONS/INCHES		
				H	W	D
	Vertical Channel	QSCWMA60	39	60	0.6	0.7



CMPC - UNIVERSAL POST CAP

- Comes standard with universal post.
- Specified separately for reconfiguration purposes.
- Available in standard Compile paint options.
- Made of PVC.

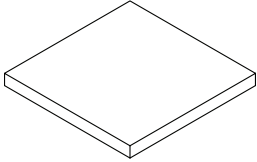
	DESCRIPTION	PRODUCT CODE	LIST PRICE	DIMENSIONS/INCHES		
				H	W	D
	Universal Post Cap	QSCMPC	8	.7	2.5	2.5

CMPC - POST BASE COVER

- Post Base Covers are not included with Universal Corner Posts.
- Base trim for universal post. These are connected with screws at the base and the trims at the post will slide to meet.
- Available for 2-way and 3-way configurations.
- Finish is smooth plastic.
- Available in standard Compile paint options.

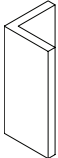
	DESCRIPTION	PRODUCT CODE	LIST PRICE	DIMENSIONS/INCHES		
				H	W	D
	Post Base Cover - 3-Way Connection	QSCMPC1	13	5	2.3	.033
	Post Base Cover - 2-Way Connection	QSCMPC2	14	5	2.3	2.31

CMPS - POST SEPARATOR

- Creates a diagonal division within a compile post.
- Please specify post height.

	DESCRIPTION	PRODUCT CODE	LIST PRICE	DIMENSIONS/INCHES		
				H	W	D
	Post Separator	QSCMPS01	154	96	3.25	14 gauge-

electrical

STEP-BY-STEP SPECIFICATION – 8-WIRE ELECTRICAL SYSTEM

Step 1 Determine the location of the source power entering the Panel Run.

1. At the base of the Panel.
 - (a) Use CE8FR1 Reversible Floor Power Entry (default to CE8FR1).
 - (b) Select the Panel to which the Floor Power Entry will be attached.
 - (c) Select the side of the Panel and the receptacle outlet to which the Floor Power Entry is to be attached.

Note: When using Pass Through Connectors in conditions other than a straight line, you must use a CE8CI-1 I-Connector along with a CE8CP17 Flexible Mesh Jumper Cable through the corner post.

Step 2 Determine which Panels are to be powered.

1. Use CE8PD Power Distribution Housing that corresponds with the width of the Panel.

Step 3 Connect power to the powered Panels.

1. Use CE8CP17 Flexible Mesh Jumper Cable between two adjacent powered Panels.
2. Use CE8CP17 Flexible Mesh Jumper Cable between two adjacent powered Panels separated by a post.
3. Use CE8CP17 Flexible Mesh cable (to turn the post) and a CE8CI-1 "I" Connector to attach the CE8CP Pass Through Cable.
 - (a) The length of the Pass-Through Cable is calculated by adding together the widths of the non-powered Panels that separate the two powered Panels and applying an additional 16" to the total. (CE8PD Power Distribution Housing is positioned 8" in from the ends of the powered Panel.)
 - (b) An additional 3" must be added to the Pass-Through Cable for each post that the cable passes through.
 - (c) Subtract 17" from the total length to find the pass through cable length required.
4. From the price list, select the CE8CP Pass-Through Cable that matches the calculated length. If the length is between listed sizes, use the next size up.

Step 4 Determine the location and circuitry of the receptacles.

1. Each powered Panel has four (4) potential locations for CE8RD Duplex Receptacles – 2 per side. (Exception: 24" wide Panel has only two potential locations – 1 per side.)
2. At each receptacle location there is a choice of four circuit options. Select a circuit option for each location. Circuits one & two are utility circuits; circuits A & B are dedicated circuits.

COMPILE'S 8-WIRE ELECTRICAL SYSTEM

Electrical

This modification allows for the integration of the commonly required "2+2" configuration (2 utility circuits, 2 dedicated circuits) found in the source power of most of today's North American buildings.

This system is rated for connection to:

1. A grounded 120/240V, single phase, 20 A, 60Hz
2. A 120/208V, 3 phase, 20 A, 60Hz branch circuit

EQUIPMENT AMPERAGE

Calculator	0.25
Electric Eraser	0.50
Pencil Sharpener.....	1.00
Radio	0.05
Paper Shredder.....	4.40 - 13.00
Electric Typewriter	1.20
Personal Computer	2.00 - 4.00
Video Display Terminal	0.08
Draft / Letter Quality Printer	1.20 - 3.00
Laser Printer.....	5.00 - 8.00
Processor / Disk Unit.....	1.00 - 10.00

Data/Comm

Compile's duplex receptacle openings (1.345 x 2.80) will conform to the ANSI/TIA/EIA Furniture Opening Standard of 1.38 +/- .035 x 2.71 +/- .04

Desk Top Plotter	1.50
Fan	1.00
Heater	8.50 - 12.50
Coffee Pot.....	15.00
Task Light	1.00
Slide Projector	2.00 - 6.00

Since some equipment, such as large copiers, printers, plotters, heaters and coffee makers would occupy most of the circuit capacity, it is recommended that such devices be supplied with the power directly from the wall or building receptacle.



Wiring Schematic

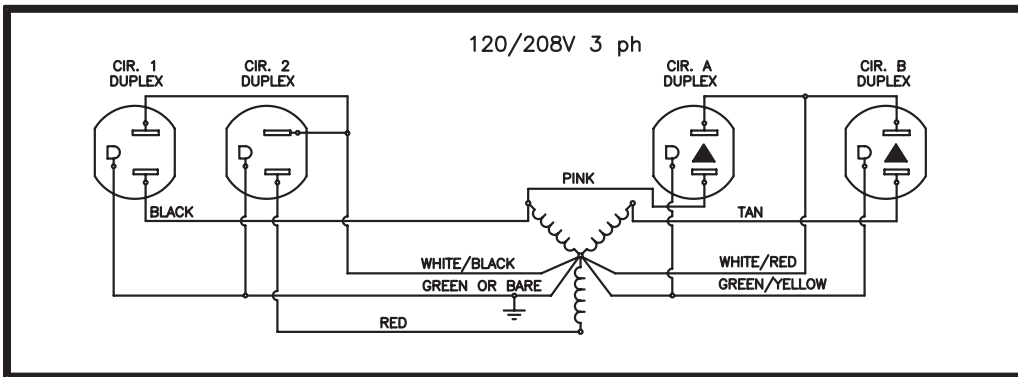
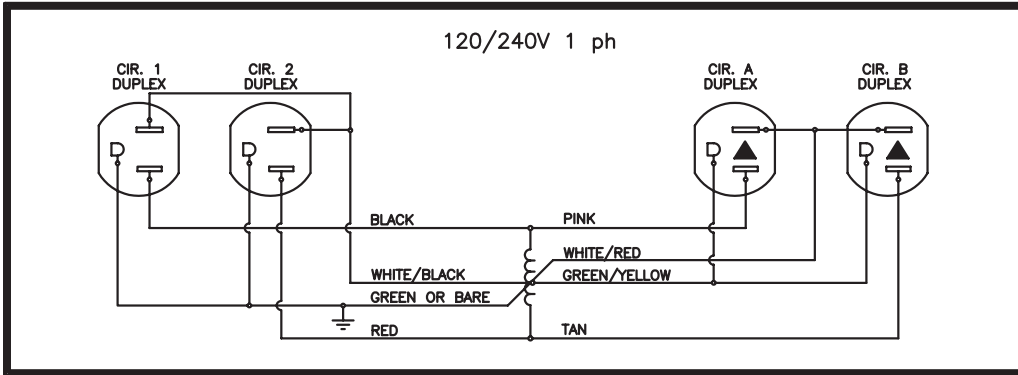

Defining "2 + 2" Wiring Configurations

2 + 2 Configuration (8 wire, 4 circuit)

Two Utility Circuits [Compile's new #1 & #2 circuits] share one neutral wire and one ground wire.
 (2 hot [circuit] wires + 1 neutral wire*** + 1 green ground wire* = 4 wires)

Two Dedicated Circuits [Compile's new "A" & "B" circuits] share one neutral wire and one ground wire.
 (2 hot [circuit] wires + 1 neutral wire*** + 1 green/yellow ground wire** = 4 wires)

Note:

It is the ground wire that makes the difference between "Utility" and "Dedicated" circuits. Refer to Wiring Schematics found above.

* A Green ground wire is a "system" ground. This means it could be grounded to any piece of metal, including the Panel.

** A Green/Yellow ground wire is isolated, within the wiring conduit, all the way back to the box at the source (building ground).

*** All Neutral Wires are 10 gauge rather than 12 gauge meaning they are larger than normal, allowing greater protection against "noise" or interference on the circuit.

This page provides an exploded view of a sample configuration highlighting each **Electrical** component required when specifying this configuration.

Components

- A. CE8PD36 Power Distribution Housing
Note: 8 wire, 4 circuits, 2+2 configuration
- B. CE8CP17 Flexible Mesh Jumper Cable (connects two panels side by side or separated by a post)
- C. CE8RD Duplex Receptacle
- D. CE8CI-1 "I" Connector
- E. CE8CP Pass-Through Cable
Note: Must run in a straight line application only
Note: Pass-Through Extension Cable (CE8CPF154) available – extends power capability beyond 208".

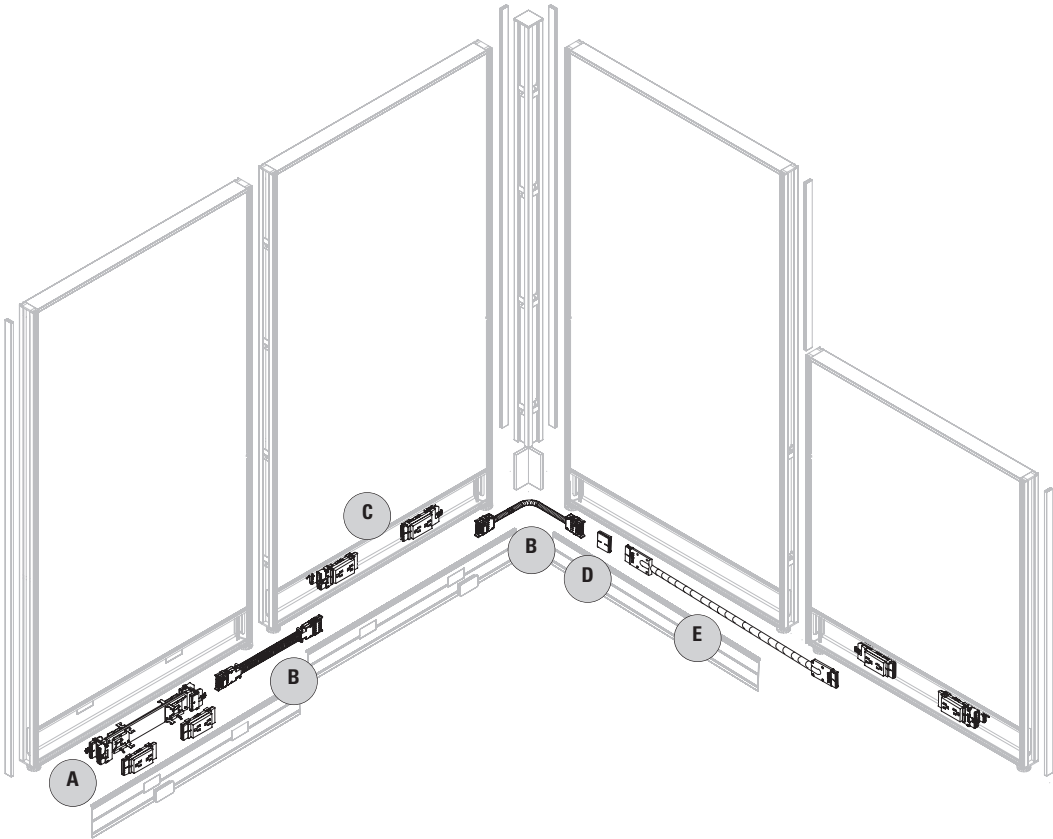

ELECTRICAL

E8PD - POWER DISTRIBUTION HOUSING

- Power housing is specified per panel size (e.g. CE8PD36 is for use in a 36" panel).
- 8 wire, 4 circuits (4th circuit dedicated).
- Power distribution housing is required for each powered panel, the power distribution housing should equal the width of the panel that it is specified in.
- Provides two duplex receptacle ports per panel side on all panel widths except the 24" wide panel.
- 24" wide panel allows for only one (1) duplex receptacle on one panel side.
- Each power distribution housing supports 15-20 amps.
- Must specify Raceway Cover with Knockouts on panels, where Power Distribution Housings will be utilized.

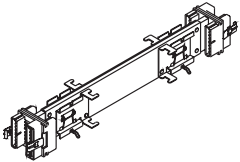
	DESCRIPTION	PRODUCT CODE	LIST PRICE	DIMENSIONS/INCHES		
				H	W	D
	Power Distribution Housing	QSCE8PD24	154	9 1/4		
		QSCE8PD30	209	15 1/4		
		QSCE8PD36	219	21 1/4		
		QSCE8PD42	224	27 1/4		
		QSCE8PD48	241	33 1/4		
		QSCE8PD60	244	45 1/4		

CE8CP17 - FLEXIBLE MESH JUMPER CABLE

- 17" mesh jumper.
- Jumper cable is used to pass through a post or connect two panels together.

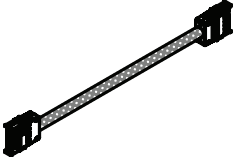
	DESCRIPTION	PRODUCT CODE	LIST PRICE	DIMENSIONS/INCHES		
				H	W	D
	Flexible Mesh Jumper Cable	QSCE8CP17	120	17		

ELECTRICAL

CE8CP - PASS THROUGH CABLE

- Flexible metal conduit is used to distribute electrical power through non-powered panels.
- Metal conduit pass through cables should be in used in a straight runs. Metal conduit pass through cables cannot pass through a post.
- Flexible conduit is required to turn a post. This only comes as 17" w. If panels at the posts do not all have power distribution housings, they must be added even if duplexes are not specified.
- To calculate the length of a Pass-Through Cable, add the widths of the non-powered panels separating the powered panels (panels with distribution housing attached). To this add 16" (distance from the edge of the panel to the distribution housing x 2).
- Add additional 3" when passing through a corner post. See the Tips at the beginning of the section for more details.

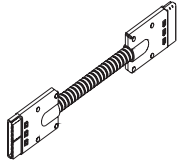
DESCRIPTION	PRODUCT CODE	LIST PRICE	DIMENSIONS/INCHES		
			H	W	D
 Pass Through Cable	QSCE8CP28	159	28	1/2	
	QSCE8CP40	167	40	1/2	
	QSCE8CP46	172	46	1/2	
	QSCE8CP52	178	52	1/2	
	QSCE8CP58	187	58	1/2	
	QSCE8CP64	197	64	1/2	
	QSCE8CP70	202	70	1/2	
	QSCE8CP76	205	76	1/2	
	QSCE8CP82	213	82	1/2	
	QSCE8CP88	219	88	1/2	
	QSCE8CP94	225	94	1/2	
	QSCE8CP100	231	100	1/2	

CE8CI-1 - "I" CONNECTOR

- Female - Female connector connects two Pass-Through Cables.
- Connects 17" Flexible Jumper Cable or ceiling feeds to pass through cables.

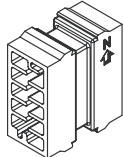
DESCRIPTION	PRODUCT CODE	LIST PRICE	DIMENSIONS/INCHES		
			H	W	D
 "I" Connector	QSCE8CI-1	88	1.5	1.5	

ELECTRICAL

CE8RD - DUPLEX RECEPTACLE

- Up to 3 receptacles per circuit
- Up to 6 receptacles per circuit (24 per infeed), not to exceed total of 15 Amps per circuit.
- Duplex Receptacles standard in Black (BLK).

- CE8RD1 = Circuit #1 (utility circuit)
- CE8RD2 = Circuit #2 (utility circuit)
- CE8RDA = Circuit A (dedicated)
- CE8RDB = Circuit B (dedicated)
- CE8RD1 and CE8RD2 (#1 and #2 share common ground)
- CE8RDA and CE8RDB (A and B share common ground)

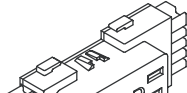
DESCRIPTION	PRODUCT CODE	LIST PRICE	DIMENSIONS/INCHES		
			H	W	D
 Duplex Receptacle	QSCE8RD1	33	2	4 5/8	1 1/4
	QSCE8RD2	33	2	4 5/8	1 1/4
	QSCE8RDA	33	2	4 5/8	1 1/4
	QSCE8RDB	33	2	4 5/8	1 1/4

CE8RDxca - CALIFORNIA CONTROLLED DUPLEX RECEPTACLE

- California Title 24 meets federal and LEED certification guidelines
- Allows circuit to be controlled or switched off when utility is not in use.
- Duplex receptacles are rated for 15 Amps.
- CE8RD1CA = Circuit #1 (utility circuit)
- CE8RD2CA = Circuit #2 (utility circuit)
- CE8RDACA = Circuit A (dedicated)
- CE8RDBCA = Circuit B (dedicated)

NOTE:

- CE8RD1CA and CE8RD2CA (#1 and #2 share common ground)
- CE8RDACA and CE8RDBCA (A and B share common ground)
- Up to 6 receptacles per circuit (24 per infeed), not to exceed total of 15 Amps per circuit.
- Available in BLK finish only.

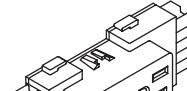
DESCRIPTION	PRODUCT CODE	LIST PRICE	DIMENSIONS/INCHES		
			H	W	D
 Duplex Receptacle	QSCE8RD1CA	38	2	4 5/8	1 1/4
	QSCE8RD2CA	38	2	4 5/8	1 1/4
	QSCE8RDACA	38	2	4 5/8	1 1/4
	QSCE8RDBCA	38	2	4 5/8	1 1/4

ELECTRICAL

CE8FR1 - REVERSIBLE FLOOR POWER ENTRY

- Takes the place of a duplex receptacle by snapping into the base power way.
- Includes 72" long flexible metal conduit.
- Must be hard wired to source power by a licensed electrician.
- Diameter is 0.85"

DESCRIPTION	PRODUCT CODE	LIST PRICE	DIMENSIONS/INCHES		
			H	W	D

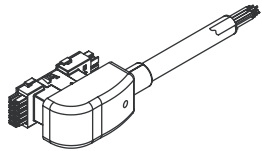

Reversible Floor Power Entry

QSCE8FR1

347

6

72

CE8F - FLOOR POWER ENTRY

- Snaps in end of power distribution housing.
- Includes flexible vinyl conduit.
- Must be hard wired to source power by a licensed electrician.
- Diameter is 0.85"

DESCRIPTION	PRODUCT CODE	LIST PRICE	DIMENSIONS/INCHES		
			H	L	D

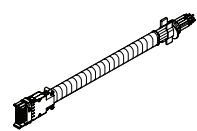

Reversible Floor Power Entry

QSCE8F1P
QSCE8F2P

357
461

72
144

CMEB01 - ELECTRICAL BOX - CHICAGO

- Can be retrofitted in any size of panel at the receptacle location.
- Gives access from one side only at each location.
- Customer to supply conduit, wiring, receptacle, and face plate.
- 2 per panel ,except 24" panel only one
- Note: A licensed electrician must provide hardware connection with the junction box.

DESCRIPTION	PRODUCT CODE	LIST PRICE	DIMENSIONS/INCHES		
			H	W	D

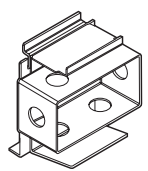

Electrical Box - Chicago

QSCMEB01

101

CMEB02NY - ELECTRICAL BOX - NEW YORK

- Shipped assembled.
- Comes with pig tail electric.
- Use with 30" wide Panel of larger
- Post extension cable capacities: without electric, 30 with electric, 20
- Includes ceiling bezel and screws.

DESCRIPTION	PRODUCT CODE	LIST PRICE	DIMENSIONS/INCHES		
			H	W	D

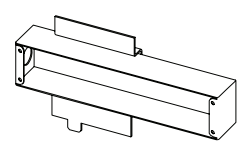

Electrical Box - New York

QSCMEB02NY

444

ELECTRICAL

CEPEXX - POST EXTENSION

- Same profile as post.
- Includes two post extension brackets, four screws and four trim inserts.
- Includes ceiling bezel and screws.

	DESCRIPTION	PRODUCT CODE	LIST PRICE	DIMENSIONS/INCHES		
				H	W	D
	Post Extension	QSCEPE64	192	64	2.3	2.3
		QSCEPE82	241	82	2.3	2.3

CE8ECX - CEILING FEED

- Snaps into the end of a Power Distribution Housing.
- Flexible metal conduit extends into the ceiling through a corner post and post extension.
- Must be hard wired to source power by a licensed electrician.
- 4" junction box included.
- Post extension ordered separately

	DESCRIPTION	PRODUCT CODE	LIST PRICE	DIMENSIONS/INCHES		
				H	W	D
	Ceiling Feed	QSCE8EC2	469	144		

CMECC - CABLE COVER

- Attaches to panels vertically between modules to provide enclosures for power or data cords.
- Available in Steel (STL), Black (BLK), Nevada (NEV) only.
- Available in 21" and 36" lengths, 6 per pack.

	DESCRIPTION	PRODUCT CODE	LIST PRICE	DIMENSIONS/INCHES		
				H	W	D
	Cord Cover	QSCMECC21	32	21	0.5	1
		QSCMECC36	50	36	0.5	1

ELECTRICAL

CMLEDES - STARTER LED TASK LIGHT

- Undercabinet slim profile LED linear light fixture with lens and On/Off switch.
- May be used as stand-alone or extended with add-on section below (CMLEDES_DSC).
- Plug-in power supply with 72" cord length plus 78" DC cable.
- Includes magnet mounting bracket with optional adhesive metal plate.
- Light enclosure in clear anodizing finish. Color temperature cool white 4000K.
- Lifespan rated 30,000 hours.

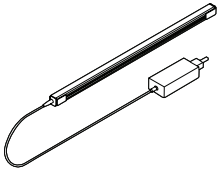
	DESCRIPTION	PRODUCT CODE	LIST PRICE	DIMENSIONS/INCHES		
				H	W	D
	Led Task Light	QSCMLEDES24	277	1	22.9	1
		QSCMLEDES36	318	1	33.5	1
		QSCMLEDES48	354	1	45.5	1

CMLEDES - ADD-ON LED TASK LIGHT

- Undercabinet slim profile LED linear add-on light fixture with lens.
- Daisy chain unit with 39" linking cable, no power supply.
- Add-on units can only be linked up to a total of 48 watts per power supply; this is equivalent to 10 feet of nominal length of light per power supply.
- Includes magnet mounting bracket with optional adhesive metal plate. Light enclosure in clear anodizing finish. Color temperature cool white 4000K. Lifespan rated 30,000 hours.

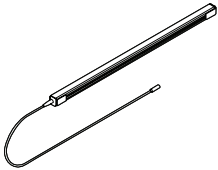
	DESCRIPTION	PRODUCT CODE	LIST PRICE	DIMENSIONS/INCHES		
				H	W	D
	Led Task Light	QSCMLEDES24DSC	227	1	22.9	39
		QSCMLEDES36DSC	267	1	33.5	39
		QSCMLEDES48DSC	303	1	45.5	39

CMLEDESOS - OCCUPANCY SENSOR

- Inline add-on controller for dimming and occupancy sensor.
- Sensor bypass switch.

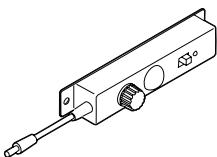
	DESCRIPTION	PRODUCT CODE	LIST PRICE	DIMENSIONS/INCHES		
				H	W	D
	Occupancy Sensor	QSCMLEDESOS	114	6	2.4	2



worksurfaces

The information listed below provides you with basic features of Compile Worksurfaces.

- Compile thermally fused Worksurfaces are 1" thick and are finished with 3 mm PVC edging on all sides.
- Worksurfaces are predrilled to enable proper alignment with worksurface supports.
- Standard laminate offerings are available in thermally-fused (T). See laminate listings for details.
- Laminate Worksurfaces will have matching woodgrain trim only.
- Depth of the Worksurface scoops are 1 1/8" when measured from the Panel the Worksurface is attached to.
- All Worksurfaces require support items. These are priced separately within this section.
- Grain Direction for Worksurfaces are as follows:

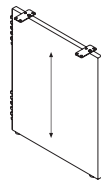

CHEP End Panels

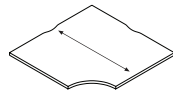

CWCC Worksurfaces

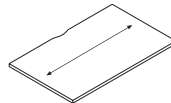

CWS Worksurfaces

- Communication and electrical wires are routed through a cable scoop located at the back of the Worksurface. When specifying a Straight Worksurface (CWS) or a Curvilinear Worksurface (CWVL), note that the number of cable scoops depends upon the width of the Worksurface. All other Worksurface shapes have one scoop on Panel edges.

**One Scoop
CWS 24" – 48"**



**Two Scoops
CWS 54" – 84"**



This page provides a three dimensional view of a sample configuration highlighting each **Worksurface** component required when specifying this configuration.

Components

- A. QSCWS2424P Rectangular Worksurface
- B. QSCWCC3624P Corner Curved Worksurface
- C. QSCWS2424P Rectangular Worksurface

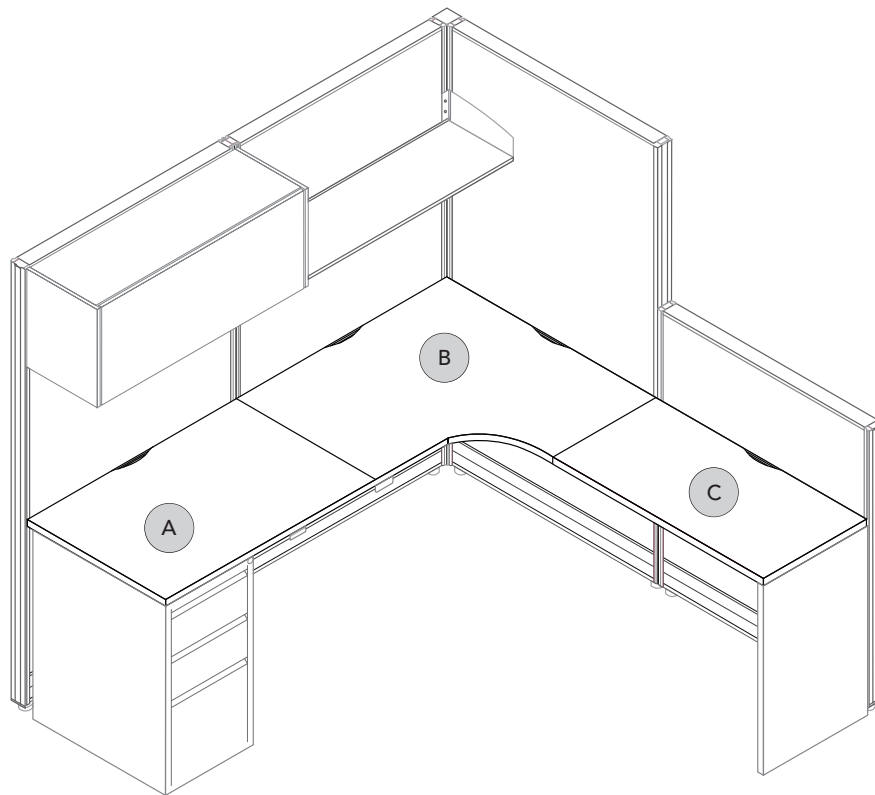

WORKSURFACES

CWS - RECTANGULAR WORKSURFACES

- All tops are thermally fused 1" thick with pilot holes to enable proper alignment with worksurface supports. Wood screws must be used.
- Compile worksurfaces feature a 3mm edge.
- Support hardware must be ordered separately. See the listings in this section.
- Width and depth dimensions listed include a nominal measurement (3/8") to account for wire management between the worksurface and adjoining panel.
- All surfaces over 48" will have two scoops, all others have one.
- Worksurfaces greater than 48" wide require additional structural support.

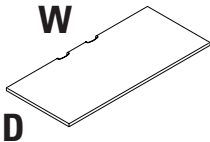
	DESCRIPTION	PRODUCT CODE	LIST PRICE	DIMENSIONS/INCHES	
				D	W
	Rectangular Worksurfaces - 24" Deep	QSCWS2424P	139	24	24
		QSCWS2430P	149	24	30
		QSCWS2436P	167	24	36
		QSCWS2442P	214	24	42
		QSCWS2448P	258	24	48
		QSCWS2454P	301	24	54
		QSCWS2460P	339	24	60
		QSCWS2466P	354	24	66
		QSCWS2472P	367	24	72
			Rectangular Worksurfaces - 30" Deep	QSCWS3024P	163
QSCWS3030P	173			30	30
QSCWS3036P	205			30	36
QSCWS3042P	288			30	42
QSCWS3048P	301			30	48
QSCWS3054P	330			30	54
QSCWS3060P	354			30	60
QSCWS3066P	366			30	66
QSCWS3072P	388			30	72



WORKSURFACES

CWCC - CORNER CURVED WORKSURFACES

- All tops are thermally fused 1" thick with pilot holes to enable proper alignment with worksurface supports. Wood screws must be used.
- Compile worksurfaces feature a 3mm edge.
- Support hardware must be ordered separately. See the listings in this section.
- Note: Width and depth dimensions listed include a nominal measurement (38") to account for wire management between the worksurface and adjoining panel.
- Note: Wood grain laminates do not run diagonally on corner worksurfaces.
- Worksurfaces greater than 48" wide require additional structural support.

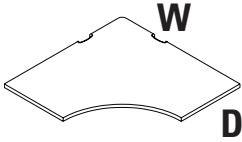
	DESCRIPTION	PRODUCT CODE	LIST PRICE	DIMENSIONS/INCHES	
				D	W
	Corner Curved Worksurfaces - 36"	QSCWCC3624P	511	24	36
	Corner Curved Worksurfaces - 42"	QSCWCC4224P QSCWCC4230P	689 750	24 30	42 42

WORKSURFACES

CWSNSCP - RECTANGULAR WORKSURFACE, NO SCOOPS FOR HEIGHT ADJUSTABLE BASES

- There is no scoop on this work surface.
- Worksurface depth is exact, not nominal.
- Support hardware must be ordered separately. See listing in this section of the price book.
- For use with Height Adjustable Bases
- Surfaces not available in HPW.

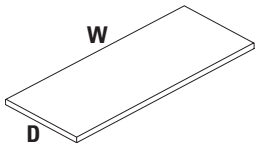
	DESCRIPTION	PRODUCT CODE	LIST PRICE	DIMENSIONS/INCHES		
				H	D	W
	Rectangular Worksurface No Scoops for Height Adjustable Bases	QSCWS2346NSCP	258	1	23	46
		QSCWS2352NSCP	301	1	23	52
		QSCWS2358NSCP	339	1	23	58
		QSCWS2364NSCP	354	1	23	64
		QSCWS2370NSCP	367	1	23	70
		QSCWS2946NSCP	301	1	29	46
		QSCWS2952NSCP	330	1	29	52
		QSCWS2958NSCP	354	1	29	58
		QSCWS2964NSCP	366	1	29	64
		QSCWS2970NSCP	388	1	29	70

WORKSURFACES

CHCB2 - CORNER BRACKET

- Attaches the corner of any worksurface to a panel connector.
- Priced and shipped in pairs.
- Available in standard Fog (FOG) or Designer White (DWT).
- Cannot be used off modular.
- Can be used when a panel is the same depth as the worksurface in the front and back application.

DESCRIPTION	PRODUCT CODE	LIST PRICE	DIMENSIONS/INCHES	
			D	W
 Corner Bracket	QSCHCB2	22	2.5	

CHWB1 - MID SPAN SUPPORT BRACKET

- Does not need to be on module.
- Used when a panel exceeds the depth of the adjacent worksurface.
- Can only be used with a Segmented Panel.
- Comes in unfinished zinc.

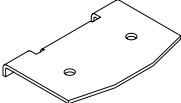
DESCRIPTION	PRODUCT CODE	LIST PRICE	DIMENSIONS/INCHES	
			D	W
 Mid Span Support Bracket	QSCHWB1	14		

CHC15 & CHC22- CANTILEVER

- Attaches a worksurface to a panel.
- Use one cantilever to support two convergent worksurfaces when specified with 3 Flat Brackets or two cantilevers with one flat bracket to support two convergent worksurfaces.
- Does not include Flat Brackets.
- Priced individually
- Specify handedness of each cantilever
- Available in standard Fog (FOG) or Designer White (DWT).
- Right and left Cantilever needs to be specified unless flat brackets are also specified.

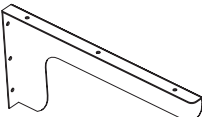
DESCRIPTION	PRODUCT CODE	LIST PRICE	DIMENSIONS/INCHES	
			D	W
 Cantilever - 15"	QSCHC15L	50	15	6
	QSCHC15R	50	15	6
Cantilever - 22"	QSCHC22L	77	22	6
	QSCHC22R	77	22	6

CMHC - WORKSURFACE SUPPORT CHANNEL

- Support channel attaches to underside of worksurface with screws
- Support channel should be 14" shorter than top length.
- Screws are included.
- Only available in Black.
- Tops with post legs should be specified with support channel for structural reinforcement.

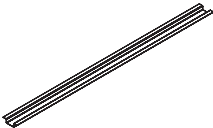
DESCRIPTION	PRODUCT CODE	LIST PRICE	DIMENSIONS/INCHES	
			L	D
 Worksurface Support Channel	QSCMHC40 - for 54" wide table	84	40	5
	QSCMHC46 - for 60" wide table	91	46	5
	QSCMHC52 - for 66" wide table	101	52	5
	QSCMHC58 - for 72" wide table	114	58	5
	QSCMHC64 - for 78" wide table	124	64	5
	QSCMHC70 - for 84" wide table	138	70	5

WORKSURFACES

CHFB1 - FLAT BRACKET

- Use in conjunction with Cantilever to make it a shared Cantilever to support convergent worksurfaces.
- Available in Black only.
- Used at the front of 2 convergent worksurfaces to keep worksurfaces flush at seams.

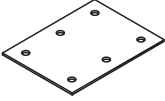
	DESCRIPTION	PRODUCT CODE	LIST PRICE	DIMENSIONS/INCHES	
				D	W
	Flat Bracket	QSCHFB1	21	3	4

CHEP - END PANEL

- Supports the worksurface and enhances the stability of connected panels.
- Provides solid support at the end of a run of worksurfaces.
- Finished in thermally-fused laminate.
- Includes flat brackets and hardware.
- End panel height is inclusive of panel glides extended to their fullest height.
- If wood grains is selected, grain runs vertically.

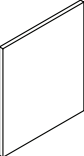
	DESCRIPTION	PRODUCT CODE	LIST PRICE	DIMENSIONS/INCHES	
				D	W
	End Panel - 28"High	QSCHEP2924	264	28	24
		QSCHEP2930	311	28	30

CHMEGR - METAL END GABLE - RIGHT

- Supports the worksurface and enhances the stability of connected panels.
- Available in standard Fog (FOG) or Designer White (DWT).
- Includes a levelling glide and decorative PVC sleeve to cover the glide.

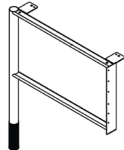
	DESCRIPTION	PRODUCT CODE	LIST PRICE	DIMENSIONS/INCHES		
				H	D	W
	Metal End Gable - Right	QSCHMEG24R	285	28	23	4
		QSCHMEG30R	300	28	29	4

CHMEGL - METAL END GABLE - LEFT

- Supports the worksurface and enhances the stability of connected panels.
- Available in standard Fog (FOG) or Designer White (DWT).
- Includes a levelling glide and decorative PVC sleeve to cover the glide.

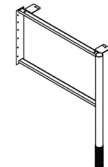
	DESCRIPTION	PRODUCT CODE	LIST PRICE	DIMENSIONS/INCHES		
				H	W	D
	Metal End Gable - Left	QSCHMEG24L	285	28	23	4
		QSCHMEG30L	300	28	29	4



WORKSURFACES

CHMSL - METAL SUPPORT LEG

- Supports two adjoining worksurfaces and enhances the stability of connected panels.
- Includes a levelling glide and decorative PVC sleeve to cover the glide.
- Available in standard Fog (FOG) or Designer White (DWT).
- Flat brackets recommended to ensure alignment of neighboring surface.

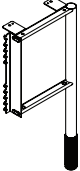
	DESCRIPTION	PRODUCT CODE	LIST PRICE	DIMENSIONS/INCHES		
				H	W	D
	Metal Support Leg	QSCHMSL12	239	28	11	4



CHMSL - MID SUPPORT LEG

- Provides support for a worksurface.
- Includes leveling glide, PVC Sleeve and 4.8" x 4.8" attachment plate.
- 1.5" diameter.
- Available in standard Fog (FOG) or Designer White (DWT).

	DESCRIPTION	PRODUCT CODE	LIST PRICE	DIMENSIONS/INCHES
				H
	Mid Support Leg - Round	QSCHMSL1	91	28
	Mid Support Leg - Square	QSCHMSL2	91	28

CMHCL & CHHCL - CORNER LEG WITH LEVELER

- Provides support for a worksurface.
- Includes leveling glide, PVC Sleeve and attachment plate.
- 1.5" diameter
- Available in standard Fog (FOG) or Designer White (DWT).
- Legs can be used in the corner of a single worksurface or be rotated 45 degrees to support the corners of two worksurfaces.

	DESCRIPTION	PRODUCT CODE	LIST PRICE	DIMENSIONS/INCHES
				H
	Corner Leg Round	QSCMHCL1	127	28
	Corner Leg Square	QSCMHCL2	127	28

WORKSURFACES

CHWS - 5" SURFACE TO STORAGE SUPPORT LEG

- Provides support for a worksurface.
- Includes leveling glide, PVC Sleeve and 4.8" x 4.8" attachment plate.
- 1.5" diameter.
- Available in standard Fog (FOG) or Designer White (DWT).

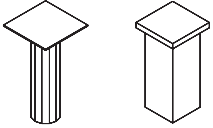
	DESCRIPTION	PRODUCT CODE	LIST PRICE	DIMENSIONS/INCHES H
	5" Surface to Storage Support Leg - Round	QSCHWSRL01	59	4.5
	5" Surface to Storage Support Leg - Square	QSCHWSSL01	59	4.5

PEDESTAL FILLER BRACKET

- Screws to back of pedestal
- Fills the gap between the pedestal and panel when wing panel is not used.
- Available in standard Fog (FOG) or Designer White (DWT).

DESCRIPTION	PRODUCT CODE	LIST PRICE	DIMENSIONS/INCHES D W	
Pedestal Filler Bracket-	QSCHPBF	60	26.875	1.375

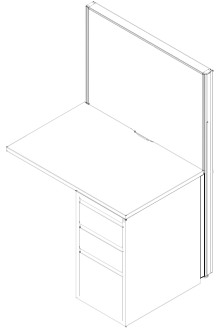

storage

LATERAL FILE FEATURES

DRAWERS/SHELVES

- Drawer interlocking system
- Three-stage, anti-bounceback suspension
- Pre-installed, side-to-side file bars for letter, legal and A4
- Front-to-back file bars – optional
- Full-height dividers – optional
- Angled full pull

CONSTRUCTION

- Top stiffener bar
- Corner gussets
- Four (4) ganging drill points are marked to ensure correct positioning
- Cam lock included
- Leveling glides
- Counterweights are included in 2, 3 and 4 drawer cabinets. BIFMA does not require counterweight in 5 drawer cabinets.

PEDESTAL FEATURES

DRAWERS/SHELVES

- All drawer fronts feature a recessed, angled full pull.
- Drawers feature ball bearing suspension.

CONSTRUCTION

- Central Core removable cam locks.
- Pedestals are 15" wide.
- Counterweight is standard on all Freestanding models.
- Worksurfaces supporting models have holes drilled in top to attach underneath a worksurface.

STANDARD PAINT COLORS

DESIGNER WHITE DWT

FOG FOG

GENERAL WARRANTY INFORMATION

- Evolve warrants all components of metal storage and filing for the lifetime of the product to the original purchaser.



This page provides a three dimensional view of a sample configuration highlighting each **Worksurface** component required when specifying this configuration.

Components

- A. QSCWS2424P Rectangular Worksurface
- B. QSCWCC3624P Corner Curved Worksurface
- C. QSCWS2424P Rectangular Worksurface

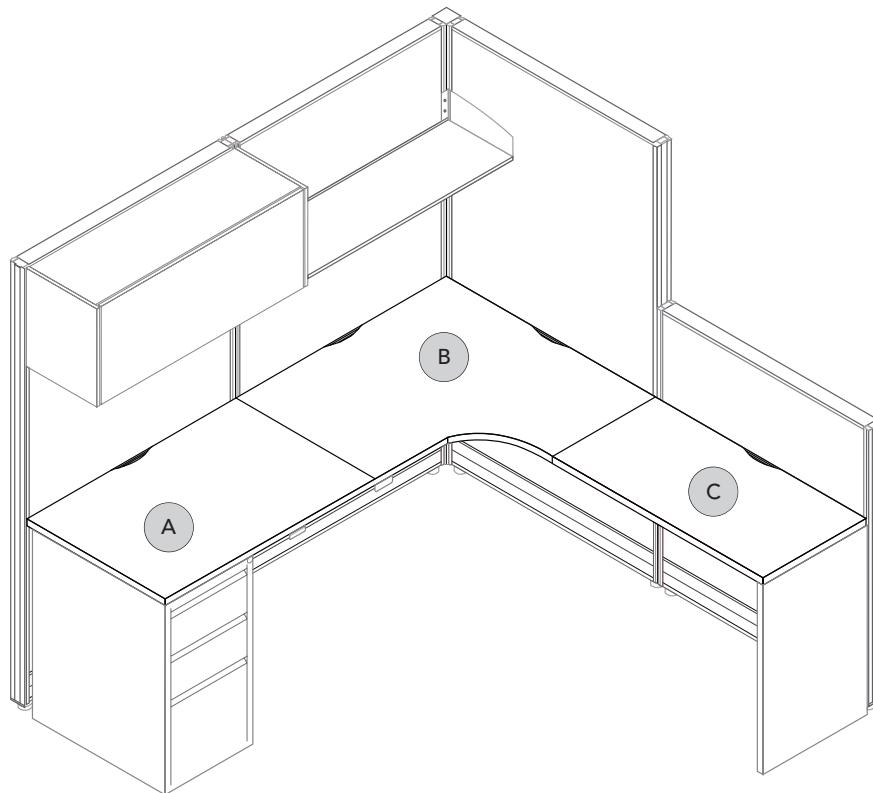

STORAGE

CS19XXBBF - WORKSURFACE SUPPORTING BOX/BOX/FILE 15" PEDESTAL

- Worksurface supporting, with predrilled holes in the top.
- Also available as freestanding with finished top.
- All drawer fronts feature a recessed, angled full pull.
- Pedestal height shown includes glide.
- Pencil tray and Lock included.
- File Bars are not included with Compile pedestals. To order file bars, use product code CSPEDHFB at \$15.00 each list.

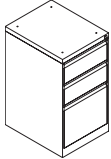
	DESCRIPTION	PRODUCT CODE	LIST PRICE	DIMENSIONS/INCHES		
				H	D	W
	Worksurface Supporting Box/Box/File 15" Pedestal	QSCS1923BBF	565	27.58	22.58	15

CS19XXFF - WORKSURFACE SUPPORTING FILE/FILE 15" PEDESTAL

- Worksurface supporting, with predrilled holes in the top.
- Also available as freestanding with finished top.
- All drawer fronts feature a recessed, angled full pull.
- Pedestal height shown includes glide.
- Lock included.
- File Bars are not included with Compile pedestals. To order file bars, use product code CSPEDHFB at \$15.00 each list.

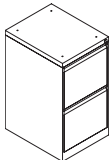
	DESCRIPTION	PRODUCT CODE	LIST PRICE	DIMENSIONS/INCHES		
				H	D	W
	Worksurface Supporting File/File 15" Pedestal	QSCS1923FF	565	27.58	22.58	15.5

CSMCPXXBFNC - MOBILE BOX/FILE PEDESTAL WITH 60MM CASTERS

- Mobile pedestal that includes one pencil tray.
- Includes factory installed counterweight.
- Lock is standard.
- 60mm high castors.
- For use with pedestal seat cushion. See model below.
- Casters do not lock.

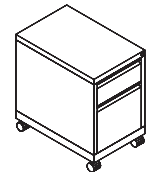
	DESCRIPTION	PRODUCT CODE	LIST PRICE	DIMENSIONS/INCHES		
				H	D	W
	Mobile Box/File Pedestal with 60mm Castors	QSCMCP23BFNC	829	23.78	22.58	15



STORAGE

CSSL13 - LOW PROFILE SHELF

- 13" deep panel-mounted storage shelf with backlip.
- Mounting brackets are included.

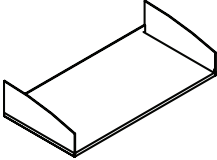
DESCRIPTION	PRODUCT CODE	LIST PRICE	DIMENSIONS/INCHES		
			H	D	W
 Low Profile Shelf - 13"	QSCSSL1330	150	5	13	30
	QSCSSL1336	163	5	13	36
	QSCSSL1342	175	5	13	42
	QSCSSL1348	184	5	13	48

CSOF13 - KD OVERHEAD

- Mounting brackets are included.
- Door retracts up and over the cabinet.
- Ready for quick assembly on site.
- Quality steel construction.
- 60" unit is reinforced for proper weight distribution.
- Inside dimensions: 12" h x 12.75" d

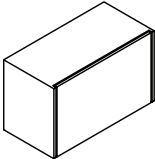
DESCRIPTION	PRODUCT CODE	LIST PRICE	DIMENSIONS/INCHES		
			H	D	W
 KD Overhead - 13"	QSCSOF1330	392	14.5	13	30
	QSCSOF1336	432	14.5	13	36
	QSCSOF1342	457	14.5	13	42
	QSCSOF1348	483	14.5	13	48

CMSLK13 - LOCK FOR KD OVERHEAD

- Must be specified separately.

DESCRIPTION	PRODUCT CODE	LIST PRICE	DIMENSIONS/INCHES		
			H	D	W
 Lock for KD Overhead	QSCMSLK13	44			

CSLOCKKEY - CORE AND KEY

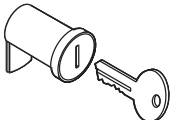
DESCRIPTION	PRODUCT CODE	LIST PRICE	DIMENSIONS/INCHES		
			H	D	W
 LOCKKEY - Core and Key	QSCSLOCKKEY	42			

STORAGE

CS19XXP - 2F12 - LATERAL FILES - 2 DRAWERS WITH COUNTERWEIGHT

- Counterweight is standard. Two fixed front drawers.
- Side-to-side hanging file bars included.
- Drawers are 12.25" high.
- File cannot be used to store standard three ring binders.
- Lock included.

	DESCRIPTION	PRODUCT CODE	LIST PRICE	DIMENSIONS/INCHES		
				H	D	W
	Lateral Files - 2 Drawers	QSCS1930P-2F12	985	27.14	19.25	30
	with Counterweight	QSCS1936P-2F12	1061	27.14	19.25	36



LAMINATES – THERMALLY FUSED & HIGH PRESSURE

Absolute Acajou	ACJ
Custom Grey	CGY
Designer White.....	DWT
White Chocolate.....	WHC

PVC EDGE TRIM

Absolute Acajou	AAE
Designer White.....	DWE
Silver	SIL
White Chocolate.....	CBE

PAINT & FRAME COLORS

(for application to trim, steel components, PVC, vertical and horizontal members)
 Designer White..... **DWT**
 Fog..... **FOG**

WORKSURFACE SCOOPS

Black.....	BLK
Silver	SIL
White.....	DWT

PET FELT FINISHES

Graphite.....	GPH
Mist.....	MTS
Pewter.....	PWT

PANEL FABRICS – GRADE 1

Aurora - 100% Polyester, 80% minimum Post-Consumer Recycled Polyester

Cloud	AU20
Seal	AU21
Fog	AU22
Pewter	AU23
Granite.....	AU24
Oat	AU25
Coconut	AU26
Latte	AU27
Lake	AU28
Frost.....	AU29

Merge - 100% Polyester, 75% minimum Post-Consumer Recycled Polyester

Fawn.....	MG20
Marshmallow	MG21
Driftwood	MG22
Dove	MG23
Graphite.....	MG24
Slate	MG25
Eucalyptus	MG26
Fire Engine.....	MG27
Mediterranean	MG28
Midnight.....	MG29



TERMS & CONDITIONS

APPLICATION OF STANDARD TERMS

Sales of Evolve products are made only on Evolve standard terms and conditions of sale which are contained in the Price Book and in Evolve's order acknowledgments. These standard terms and conditions may be modified or supplemented only by a separately written document signed by Evolve's authorized personnel at its head office in Marlton, New Jersey. An offer by Purchaser of said terms and conditions shall not be binding until accepted by Evolve in writing.

All illustrations, specifications and prices in this Price List are based on the latest product information available at the time of publication. Evolve reserves the right to make changes, at any time and without prior notice, to prices, colors, materials, specifications and models offered.

PRICES AND PAYMENT

The prices shown in this Price List, as well as those quoted by Evolve, shall be in US dollars for orders shipped to destinations within the continental United States.

Prices listed herein are for standard product. Quotations for special product are available through Evolve Customer Support Department in Marlton, New Jersey.

Not included in the list price are special or export packing, unpacking and installation. Orders are invoiced at the time of shipment. The Customer agrees to pay a charge of 2% per month of invoices outstanding more than 30 days.

FOR PAYMENTS ONLY, MAIL TO:

Evolve Furniture Group, a division of:
Global Industries, Inc.
17 West Stow Road
P.O. Box 562
Marlton, New Jersey 08053

Any products sold shall remain the property of Evolve until fully paid for in cash. The Purchaser agrees to perform all acts which may be necessary to perfect and assure retention of title to such products to Evolve until such time as the goods have been paid for in full.

Freight charges will be prepaid by Evolve to destinations within the contiguous United States on shipments of \$10,000 list and greater. For shipments less than \$10,000 list, the freight charge will be 5% of the total list price.

Please note exception below:

All showroom and mock-up orders will be subject to actual freight charges.

Evolve shall, in its sole discretion, determine the most appropriate method of shipment routing and carrier. Shipments of less than a full trailer load (LTL) shall ship via common carrier. **These LTL shipments are not subject to specific delivery days or times.** Full trailer loads will provide for dedicated delivery time and schedule. Purchaser may request special packaging or method of shipment at Purchaser's sole expense.

TAXES

All sales, use, excise and other applicable taxes and the collection and reporting thereof (excluding only taxes on the net income of Evolve) are the Purchaser's responsibility and will be invoiced to the Purchaser. If Purchaser claims an exemption from such taxes, it shall be the Purchaser's responsibility to furnish an appropriate exemption certificate to Evolve.

ORDER INFORMATION

Evolve requires that **all orders be submitted electronically** to avoid errors and/or duplication. Orders will be acknowledged with Evolve's acknowledgement forms governing the transaction. The details appearing on the acknowledgement will describe the items to be shipped to Purchaser who must ascertain that they are correct. If not correct, Purchaser should notify Evolve immediately by telephone or fax followed by written confirmation. Acknowledgment shows approximate shipping date of items ordered. **Shipping dates are assigned to orders based on the item having the longest manufacturing lead time.** Orders with missing or incorrect information (finish selections, fabric selections, etc.) will be scheduled for manufacturing upon receipt correct complete information. Purchaser must indicate if multiple shipping schedules are required including noting if the shipping date requested is longer than standard posted lead time. Each shipment will be invoiced at time of shipping and will be subject to payment terms described herein.

CHANGES AND CANCELLATION

The order may not be changed or cancelled by Purchaser without the written consent of Evolve. This charge can be as much as 100% based upon proximity to scheduled shipment date. Special order items and fabric-covered items already in production are not subject to change or cancellation under any circumstances. Fabric-covered items are considered to be in production once the fabric has been cut.

SUSPENSION

In the event that the Purchaser defaults in the payment of any sum due Evolve, or in the event the Purchaser's financial condition becomes unsatisfactory to Evolve, Evolve shall have the right at its option, upon written notice to the Purchaser, to cancel shipment of any goods, unless within ten (10) days of Purchaser's receipt of such notice Purchaser provides assurance of payment to Evolve in such form, content and/or amounts as Evolve, in its sole discretion, deems adequate.

CODE RESTRICTIONS

Evolve portable furniture may be subject to local fire, electrical and/or building codes applicable to portable furniture. It shall be Purchaser's sole responsibility for the proper application of Evolve items within the limitations of such local codes, which may be different from area to area.

SERVICE

Service problems shall be handled by the authorized Evolve dealer. Where this cannot be accomplished on a local level, service problems should be referred to:

Evolve Furniture Group
Customer Support
17 West Stow Road
Marlton, New Jersey USA 08053
856-552-4000 888-827-2500
Attention: Evolve Operations Manager



TERMS & CONDITIONS

STORAGE

In the event Purchaser requests postponement of delivery beyond the acknowledged shipping date, Evolve may transfer the goods to storage on Purchaser's account and at Purchaser's risk and expense subject to a daily storage rate. Such transfer to storage shall be deemed shipment to Purchaser for all purposes, including invoicing and payment.

DELAYS

Evolve's order acknowledgement will state a shipping date which is Evolve's best estimate at the time the order is acknowledged. However, Evolve shall not incur any obligation or liability to Purchaser for failure to ship by a specified date. In addition, Evolve shall not be liable for any loss or damage resulting from any delay or failure in shipment or other failure to perform all or any part of the agreement between the parties with respect to the goods shown on the face of the order acknowledgement where such delay, failure, loss or damage is the proximate result of any act of any governmental authority or political subdivision thereof, revolution, riot, civil disorder or disturbance, act of enemies, delay or default in transportation, strike disputes among or between unions or other labor disputes, delay or inability in obtaining materials and facilities, fire, flood, act of God or any cause not within the reasonable control of Evolve, whether of the class of causes enumerated or otherwise. Without limiting the generality of the foregoing, Evolve may, without causing any breach or incurring liability, allocate goods which are in short supply, regardless of the reasons therefore, among purchasers, in any manner which Evolve, in its sole discretion, deems advisable.

BACK CHARGES

Evolve will not accept charges for expense incurred by the Purchaser in expediting shipments or otherwise. Evolve will not accept charges for the repair of damage by others.

CLAIMS

All goods are sold F.O.B. Toronto, Canada, unless otherwise agreed to in writing by Evolve. Evolve is not responsible for damage which occurs in transit or in storage. The carrier signs for all goods received in good order. It is the Purchaser's responsibility to examine goods upon receipt and to file any claims with the carrier. Any claims made against Evolve for apparent defects, errors or shortages must be made by the Purchaser in writing, within fifteen (15) working days after any delivery. Failure by the Purchaser to make any claim against Evolve within the above-described fifteen days shall constitute acceptance of the goods and a waiver of any apparent defects, errors or shortages.

RETURNS

No returns of goods will be accepted without written consent and shipping instructions, including Evolve's Return Goods Authorization (R.G.A.) numbers, to Evolve. A minimum restocking charge of 35% is made on all authorized returns for credit or refund, provided goods are received by Evolve in the condition in which they left the factory. No credit will be given if goods cannot be reused. Special order items and fabric-covered items are in no event subject to return. All returns must be approved and authorized in writing by Evolve Customer Support, Marlton, New Jersey.

LIFETIME WARRANTY

Evolve warrants that all commercial products are free from defects in material and workmanship, for the life of the product, to the original purchaser. This warranty is made by Evolve only to original customers acquiring the product directly from Evolve's authorized dealers. The customer's sole remedy pursuant to this warranty is limited to repair or replacement of parts or product at Evolve's option. Consent from Evolve must be obtained before any warranty work is performed. This warranty shall not apply to any products which must be replaced because of normal wear and tear, negligence, abuse or "accident", shipping damage, or product use and installation other than in accordance with written instructions or warnings. It shall also not apply when product has been modified or altered, repaired or refurbished by someone other than Evolve or an authorized dealer or because of natural variations over which Evolve has no control. In the event of repair and/or replacement of any defective product, Evolve does not warrant matching color, grain, texture or dye lots. Evolve's warranty does not cover the cost of transportation or labor. Repair or replacement will be at Evolve's option. Evolve makes no warranty that any of its products are suitable for any particular purpose and makes no other warranties, expressed or implied, other than those set forth in this Price List. As codes and standards vary from one jurisdiction to another, references to compliance are solely for convenience and without any representation as to accuracy or suitability. Users must verify the suitability of such information or product for their specific application. In no event shall Evolve be liable in either tort or contract for any loss or direct, special, incidental, consequential, or exemplary damages.

This Lifetime Warranty is NOT applicable to customers who use Evolve products for rental purposes and is effective only for products, parts or components manufactured after January 1, 2011.

Exceptions to this warranty include:

- Global fabrics and wood veneers, which are warranted for five years from date of delivery.
- Electrical components, which are warranted for ten years from the date of delivery.
- Moving parts such as glides, slides, casters, user-adjustable worksurface mechanisms, which are warranted for five years from date of delivery.

- Fading on fabric and wood veneers can be caused by exposure to U.V. rays/sunlight. Natural wood veneer, being a natural material, will have shade differences between veneer sheers, the difference will be more apparent between dye lots.

Evolve does not warrant color fastness on Customer's Own Material.

Because of natural variations over which Evolve has no control, this warranty does not extend to color, grain or texture of wood, and Evolve does not warrant matching of color, grain or texture.

Evolve makes no warranties, including implied warranties of merchantability and fitness for a particular purpose, other than the express warranties contained herein.

LIMITATION OF REMEDY

Purchaser's sole and exclusive remedy (excluding the repair or replacement of goods for breach of the express warranty above) for any matter or claim arising under or relating to these terms and conditions, the goods covered hereby and any transaction involving or relating to such goods, whether in contract, tort (including negligence) or otherwise, shall be payment of the lesser of the cost to repair or replace said product or the purchase price for the goods to which the claim relates. In no event shall Evolve be liable for any special, indirect, consequential, or incidental damages, including without limitation, damages for loss of business profits, business interruptions, or loss of information.

EVOLVE'S WARRANTY DOES NOT APPLY (FOR ANY PRODUCT CATEGORY) TO THE FOLLOWING:

- Failures due to wear and tear
- Failures which result from negligence, abuse, accident or misuse
- Failure to apply, install or maintain products according to Evolve's written instructions and warnings
- Modifications, attachments or repair methods not approved by Evolve
- Damage caused by a carrier in transit, or delivery/installation contractors
- The matching of colors, grains or textures (wood, leather, etc.) of natural materials and color matching of textiles
- Products exposed to extreme hot or cold temperatures or excessively dry or humid environments
- Colorfastness or the matching of color of textiles
- Damage by markings or staining; damage by sharp objects or imprinting from instruments
- Damage to textiles or laminate and wood surfaces/edges from exposure to sunlight (including UV rays)
- Products used for rental purposes

Evolve's warranty applies to products sold within the United States of America, Mexico, the Commonwealth of Puerto Rico and Canada.

showrooms and distribution centers throughout the united states

SHOWROOMS

Atlanta

10 10th Street
Suite 150
Atlanta, GA 30309
T (404) 879-0998

Chicago

The Merchandise Mart
10th Floor, Suite 1035
Chicago, IL 60654
T 312.755.0843

Miami

112 NE 41st Street
6th floor
Miami, FL 33137

New York City

386 Park Avenue South,
7th floor
New York, NY 10016
T 212.545.9900

Phoenix

4675 East Cotton
Center Boulevard,
Suite 165
Phoenix, AZ 85040
T 602.426.0666

Boston

One Harbor Street,
Suite 104
Boston, MA 02210
T 617.406.5435

Irvine

18400 Von Karman Ave.
Suite 100
Irvine, CA 92618

New Jersey (Southern)

119 Greentree Road
Marlton, NJ 08053
T 856.596.3390

Philadelphia

1735 Market Street
38th Floor
Philadelphia PA, 19103
215.861.0963

Washington, DC

1130 Connecticut
Avenue
Washington, DC 20036
T 202.659.0230

SHOWROOMS + DISTRIBUTION CENTERS

Atlanta Area

6715 Maple Ave.
Suite 100
Buford, GA 30518
T 678.602.4130

Cincinnati Area

8712 LeSaint Drive
Fairfield, OH 45014
T 513.777.0009

Ft. Lauderdale Area

560 Sawgrass
Corporate Parkway
Sunrise, FL 33325
T 954.846.8888

Los Angeles Area

12320 Bloomfield
Avenue, Unit A
Santa Fe Springs, CA
90670
T 562.484.9686

Baltimore Area

Troy Hill Corporate
Center
7030 Troy Hill Drive
Elkridge, MD 21075
T 410.379.8021

Dallas Area

2025 W. Beltline Rd.,
#100
Carrollton, TX 75006
T 972.236.1366

Houston

7865 Northcourt Road,
Building D, Suite 200
Houston, TX 77040
T 713.695.5777

Seattle Area

Oakesdale Commerce
Center
820 Southwest 34th St.
Building W7, Suite A
Renton, WA 98057
T 425.291.9282

Chicago Area

27W501 North Avenue
West Chicago, IL 60185
T 630.681.2818

Denver Area

16401 E. 33rd Dr., Ste. 50
Aurora, CO 80011
T 303.340.1617

Kansas Area

11617 West 81st Street
Lenexa, KS 66214
T 913.310.9963

Tampa Area

10351 Windhorst Road
Tampa, FL 33619
T 813.621.6272

Global - USA Headquarters

17 West Stow Road P.O. Box 562
Marlton, New Jersey U.S.A. 08053
Tel (856) 596-3390 (800) 220-1900
Fax (856) 596-5684
www.globalfurnituregroup.com

Global - Canada Headquarters

1350 Flint Road
Downsview, ON Canada M3J 2J7
Sales & Marketing: Tel (1-877) 446-2251
Customer Service: Fax (800) 361-3182
Government Customer Service: Fax (416) 739-6319

