

storage

LATERAL FILE FEATURES

DRAWERS/SHELVES

- Drawer interlocking system
- Three-stage, anti-bounceback suspension
- Pre-installed, side-to-side file bars for letter, legal and A4
- Front-to-back file bars – optional
- Full-height dividers – optional
- Angled full pull

CONSTRUCTION

- Top stiffener bar
- Corner gussets
- Four (4) ganging drill points are marked to ensure correct positioning
- Cam lock included
- Leveling glides
- Counterweights are included in 2, 3 and 4 drawer cabinets. BIFMA does not require counterweight in 5 drawer cabinets.

PEDESTAL FEATURES

DRAWERS/SHELVES

- All drawer fronts feature a recessed, angled full pull.
- Drawers feature ball bearing suspension.

CONSTRUCTION

- Central Core removable cam locks.
- Pedestals are 15" wide.
- Counterweight is standard on all Freestanding models.
- Worksurfaces supporting models have holes drilled in top to attach underneath a worksurface.

STANDARD PAINT COLORS

DESIGNER WHITE DWT

FOG FOG

GENERAL WARRANTY INFORMATION

- Evolve warrants all components of metal storage and filing for the lifetime of the product to the original purchaser.

This page provides a three dimensional view of a sample configuration highlighting each **Worksurface** component required when specifying this configuration.

Components

- A. QSCWS2424P Rectangular Worksurface
- B. QSCWCC3624P Corner Curved Worksurface
- C. QSCWS2424P Rectangular Worksurface

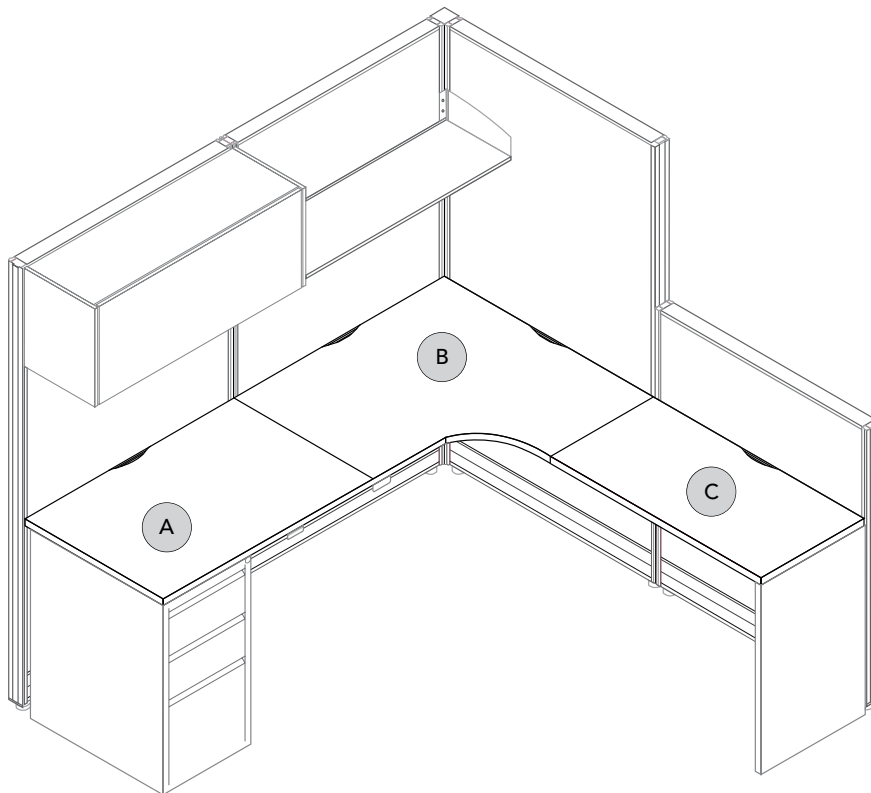

STORAGE

CS19XXBBF - WORKSURFACE SUPPORTING BOX/BOX/FILE 15" PEDESTAL

- Worksurface supporting, with predrilled holes in the top.
- All drawer fronts feature a recessed, angled full pull.
- Pedestal height shown includes glide.
- Pencil tray and Lock included.
- File Bars are not included with Compile pedestals. To order file bars, use product code CSPEDHFB at \$15.00 each list.

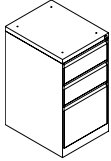
| | DESCRIPTION | PRODUCT CODE | LIST PRICE | DIMENSIONS/INCHES | | |
|---|--|--------------|------------|-------------------|-------|----|
| | | | | H | D | W |
|  | Worksurface Supporting Box/Box/File 15" Pedestal | QSCS1923BBF | 605 | 27.58 | 22.58 | 15 |

CS19XXFF - WORKSURFACE SUPPORTING FILE/FILE 15" PEDESTAL

- Worksurface supporting, with predrilled holes in the top.
- All drawer fronts feature a recessed, angled full pull.
- Pedestal height shown includes glide.
- Lock included.
- File Bars are not included with Compile pedestals. To order file bars, use product code CSPEDHFB at \$15.00 each list.

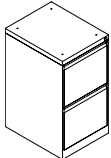
| | DESCRIPTION | PRODUCT CODE | LIST PRICE | DIMENSIONS/INCHES | | |
|---|---|--------------|------------|-------------------|-------|------|
| | | | | H | D | W |
|  | Worksurface Supporting File/File 15" Pedestal | QSCS1923FF | 605 | 27.58 | 22.58 | 15.5 |

CSMCPXXBFNC - MOBILE BOX/FILE PEDESTAL WITH 60MM CASTERS

- Mobile pedestal that includes one pencil tray.
- Includes factory installed counterweight.
- Lock is standard.
- 60mm high castors.
- For use with pedestal seat cushion. See model below.
- Casters do not lock.

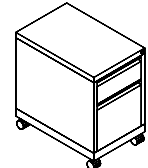
| | DESCRIPTION | PRODUCT CODE | LIST PRICE | DIMENSIONS/INCHES | | |
|---|--|--------------|------------|-------------------|-------|----|
| | | | | H | D | W |
|  | Mobile Box/File Pedestal with 60mm Castors | QSCMCP23BFNC | 888 | 23.78 | 22.58 | 15 |

STORAGE

CSSL13 - LOW PROFILE SHELF

- 13" deep panel-mounted storage shelf with backlip.
- Mounting brackets are included.

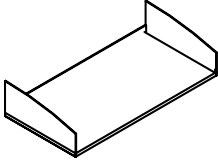
| | DESCRIPTION | PRODUCT CODE | LIST PRICE | DIMENSIONS/INCHES | | |
|---|-------------------------|--------------|------------|-------------------|----|----|
| | | | | H | D | W |
|  | Low Profile Shelf - 13" | QSCSSL1330 | 161 | 5 | 13 | 30 |
| | | QSCSSL1336 | 175 | 5 | 13 | 36 |
| | | QSCSSL1342 | 188 | 5 | 13 | 42 |
| | | QSCSSL1348 | 197 | 5 | 13 | 48 |

CSOF13 - KD OVERHEAD

- Mounting brackets are included.
- Door retracts up and over the cabinet.
- Ready for quick assembly on site.
- Quality steel construction.
- 60" unit is reinforced for proper weight distribution.
- Inside dimensions: 12" h x 12.75" d

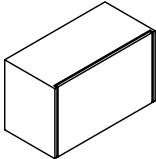
| | DESCRIPTION | PRODUCT CODE | LIST PRICE | DIMENSIONS/INCHES | | |
|---|-------------------|--------------|------------|-------------------|----|----|
| | | | | H | D | W |
|  | KD Overhead - 13" | QSCSOF1330 | 420 | 14.5 | 13 | 30 |
| | | QSCSOF1336 | 463 | 14.5 | 13 | 36 |
| | | QSCSOF1342 | 489 | 14.5 | 13 | 42 |
| | | QSCSOF1348 | 517 | 14.5 | 13 | 48 |

CMSLK13 - LOCK FOR KD OVERHEAD

- Must be specified separately.

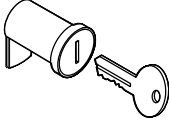
| | DESCRIPTION | PRODUCT CODE | LIST PRICE | DIMENSIONS/INCHES | | |
|---|----------------------|--------------|------------|-------------------|---|---|
| | | | | H | D | W |
|  | Lock for KD Overhead | QSCMSLK13 | 48 | | | |

CSLOCKKEY - CORE AND KEY

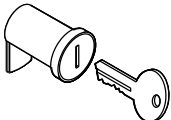
| | DESCRIPTION | PRODUCT CODE | LIST PRICE | DIMENSIONS/INCHES | | |
|---|------------------------|--------------|------------|-------------------|---|---|
| | | | | H | D | W |
|  | LOCKKEY - Core and Key | QSCSLOCKKEY | 45 | | | |

STORAGE

CS19XXP - 2F12 - LATERAL FILES - 2 DRAWERS WITH COUNTERWEIGHT

- Counterweight is standard. Two fixed front drawers.
- Side-to-side hanging file bars included.
- Drawers are 12.25" high.
- File cannot be used to store standard three ring binders.
- Lock included.

| | DESCRIPTION | PRODUCT CODE | LIST PRICE | DIMENSIONS/INCHES | | |
|---|---------------------------|----------------|------------|-------------------|-------|----|
| | | | | H | D | W |
|  | Lateral Files - 2 Drawers | QSCS1930P-2F12 | 1054 | 27.14 | 19.25 | 30 |
| | with Counterweight | QSCS1936P-2F12 | 1136 | 27.14 | 19.25 | 36 |