

storage

LATERAL FILE FEATURES

DRAWERS/SHELVES

- Drawer interlocking system
- Three-stage, anti-bounceback suspension
- Pre-installed, side-to-side file bars for letter, legal and A4
- Front-to-back file bars – optional
- Full-height dividers – optional
- Angled full pull

CONSTRUCTION

- Top stiffener bar
- Corner gussets
- Four (4) ganging drill points are marked to ensure correct positioning
- Cam lock included
- Leveling glides
- Counterweights are included in 2, 3 and 4 drawer cabinets. BIFMA does not require counterweight in 5 drawer cabinets.

PEDESTAL FEATURES

DRAWERS/SHELVES

- All drawer fronts feature a recessed, angled full pull.
- Drawers feature ball bearing suspension.

CONSTRUCTION

- Central Core removable cam locks.
- Pedestals are 15" wide.
- Counterweight is standard on all Freestanding models.
- Worksurfaces supporting models have holes drilled in top to attach underneath a worksurface.

STANDARD PAINT COLORS

DESIGNER WHITE DWT

FOG FOG

GENERAL WARRANTY INFORMATION

- Evolve warrants all components of metal storage and filing for the lifetime of the product to the original purchaser.



This page provides a three dimensional view of a sample configuration highlighting each **Worksurface** component required when specifying this configuration.

Components

- A. QSCWS2424P Rectangular Worksurface
- B. QSCWCC3624P Corner Curved Worksurface
- C. QSCWS2424P Rectangular Worksurface

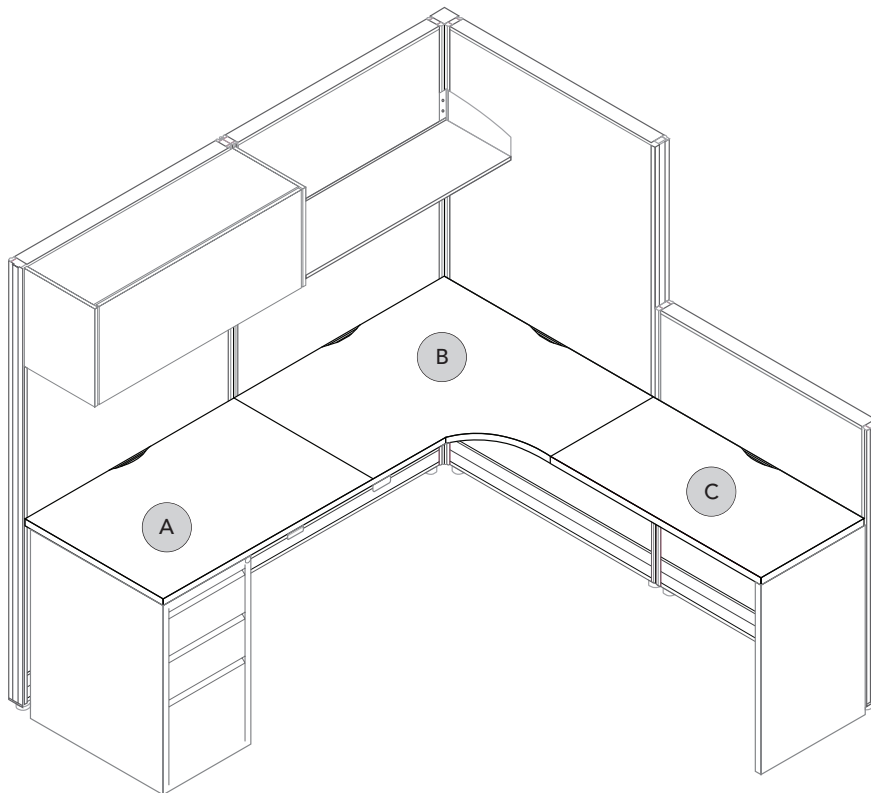

STORAGE

CS19XXBBF - WORKSURFACE SUPPORTING BOX/BOX/FILE 15" PEDESTAL

- Worksurface supporting, with predrilled holes in the top.
- Also available as freestanding with finished top.
- All drawer fronts feature a recessed, angled full pull.
- Pedestal height shown includes glide.
- Pencil tray and Lock included.
- File Bars are not included with Compile pedestals. To order file bars, use product code CSPEDHFB at \$15.00 each list.

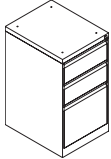
	DESCRIPTION	PRODUCT CODE	LIST PRICE	DIMENSIONS/INCHES		
				H	D	W
	Worksurface Supporting Box/Box/File 15" Pedestal	QSCS1923BBF	565	27.58	22.58	15

CS19XXFF - WORKSURFACE SUPPORTING FILE/FILE 15" PEDESTAL

- Worksurface supporting, with predrilled holes in the top.
- Also available as freestanding with finished top.
- All drawer fronts feature a recessed, angled full pull.
- Pedestal height shown includes glide.
- Lock included.
- File Bars are not included with Compile pedestals. To order file bars, use product code CSPEDHFB at \$15.00 each list.

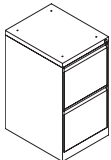
	DESCRIPTION	PRODUCT CODE	LIST PRICE	DIMENSIONS/INCHES		
				H	D	W
	Worksurface Supporting File/File 15" Pedestal	QSCS1923FF	565	27.58	22.58	15.5

CSMCPXXBFNC - MOBILE BOX/FILE PEDESTAL WITH 60MM CASTERS

- Mobile pedestal that includes one pencil tray.
- Includes factory installed counterweight.
- Lock is standard.
- 60mm high castors.
- For use with pedestal seat cushion. See model below.
- Casters do not lock.

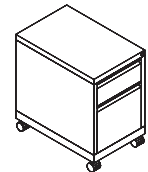
	DESCRIPTION	PRODUCT CODE	LIST PRICE	DIMENSIONS/INCHES		
				H	D	W
	Mobile Box/File Pedestal with 60mm Castors	QSCMCP23BFNC	829	23.78	22.58	15



STORAGE

CSSL13 - LOW PROFILE SHELF

- 13" deep panel-mounted storage shelf with backlip.
- Mounting brackets are included.

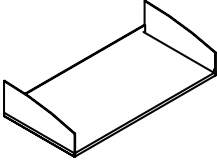
	DESCRIPTION	PRODUCT CODE	LIST PRICE	DIMENSIONS/INCHES		
				H	D	W
	Low Profile Shelf - 13"	QSCSSL1330	150	5	13	30
		QSCSSL1336	163	5	13	36
		QSCSSL1342	175	5	13	42
		QSCSSL1348	184	5	13	48

CSOF13 - KD OVERHEAD

- Mounting brackets are included.
- Door retracts up and over the cabinet.
- Ready for quick assembly on site.
- Quality steel construction.
- 60" unit is reinforced for proper weight distribution.
- Inside dimensions: 12" h x 12.75" d

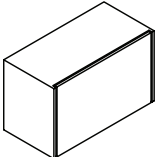
	DESCRIPTION	PRODUCT CODE	LIST PRICE	DIMENSIONS/INCHES		
				H	D	W
	KD Overhead - 13"	QSCSOF1330	392	14.5	13	30
		QSCSOF1336	432	14.5	13	36
		QSCSOF1342	457	14.5	13	42
		QSCSOF1348	483	14.5	13	48

CMSLK13 - LOCK FOR KD OVERHEAD

- Must be specified separately.

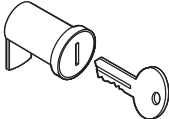
	DESCRIPTION	PRODUCT CODE	LIST PRICE	DIMENSIONS/INCHES		
				H	D	W
	Lock for KD Overhead	QSCMSLK13	44			

CSLOCKKEY - CORE AND KEY

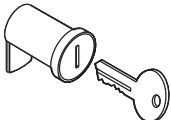
	DESCRIPTION	PRODUCT CODE	LIST PRICE	DIMENSIONS/INCHES		
				H	D	W
	LOCKKEY - Core and Key	QSCSLOCKKEY	42			

STORAGE

CS19XXP - 2F12 - LATERAL FILES - 2 DRAWERS WITH COUNTERWEIGHT

- Counterweight is standard. Two fixed front drawers.
- Side-to-side hanging file bars included.
- Drawers are 12.25" high.
- File cannot be used to store standard three ring binders.
- Lock included.

	DESCRIPTION	PRODUCT CODE	LIST PRICE	DIMENSIONS/INCHES		
				H	D	W
	Lateral Files - 2 Drawers with Counterweight	QSCS1930P-2F12	985	27.14	19.25	30
		QSCS1936P-2F12	1061	27.14	19.25	36