

worksurfaces

**The information listed below provides you with basic features of Compile Worksurfaces.**

- Compile thermally fused Worksurfaces are 1" thick and are finished with 3 mm PVC edging on all sides.
- Worksurfaces are predrilled to enable proper alignment with worksurface supports.
- Standard laminate offerings are available in thermally-fused (T). See laminate listings for details.
- Wood grain laminates on corner Worksurfaces up to 42" available in laminate run diagonally for an upcharge. Otherwise, standard horizontal application of laminate will be used.
- Most wood grain laminate Worksurfaces will have matching woodgrain trim unless specified otherwise.
- Depth of the Worksurface scoops are 1 1/8" when measured from the Panel the Worksurface is attached to.
- All Worksurfaces require support items. These are priced separately within this section.
- Grain Direction for Worksurfaces are as follows:

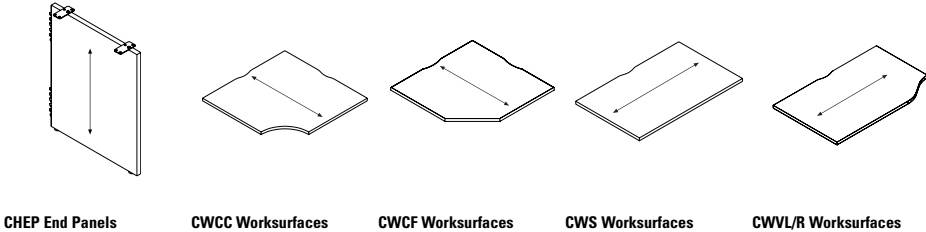

- Communication and electrical wires are routed through a cable scoop located at the back of the Worksurface. When specifying a Straight Worksurface (CWS) or a Curvilinear Worksurface (CWVL), note that the number of cable scoops depends upon the width of the Worksurface. All other Worksurface shapes have one scoop on Panel edges.

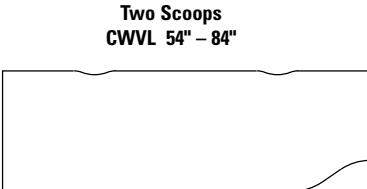
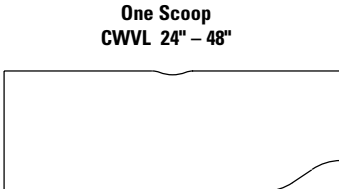
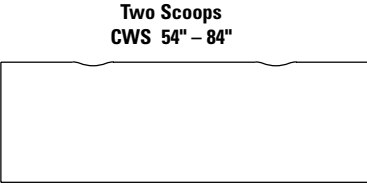
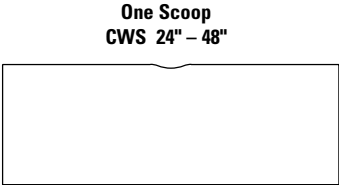

This page provides a three dimensional view of a sample configuration highlighting each **Worksurface** component required when specifying this configuration.

## Components

- A.** CWVL2436 Curvilinear Worksurface – Left  
 Note: When deepest end equals 24", opposite depth is 18"  
 When deepest end equals 30", opposite depth is 24"
- B.** CWCC3618 Corner Curved Worksurface
- C.** CWVR2436 Curvilinear Worksurface – Right

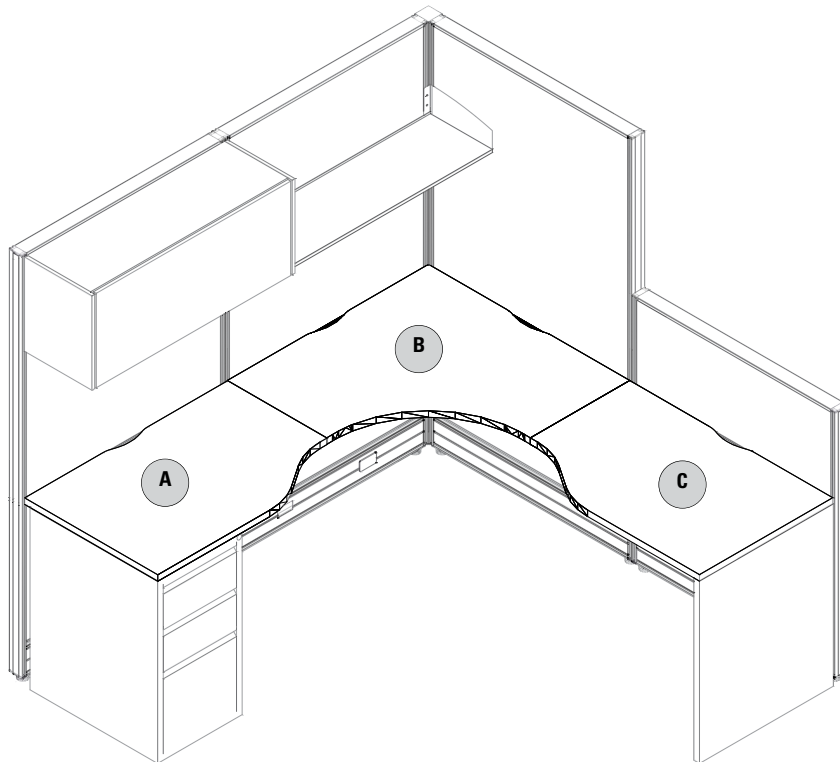

# WORKSURFACES

## CWS - RECTANGULAR WORKSURFACES

- All tops are thermally fused 1" thick with pilot holes to enable proper alignment with worksurface supports. Wood screws must be used.
- Compile worksurfaces feature a 3mm edge.
- Support hardware must be ordered separately. See the listings in this section.
- Width and depth dimensions listed include a nominal measurement (3/8") to account for wire management between the worksurface and adjoining panel.
- All surfaces over 48" will have two scoops, all others have one.
- Worksurfaces greater than 48" wide require additional structural support.

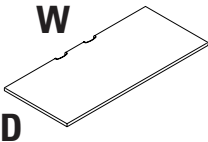
	DESCRIPTION	PRODUCT CODE	LIST PRICE	DIMENSIONS/INCHES		
				D	W	
	Rectangular Worksurfaces - 24" Deep	CWS2424P	149	24	24	
		CWS2430P	160	24	30	
		CWS2436P	179	24	36	
		CWS2442P	229	24	42	
		CWS2448P	277	24	48	
		CWS2454P	323	24	54	
		CWS2460P	363	24	60	
		CWS2466P	379	24	66	
		CWS2472P	393	24	72	
		CWS2478P	632	24	78	
		CWS2484P	639	24	84	
		CWS2490P	670	24	90	
		CWS2496P	715	24	96	
		Rectangular Worksurfaces - 30" Deep	CWS3024P	175	30	24
			CWS3030P	186	30	30
			CWS3036P	220	30	36
CWS3042P	309		30	42		
CWS3048P	323		30	48		
CWS3054P	354		30	54		
CWS3060P	379		30	60		
CWS3066P	392		30	66		
CWS3072P	416		30	72		
CWS3078P	786		30	78		
CWS3084P	801	30	84			

# WORKSURFACES

## CWSNSC - STRAIGHT WORKSURFACE NO SCOOP

- There is no scoop on this worksurface.
- Worksurface depth is exact, not nominal.
- Support hardware must be ordered separately. See listing in this section of the price book.
- For use with Bridges II or Princeton style legs.
- Surfaces not available in HPW.
- Worksurfaces greater than 48" wide require additional structural support.

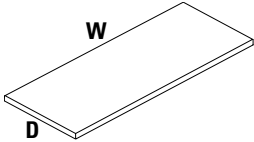
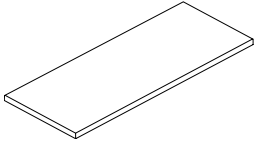
	DESCRIPTION	PRODUCT CODE	LIST PRICE	DIMENSIONS/INCHES	
				D	W
	Straight Worksurface No Scoops - 24" Deep	CWS2424NSC	149	24	24
		CWS2430NSC	160	24	30
		CWS2436NSC	179	24	36
		CWS2442NSC	229	24	42
		CWS2448NSC	277	24	48
		CWS2454NSC	323	24	54
		CWS2460NSC	363	24	60
		CWS2466NSC	379	24	66
		CWS2472NSC	393	24	72
		CWS2478NSC	632	24	78
		CWS2484NSC	639	24	84
		CWS2490NSC	752	24	90
		CWS2496NSC	715	24	96
	Straight Worksurface No Scoops - 30" Deep	CWS3024NSC	175	30	24
		CWS3030NSC	186	30	30
		CWS3036NSC	220	30	36
		CWS3042NSC	309	30	42
		CWS3048NSC	323	30	48
		CWS3054NSC	354	30	54
		CWS3060NSC	379	30	60
		CWS3066NSC	392	30	66
		CWS3072NSC	416	30	72
		CWS3078NSC	786	30	78
		CWS3084NSC	801	30	84

# WORKSURFACES

## CWSNSCP - RECTANGULAR WORKSURFACE, NO SCOOPS FOR HEIGHT ADJUSTABLE TABLES

- There is no scoop on this work surface.
- Worksurface depth is exact, not nominal.
- Support hardware must be ordered separately. See listing in this section of the price book.
- For use with Height Adjustable Tables
- Surfaces not available in HPW.

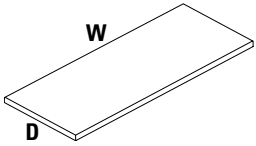
	DESCRIPTION	PRODUCT CODE	LIST PRICE	DIMENSIONS/INCHES		
				H	D	W
	Rectangular Worksurface No Scoops for Height Adjustable Tables	CWS2346NSCP	277	1	23	46
		CWS2352NSCP	323	1	23	52
		CWS2358NSCP	363	1	23	58
		CWS2364NSCP	379	1	23	64
		CWS2370NSCP	393	1	23	70
		CWS2946NSCP	323	1	29	46
		CWS2952NSCP	354	1	29	52
		CWS2958NSCP	379	1	29	58
		CWS2964NSCP	392	1	29	64
		CWS2970NSCP	416	1	29	70

# WORKSURFACES

## CWSWNSC - WEDGE WORKSURFACE NO SCOOP

- There is no scoop on this worksurface.
- Worksurface depth is exact, not nominal.
- Support hardware must be ordered separately. See listing in this section of the price book.
- For use with Bridges II or Princeton style legs.
- Surfaces not available in HPW.
- Worksurfaces greater than 48" wide require additional structural support.

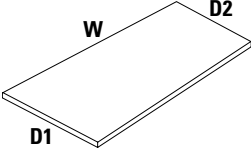
	DESCRIPTION	PRODUCT CODE	LIST PRICE	DIMENSIONS/INCHES		
				D1	D2	W
	Straight Wedge Worksurface No Scoops - Left	CWSW241848NSC	385	24	18	48
		CWSW241854NSC	434	24	18	54
		CWSW241860NSC	478	24	18	36
		CWSW241866NSC	529	24	18	42
		CWSW241872NSC	576	24	18	48
		CWSW302448NSC	478	30	24	60
	Straight Wedge Worksurface No Scoops - Right	CWSW182448NSC	385	24	18	24
		CWSW182454NSC	434	24	18	30
		CWSW182460NSC	478	24	18	36
		CWSW182466NSC	529	24	18	42
		CWSW182472NSC	576	24	18	48
		CWSW243048NSC	478	30	24	60
		CWSW243054NSC	540	30	24	66
CWSW243060NSC	600	30	24	72		
CWSW243066NSC	659	30	24	78		
CWSW243072NSC	722	30	24	84		

## CWSP - RECTANGULAR WORKSURFACES - SPAN A POST

- All tops are thermally fused 1" thick with pilot holes to enable proper alignment with worksurface supports. Wood screws must be used.
- Compile worksurfaces feature a 3mm edge.
- Support hardware must be ordered separately. See the listings in this section.
- Note: Width and depth dimensions listed include a nominal measurement (3/8") to account for wire management between the worksurface and adjoining panel.

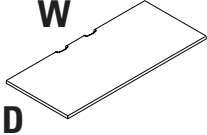
	DESCRIPTION	PRODUCT CODE	LIST PRICE	DIMENSIONS/INCHES	
				D	W
	Rectangular Worksurfaces - 24" Deep Span a Post	CWSP2426P	179	24	26
		CWSP2432P	216	24	32
		CWSP2438P	251	24	38
		CWSP2444P	283	24	44
		CWSP2450P	320	24	50
		CWSP2456P	354	24	56
		CWSP2462P	468	24	62
		CWSP2468P	510	24	68
		CWSP2474P	554	24	74
		CWSP2480P	595	24	80
	CWSP2486P	679	24	86	
	Rectangular Worksurfaces - 30" Deep Span a Post	CWSP3026P	224	30	26
		CWSP3032P	268	30	32
		CWSP3038P	317	30	38
		CWSP3044P	354	30	44
CWSP3050P		400	30	50	
CWSP3056P	443	30	56		
CWSP3062P	585	30	62		
CWSP3068P	636	30	68		
CWSP3074P	692	30	74		
CWSP3080P	742	30	80		
CWSP3086P	847	30	86		

# WORKSURFACES

## CWVR - CURVILINEAR WORKSURFACES - RIGHT

- All tops are thermally fused 1" thick with pilot holes to enable proper alignment with worksurface supports. Wood screws must be used.
- Compile worksurfaces feature a 3mm edge.
- When deepest end equals 24", the opposite depth is 18". When deepest end equals 30", the opposite depth is 24"
- Support hardware must be ordered separately. See the listings in this section.
- Note: Width and depth dimensions listed include a nominal measurement (3/8") to account for wire management between the worksurface and adjoining panel.
- Worksurfaces greater than 48" wide require additional structural support.

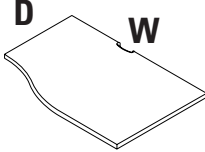
	DESCRIPTION	PRODUCT CODE	LIST PRICE	DIMENSIONS/INCHES		
				D	W	
	Curvilinear Worksurfaces - 24" Deep	CWVR2424P	192	24	24	
		CWVR2430P	198	24	30	
		CWVR2436P	239	24	36	
		CWVR2442P	277	24	42	
		CWVR2448P	316	24	48	
		CWVR2454P	354	24	54	
		CWVR2460P	384	24	60	
		CWVR2466P	424	24	66	
		CWVR2472P	456	24	72	
		CWVR2478P	632	24	78	
		CWVR2484P	639	24	84	
		Curvilinear Worksurfaces - 30" Deep	CWVR3024P	198	30	24
			CWVR3030P	210	30	30
CWVR3036P	248		30	36		
CWVR3042P	340		30	42		
CWVR3048P	354		30	48		
CWVR3054P	392		30	54		
CWVR3060P	424		30	60		
CWVR3066P	456		30	66		
CWVR3072P	485		30	72		
CWVR3078P	786		30	78		
CWVR3084P	801		30	84		

## CWVL - CURVILINEAR WORKSURFACES - LEFT

- All tops are thermally fused 1" thick with pilot holes to enable proper alignment with worksurface supports. Wood screws must be used.
- Compile worksurfaces feature a 3mm edge.
- When deepest end equals 24", the opposite depth is 18". When deepest end equals 30", the opposite depth is 24"
- Support hardware must be ordered separately. See the listings in this section.
- Note: Width and depth dimensions listed include a nominal measurement (3/8") to account for wire management between the worksurface and adjoining panel.

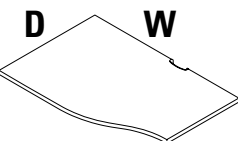
	DESCRIPTION	PRODUCT CODE	LIST PRICE	DIMENSIONS/INCHES		
				D	W	
	Curvilinear Worksurfaces - 24" Deep	CWVL2424P	192	24	24	
		CWVL2430P	198	24	30	
		CWVL2436P	239	24	36	
		CWVL2442P	277	24	42	
		CWVL2448P	316	24	48	
		CWVL2454P	354	24	54	
		CWVL2460P	384	24	60	
		CWVL2466P	424	24	66	
		CWVL2472P	456	24	72	
		CWVL2478P	632	24	78	
		CWVL2484P	639	24	84	
		Curvilinear Worksurfaces - 30" Deep	CWVL3024P	198	30	24
			CWVL3030P	210	30	30
CWVL3036P	248		30	36		
CWVL3042P	340		30	42		
CWVL3048P	354		30	48		
CWVL3054P	392		30	54		
CWVL3060P	424		30	60		
CWVL3066P	456		30	66		
CWVL3072P	485		30	72		
CWVL3078P	786		30	78		
CWVL3084P	801		30	84		

# WORKSURFACES

## CWCC - CORNER CURVED WORKSURFACES

- All tops are thermally fused 1" thick with pilot holes to enable proper alignment with worksurface supports. Wood screws must be used.
- Compile worksurfaces feature a 3mm edge.
- Support hardware must be ordered separately. See the listings in this section.
- Note: Width and depth dimensions listed include a nominal measurement (38") to account for wire management between the worksurface and adjoining panel.
- Note: Wood grain laminates do not run diagonally on corner worksurfaces.
- Worksurfaces greater than 48" wide require additional structural support.

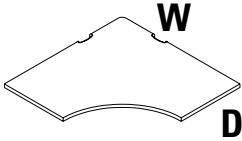
	DESCRIPTION	PRODUCT CODE	LIST PRICE	DIMENSIONS/INCHES	
				D	W
	Corner Curved Worksurfaces - 36"	CWCC3618P	499	18	36
		CWCC3624P	547	24	36
	Corner Curved Worksurfaces - 42"	CWCC4224P	738	24	42
		CWCC4230P	803	30	42
	Corner Curved Worksurfaces - 48"	CWCC4824P	863	24	48
		CWCC4830P	904	30	48

## CWCF - FIVE SIDED WORKSURFACES

- All tops are thermally fused 1" thick with pilot holes to enable proper alignment with worksurface supports. Wood screws must be used.
- Compile worksurfaces feature a 3mm edge.
- Support hardware must be ordered separately. See the listings in this section.
- Note: Width and depth dimensions listed include a nominal measurement (38") to account for wire management between the worksurface and adjoining panel.
- Note: Wood grain laminates do not run diagonally on corner worksurfaces.

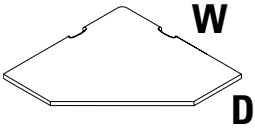
	DESCRIPTION	PRODUCT CODE	LIST PRICE	DIMENSIONS/INCHES	
				D	W
	Five Sided Worksurface - 36"	CWCF3618P	494	18	36
		CWCF3624P	547	24	36
	Five Sided Worksurface - 42"	CWCF4224P	738	24	42
		CWCF4230P	803	30	42
	Five Sided Worksurface - 48"	CWCF4824P	863	24	48
		CWCF4830P	904	30	48

# WORKSURFACES

## CWC6 - CURVED CORNER WORKSURFACE FOR 60° POST

- All tops are thermally fused 1" thick with pilot holes to enable proper alignment with worksurface supports. Wood screws must be used.
- Compile worksurfaces feature a 3mm edge.
- Support hardware must be ordered separately. See the listings in this section.
- Note: Width and depth dimensions listed include a nominal measurement (3/8") to account for wire management between the worksurface and adjoining panel.
- Note: Wood grain laminates do not run diagonally on corner worksurfaces.
- Worksurfaces greater than 48" wide require additional structural support.

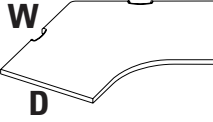
DESCRIPTION	PRODUCT CODE	LIST PRICE TF	DIMENSIONS/INCHES	
			D	W
 Curved Corner Worksurface for 60° Post - 24"	CWC62424P	466	24	24
	CWC62430P	828	24	30
	CWC62436P	929	24	36
	CWC62442P	1420	24	42
	CWC62448P	1549	24	48
Curved Corner Worksurface for 60° Post - 30"	CWC63024P	466	30	24
	CWC63030P	828	30	30
	CWC63036P	929	30	36
	CWC63042P	1420	30	42
	CWC63048P	1549	30	48

## CWC6L - EXTENDED CURVED CORNER - LEFT

- There are three cable scoops on this worksurface
- Support hardware must be ordered separately. See listing in this section of the price list
- Note: Wood Grain Laminates do not run diagonally on Extended Curved Corners

DESCRIPTION	PRODUCT CODE	LIST PRICE	DIMENSIONS/INCHES		
			D1	D2	W
 Extended Curved Corner - 36" x 24"	CWC6L362448P	675	36	24	48
	CWC6L362460P	736	36	24	60
	CWC6L362466P	807	36	24	66
	CWC6L362472P	893	36	24	72
	CWC6L362478P	954	36	24	78
	CWC6L362484P	1027	36	24	84
Extended Curved Corner - 42" x 24"	CWC6L422460P	774	42	24	60
	CWC6L422466P	848	42	24	66
	CWC6L422472P	941	42	24	72
	CWC6L422478P	1004	42	24	78
	CWC6L422484P	1083	42	24	84
Extended Curved Corner - 42" x 30"	CWC6L423060P	870	42	30	60
	CWC6L423066P	954	42	30	66
	CWC6L423072P	1044	42	30	72
	CWC6L423078P	1118	42	30	78
	CWC6L423084P	1191	42	30	84
Extended Curved Corner - 48" x 24"	CWC6L482460P	915	48	24	60
	CWC6L482466P	989	48	24	66
	CWC6L482472P	1062	48	24	72
	CWC6L482478P	1169	48	24	78
	CWC6L482484P	1215	48	24	84
Extended Curved Corner - 48" x 30"	CWC6L483060P	969	48	30	60
	CWC6L483066P	1054	48	30	66
	CWC6L483072P	1144	48	30	72
	CWC6L483078P	1231	48	30	78
	CWC6L483084P	1286	48	30	84

# WORKSURFACES

## CWCER - EXTENDED CURVED CORNER - RIGHT

- There are three cable scoops on this worksurface
- Support hardware must be ordered separately. See listing in this section of the price list
- Note: Wood Grain Laminates do not run diagonally on Extended Curved Corners
- Worksurfaces greater than 48" wide require additional structural support.

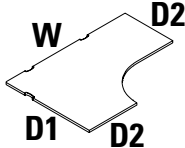
	DESCRIPTION	PRODUCT CODE	LIST PRICE	DIMENSIONS/INCHES		
				D1	D2	W
	Extended Curved Corner - 36" x 24"	CWCER362448P	675	36	24	48
		CWCER362460P	736	36	24	60
		CWCER362466P	807	36	24	66
		CWCER362472P	893	36	24	72
		CWCER362478P	954	36	24	78
		CWCER362484P	1027	36	24	84
	Extended Curved Corner - 42" x 24"	CWCER422460P	774	42	24	60
		CWCER422466P	848	42	24	66
		CWCER422472P	941	42	24	72
		CWCER422478P	1004	42	24	78
		CWCER422484P	1083	42	24	84
	Extended Curved Corner - 42" x 30"	CWCER423060P	870	42	30	60
		CWCER423066P	954	42	30	66
		CWCER423072P	1044	42	30	72
		CWCER423078P	1118	42	30	78
		CWCER423084P	1191	42	30	84
	Extended Curved Corner - 48" x 24"	CWCER482460P	915	48	24	60
		CWCER482466P	989	48	24	66
		CWCER482472P	1062	48	24	72
		CWCER482478P	1169	48	24	78
		CWCER482484P	1215	48	24	84
	Extended Curved Corner - 48" x 30"	CWCER483060P	969	48	30	60
		CWCER483066P	1054	48	30	66
		CWCER483072P	1144	48	30	72
		CWCER483078P	1231	48	30	78
		CWCER483084P	1286	48	30	84

## CWD - "D" WORKSURFACE

- Support hardware must be ordered separately. See listing in this section of the price list
- Monoleg is included

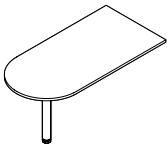
	DESCRIPTION	PRODUCT CODE	LIST PRICE	DIMENSIONS/INCHES	
				D	W
	"D" Worksurface - 24"	CWD2442P	553	24	42
		CWD2448P	568	24	48
		CWD2460P	595	24	60
		CWD2472P	636	24	72
	"D" Worksurface - 30"	CWD3042P	599	30	42
		CWD3048P	606	30	48
		CWD3060P	636	30	60
		CWD3072P	706	30	72

# WORKSURFACES

## CWH - HATCHET WORKSURFACE (LEFT SHOWN)

- Cable scoop is in the center of the 36" wide edge.
- Support hardware must be ordered separately. See listing in this section of the price list
- Monoleg is included
- Must be specified either left or right handed.
- Note: Wood Grain Laminates do not run diagonally on Hatchet Corners
- Worksurfaces greater than 48" wide require additional structural support.

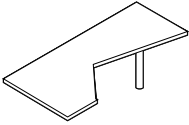
	DESCRIPTION	PRODUCT CODE	LIST PRICE	DIMENSIONS/INCHES		
				D1	D2	W
	Hatchet Worksurface - Left	CWHL3672P	1213	36	30	72
	Hatchet Worksurface - Right	CWHR3672P	1213	36	30	72

Right Shown

## CWSW - STRAIGHT WEDGE WORKSURFACES

- Support hardware must be ordered separately. See the listings in this section.
- Must be specified either left or right handed.

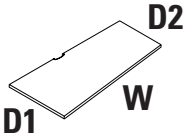
	DESCRIPTION	PRODUCT CODE	LIST PRICE	DIMENSIONS/INCHES			
				D1	D2	W	
	Straight Wedge Worksurface - Left	CWSW241848P	385	24	18	48	
		CWSW241854P	434	24	18	54	
		CWSW241860P	478	24	18	60	
		CWSW241866P	529	24	18	66	
		CWSW241872P	576	24	18	72	
			CWSW302448P	478	30	24	48
			CWSW302454P	540	30	24	54
			CWSW302460P	600	30	24	60
			CWSW302466P	659	30	24	66
			CWSW302472P	722	30	24	72
	Straight Wedge Worksurface - Right		CWSW182448P	385	18	24	48
			CWSW182454P	434	18	24	54
			CWSW182460P	478	18	24	60
			CWSW182466P	529	18	24	66
CWSW182472P			576	18	24	72	
			CWSW243048P	478	24	30	48
			CWSW243054P	540	24	30	54
			CWSW243060P	600	24	30	60
			CWSW243066P	659	24	30	66
		CWSW243072P	722	24	30	72	

## CWQR - QUARTER ROUND PANEL WORKSURFACE

- The worksurface edge running along the panel is a slightly different length than that of the worksurface end, causing the surface to be handed.
- Left hand surface shown.
- Support hardware must be ordered separately. See the listings in this section.

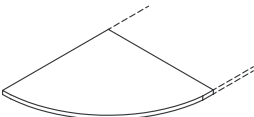
	DESCRIPTION	PRODUCT CODE	LIST PRICE	DIMENSIONS/INCHES	
				D	W
	Quarter Round Panel Worksurface - Left	CWQRL2424	229	24	24
		CWQRL3030	303	30	30
	Quarter Round Panel Worksurface - Right	CWQRR2424	229	24	24
		CWQRR3030	303	30	30

# WORKSURFACES

## CWQRC - QUARTER ROUND PANEL CORNER WORKSURFACE

- Wraps around a 90° corner post.
- Support hardware must be ordered separately. See the listing in this section.
- Worksurfaces greater than 48" wide require additional structural support.

DESCRIPTION	PRODUCT CODE	LIST PRICE	DIMENSIONS/INCHES	
			D	W
Quarter Round Panel Corner Worksurface	CWQRC2424	275	24	24
	CWQRC3030	339	30	30

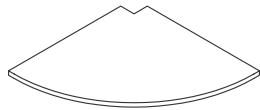

## CWT - STRAIGHT TRANSACTION WORKSURFACE

- Support hardware must be ordered separately. See the listings in this section.
- Compile worksurfaces feature a 3mm edge.

DESCRIPTION	PRODUCT CODE	LIST PRICE	DIMENSIONS/INCHES	
			D	W
Straight Transaction Worksurface	CWT1512	69	15	12
	CWT1518	91	15	18
	CWT1524	109	15	24
	CWT1530	130	15	30
	CWT1536	148	15	36
	CWT1542	165	15	42
	CWT1548	188	15	48
	CWT1554	205	15	54
	CWT1560	227	15	60
	CWT1566	243	15	66
	CWT1572	265	15	72
	CWT1578	283	15	78
	CWT1584	302	15	84

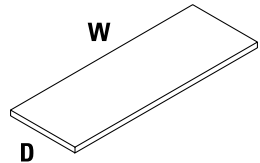

## CWTE - END TRANSACTION SURFACE

- Support hardware must be ordered separately. See the listings in this section.
- Extends 1.5" past end of run.
- Compile worksurfaces feature a 3mm edge.

DESCRIPTION	PRODUCT CODE	LIST PRICE	DIMENSIONS/INCHES	
			D	W
End Transaction Surface	CWTE1512	91	15	14
	CWTE1518	109	15	20
	CWTE1524	130	15	26
	CWTE1530	148	15	32
	CWTE1536	165	15	38
	CWTE1542	188	15	44
	CWTE1548	205	15	50
	CWTE1554	227	15	56
	CWTE1560	243	15	62
	CWTE1566	265	15	68
	CWTE1572	283	15	74

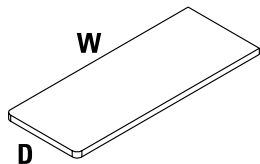

# WORKSURFACES

## CWTCL - "L" CORNER TRANSACTION SURFACE

- Support hardware must be ordered separately. See the listings in this section.
- When specifying this item along with a straight surface, deduct 12" from each return side.
- Worksurfaces greater than 48" wide require additional structural support.

DESCRIPTION	PRODUCT CODE	LIST PRICE	DIMENSIONS/INCHES	
			D	W
"L" Corner Transaction Surface	CWTCL90	193	15	21

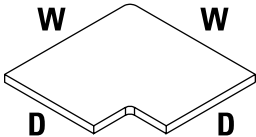

## CW9T - CORNER TRANSACTION SURFACE FOR 90° POST

- Support hardware must be ordered separately. See the listing in this section.

DESCRIPTION	PRODUCT CODE	LIST PRICE	DIMENSIONS/INCHES	
			D	W
Corner Transaction Surface for 90° Post	CW9T1524	263	15	32.861
	CW9T1530	313	15	38.861
	CW9T1536	362	15	44.861
	CW9T1542	410	15	50.861
	CW9T1548	465	15	56.861

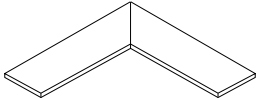

## CHCB2 - CORNER BRACKET

- Attaches the corner of any worksurface to a panel connector.
- Priced and shipped in pairs.
- Available in standard paint colors.
- Cannot be used off modular.
- Can be used when a panel is the same depth as the worksurface in the front and back application.

DESCRIPTION	PRODUCT CODE	LIST PRICE	DIMENSIONS/INCHES	
			D	W
Corner Bracket	CHCB2	24	2.5	

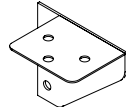

## CHWB1 - MID SPAN SUPPORT BRACKET

- Does not need to be on module.
- Used when a panel exceeds the depth of the adjacent worksurface.
- Can only be used with a Segmented Panel.
- Comes in unfinished zinc.

DESCRIPTION	PRODUCT CODE	LIST PRICE	DIMENSIONS/INCHES	
			D	W
Mid Span Support Bracket	CHWB1	15		

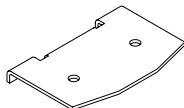

# WORKSURFACES

## CHC15 & CHC22- CANTILEVER

- Attaches a worksurface to a panel.
- Use one cantilever to support two convergent worksurfaces when specified with 3 Flat Brackets or two cantilevers with one flat bracket to support two convergent worksurfaces.
- Does not include Flat Brackets.
- Priced individually
- Specify handedness of each cantilever
- Available in standard paint colors.
- Right and left Cantilever needs to be specified unless flat brackets are also specified.

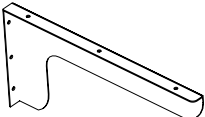
	DESCRIPTION	PRODUCT CODE	LIST PRICE	DIMENSIONS/INCHES	
				D	W
	Cantilever - 15"	CHC15L	54	15	6
		CHC15R	54	15	6
	Cantilever - 22"	CHC22L	83	22	6
		CHC22R	83	22	6

## CMHC - WORKSURFACE SUPPORT CHANNEL

- Support channel attaches to underside of worksurface with screws
- Support channel should be 14" shorter than top length.
- Screws are included.
- Only available in Black.
- Tops with post legs should be specified with support channel for structural reinforcement.

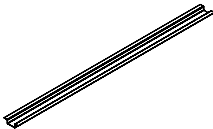
	DESCRIPTION	PRODUCT CODE	LIST PRICE	DIMENSIONS/INCHES	
				L	D
	Worksurface Support Channel	CMHC40 - for 54" wide table	90	40	5
		CMHC46 - for 60" wide table	98	46	5
		CMHC52 - for 66" wide table	109	52	5
		CMHC58 - for 72" wide table	122	58	5
		CMHC64 - for 78" wide table	133	64	5
		CMHC70 - for 84" wide table	148	70	5

## CHFB1 - FLAT BRACKET

- Use in conjunction with Cantilever to make it a shared Cantilever to support convergent worksurfaces.
- Used at the front of 2 convergent worksurfaces to keep worksurfaces flush at seams.
- Available in Black only.

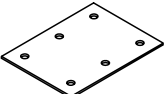
	DESCRIPTION	PRODUCT CODE	LIST PRICE	DIMENSIONS/INCHES	
				D	W
	Flat Bracket	CHFB1	23	3	4

## CHTB2 - TRANSACTION TOP BRACKETS

- Securely attaches a transaction surface to the top of a panel.
- One pair must be on each side of transaction surface.
- Priced and shipped in pairs.
- Available in Anodized Aluminum only.

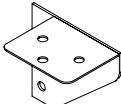
	DESCRIPTION	PRODUCT CODE	LIST PRICE	DIMENSIONS/INCHES	
				D	W
	Flat Bracket	CHTB2	24	2.5	

# WORKSURFACES

## CHEP - END PANEL

- Supports the worksurface and enhances the stability of connected panels.
- Provides solid support at the end of a run of worksurfaces.
- Finished in thermally-fused laminate.
- Includes flat brackets and hardware.
- End panel height is inclusive of panel glides extended to their fullest height.
- If wood grains is selected, grain runs vertically.

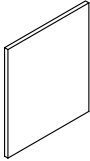
	DESCRIPTION	PRODUCT CODE	LIST PRICE	DIMENSIONS/INCHES	
				D	W
	End Panel - 28"High	CHEP2924	283	28	24
		CHEP2930	333	28	30

## CHMSL - MID SUPPORT LEG

- Provides support for a worksurface.
- Includes leveling glide, PVC Sleeve and 4.8" x 4.8" attachment plate.
- 1.5" diameter.
- Available in standard paint colors.

	DESCRIPTION	PRODUCT CODE	LIST PRICE	DIMENSIONS/INCHES
				H
	Mid Support Leg - Round	CHMSL1	98	28
	Mid Support Leg - Square	CHMSL2	98	28

## CMHCL & CHHCL - CORNER LEG WITH LEVELER

- Provides support for a worksurface.
- Includes leveling glide, PVC Sleeve and attachment plate.
- 1.5" diameter
- Available in standard paint colors.
- Legs can be used in the corner of a single worksurface or be rotated 45 degrees to support the corners of two worksurfaces.

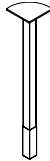
	DESCRIPTION	PRODUCT CODE	LIST PRICE	DIMENSIONS/INCHES
				H
 	Corner Leg Round	CMHCL1	136	28
	Corner Leg Square	CMHCL2	136	28

## CHWS - 5" SURFACE TO STORAGE SUPPORT LEG

- Provides support for a worksurface.
- Includes leveling glide, PVC Sleeve and 4.8" x 4.8" attachment plate.
- 1.5" diameter.
- Available in standard paint colors.

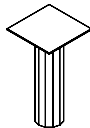
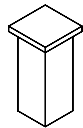
	DESCRIPTION	PRODUCT CODE	LIST PRICE	DIMENSIONS/INCHES
				H
 	5" Surface to Storage Support Leg - Round	CHWSRL01	64	4.5
	5" Surface to Storage Support Leg - Square	CHWSSL01	64	4.5

Round      Square

# WORKSURFACES

## CHMEGR - METAL END GABLE ROUND LEG, NON-HANDED

- Supports the worksurface and enhances the stability of connected panels.
- Includes a levelling glide and decorative PVC sleeve to cover the glide.
- Attaches to Compile panel connectors. The mounting bracket is universal and attaches with screws to the back of the leg.
- Available in standard paint colors.
- NOTE: Cannot be used to support worksurfaces side by side. Please use EVHMSRL12 for supporting adjoining worksurfaces.

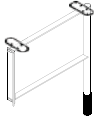
	DESCRIPTION	PRODUCT CODE	LIST PRICE	DIMENSIONS/INCHES		
				H	D	W
	Metal End Gable Round Leg	CHMEGR24	329	29	2	23
	Non-handed	CHMEGR30	345	29	2	29

## CHMSRL - METAL MID SUPPORT ROUND LEG

- Supports two adjoining worksurface and enhances the stability of connected panels.
- Includes a levelling glide and decorative PVC sleeve to cover the glide.
- Attaches to Compile panels.
- Available in standard paint colors.

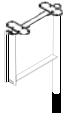
	DESCRIPTION	PRODUCT CODE	LIST PRICE	DIMENSIONS/INCHES		
				H	D	W
	Metal Mid Support Round Leg	CHMSRL12	279	29	2	11

## CHMEGS - METAL END GABLE SQUARE LEG, NON-HANDED

- Supports the worksurface and enhances the stability of connected panels.
- Includes a levelling glide and decorative PVC sleeve to cover the glide.
- Attaches to Compile panel connectors. The mounting bracket is universal and attaches with screws to the back of the leg.
- Available in standard paint colors.
- NOTE: Cannot be used to support worksurfaces side by side. Please use EVHMSRL12 for supporting adjoining worksurfaces.

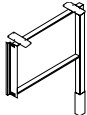
	DESCRIPTION	PRODUCT CODE	LIST PRICE	DIMENSIONS/INCHES		
				H	D	W
	Metal End Gable Square Leg	CHMEGS24	317	29	2	23
	Non-handed	CHMEGS30	352	29	2	29

## CHMSSL - METAL MID SUPPORT SQUARE LEG

- Supports two adjoining worksurface and enhances the stability of connected panels.
- Includes a levelling glide and decorative PVC sleeve to cover the glide.
- Attaches to Compile panels.
- Available in standard paint colors.

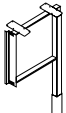
	DESCRIPTION	PRODUCT CODE	LIST PRICE	DIMENSIONS/INCHES		
				H	D	W
	Metal End Gable Square Leg	CHMSSL12	286	29	2	11

# WORKSURFACES

## PEDESTAL FILLER BRACKET

- Screws to back of pedestal
- Fills the gap between the pedestal and panel when wing pnael is not used.

DESCRIPTION	PRODUCT CODE	LIST PRICE	DIMENSIONS/INCHES		
			D	W	

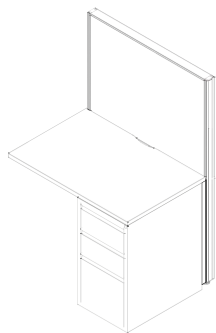

Pedestal Filler Bracket-	CHPBF	65	26.875	1.375	
--------------------------	-------	----	--------	-------	--

## CHPEDB - FLUSH PEDESTAL BRACKET

- Attaches metal or laminate storage or desking, to Compile panels for additional panel support
- Used in flush mount applications only
- Use CHPBF Pedestal Filler Bracket with CS19xx Pedestals and standard depth worksurfaces

DESCRIPTION	PRODUCT CODE	LIST PRICE	DIMENSIONS/INCHES		
			H	W	D



Flush Pedestal Bracket	CHPEDB	32	8	1	1
------------------------	--------	----	---	---	---