

panels

**THE INFORMATION LISTED BELOW PROVIDES YOU WITH BASIC FEATURES OF COMPILE PANELS:**

- Compile Panels are:
  - Available in five (5) heights: 30", 42", 48", 54" and 66"; and seven (7) widths: 24", 30", 36", 42", 48", 54" and 60".
  - 2 3/8" thick.
  - Monolithic, Segmented, Acoustic, and Glazed.
- Acoustic panels are lightly tackable with 0.70 NRC rating and a 26 STC rating.
- Compile Non - Acoustic panels are not tackable.
- Raceway openings are 1.375" x 2.680".
- Panels 24" wide include raceway covers with 2 knockouts.
- Panels 30" – 60" wide include raceway covers with 3 knockouts.
- Opposite sides of each Module may have a different fabric within the same grade at no upcharge.
- If different grades of fabric are used on one panel, the entire panel must be priced at the highest grade.
- Standard with aluminum frame.
- Individual fabric covered acoustic modules incorporated into an aluminum frame.
- Reinforced aluminum raceway covers are included when ordering panel packages or may be ordered and shipped separately. Raceway covers can be replaced in the field to change a panel from non-powered to powered (or vice versa).
- Base raceway lifts up and locks in an upright 90-degree position, or can be removed for open access to base raceway.
- Electric knockouts in the raceway have black plastic covers that snap into place from the outside of the cover, when a duplex is not required. Electric knockout covers must be specified separately. Available in standard paint finishes.
- 3 panel connector brackets per side for 30"h, 42"h and 54"h come installed on panels and universal posts.
- 4 panel connector brackets per side for 66"h panels come installed on panels and universal posts.
- Panel connector brackets are opposite direction of each other per panel side, and can be removed with one screw per bracket.

MONOLITHIC PANEL PACKAGES - PAGES 16 & 17, 22-25

Non-Powered Compile Monolithic Fabric Panel Package

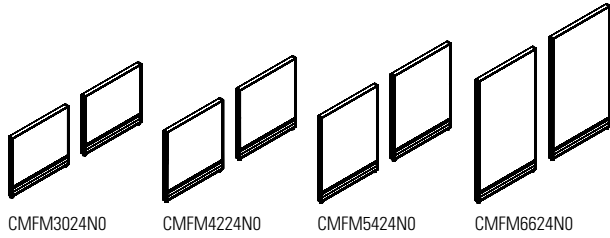

Powered Compile Monolithic Fabric Panel Package

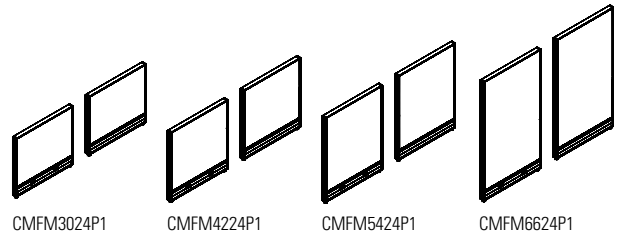

Non-Powered Compile Monolithic Fabric Panel Package

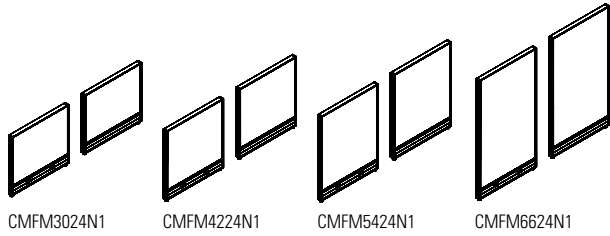

Powered Compile Monolithic Fabric Panel Package

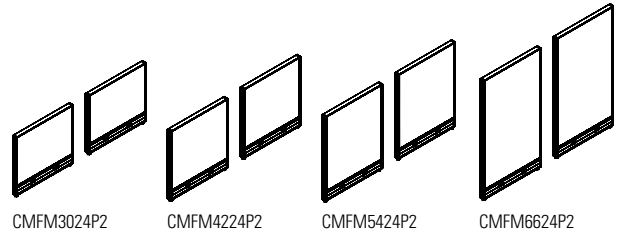

Non-Powered Compile Monolithic Fabric Panel Package

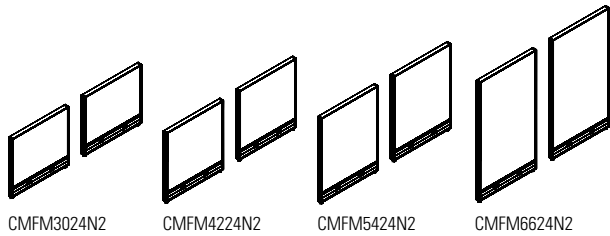

Non-Powered Compile Monolithic Laminate Panel Package

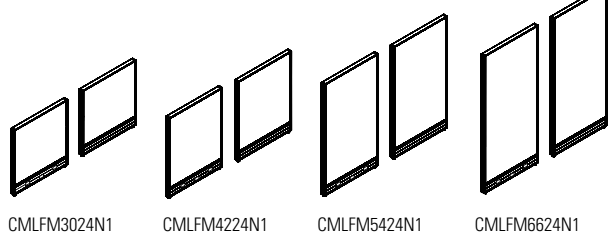

Non-Powered Compile Monolithic Laminate Panel Package

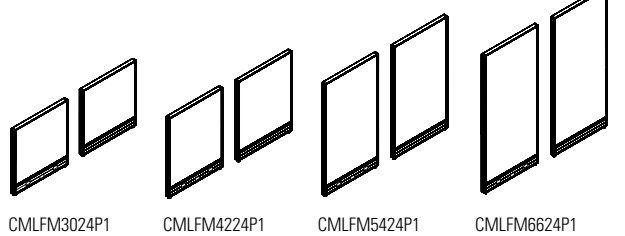

Model Definitions:

- N0 = No punch outs on raceways.
- N1 = Raceway punch out on one side.
- N2 = Raceway punch out on both sides.
- P1 = Power harness and raceway punch out on one side.
- P2 = Power harness and raceway punch outs on two sides.

RACEWAY COVER OPTIONS (Suffix)

- (N0) No Knockouts Side 1 and Side 2
- (N1) Knockouts Side 1 – No Knockout Side 2
- (N2) Knockouts Side 1 and Side
- (P1) Knockouts Side 1 – No Knockout Side 2
- (P2) Knockouts Side 1 and Side 2

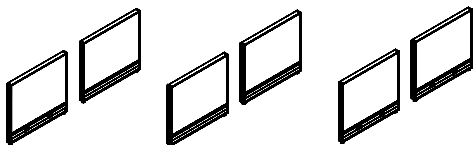

SEGMENTED - PANEL PACKAGES - PAGES 18 & 19, 26-35

Non-Powered Compile Single Segmented Fabric Panel Package

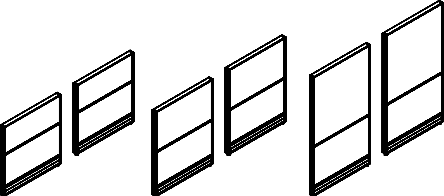

CMFF4224N0 CMFF5424N0 CMFF6624N0

Powered Compile Single Segmented Fabric Panel Package

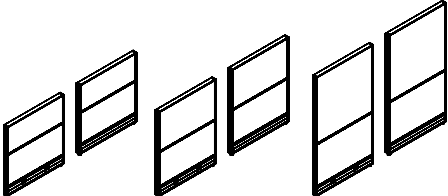

CMFF4224P1 CMFF5424P1 CMFF6624P1

Non-Powered Compile Single Segmented Fabric Panel Package

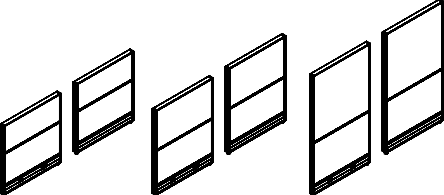

CMFF4224N1 CMFF5424N1 CMFF6624N1

Powered Compile Single Segmented Fabric Panel Package

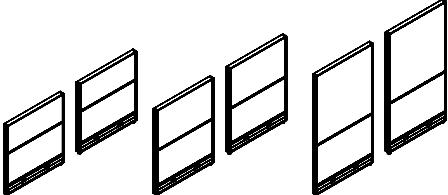

CMFF4224P2 CMFF5424P2 CMFF6624P2

Non-Powered Compile Single Segmented Fabric Panel Package

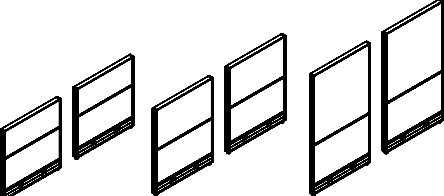

CMFF4224N2 CMFF5424N2 CMFF6624N2

ACOUSTIC PANEL PACKAGES - PAGES 20 & 21

Non-Powered Compile Monolithic Acoustic Panel Package

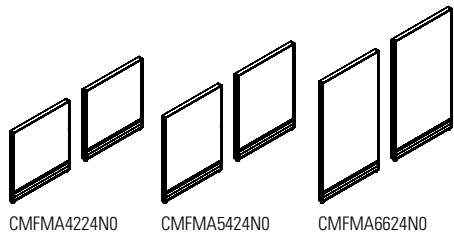

CMFMA4224N0 CMFMA5424N0 CMFMA6624N0

Powered Compile Monolithic Acoustic Panel Package

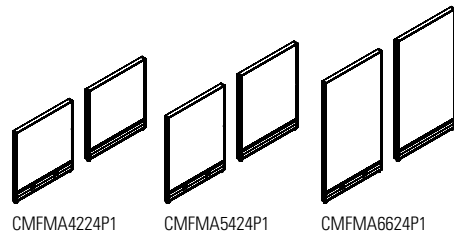

CMFMA4224P1 CMFMA5424P1 CMFMA6624P1

Non-Powered Compile Monolithic Acoustic Panel Package

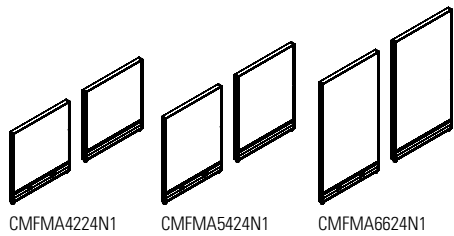

CMFMA4224N1 CMFMA5424N1 CMFMA6624N1

Powered Compile Monolithic Acoustic Panel Package

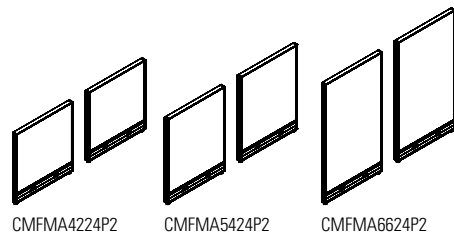

CMFMA4224P2 CMFMA5424P2 CMFMA6624P2

Non-Powered Compile Monolithic Acoustic Panel Package

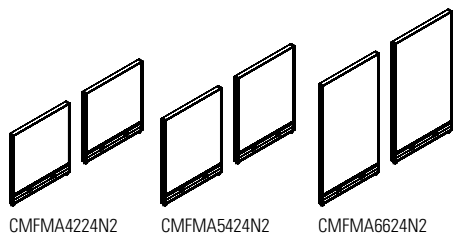

CMFMA4224N2 CMFMA5424N2 CMFMA6624N2

SINGLE SEGMENTED OPEN BOTTOM PANEL PACKAGES - PAGES 34-35

Non-Powered Compile Single Segmented Open Bottom Panel Package

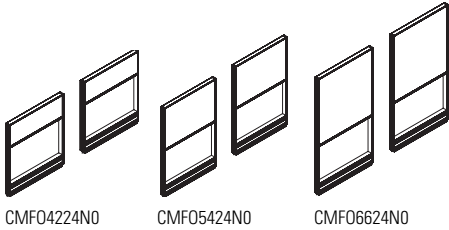

Powered Compile Single Segmented Open Bottom Panel Package

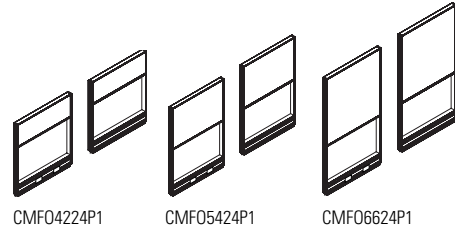

Non-Powered Compile Single Segmented Open Bottom Panel Package

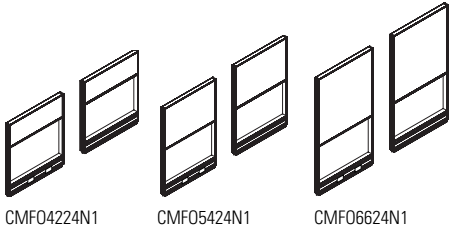

Powered Compile Single Segmented Open Bottom Panel Package

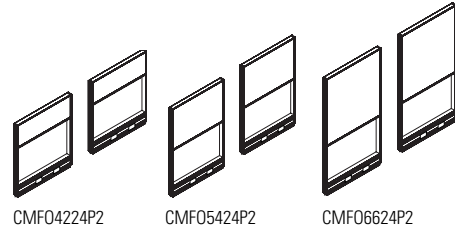

Non-Powered Compile Single Segmented Open Bottom Panel Package

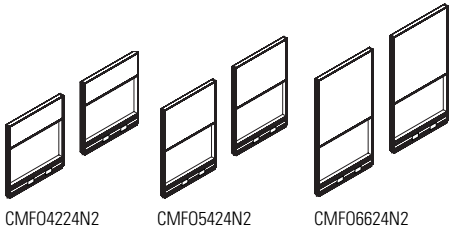

DOOR PANELS - PAGE 55

Sliding Door

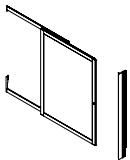

CMPDPS6636/42

GLAZED PANEL PACKAGES - PAGES 36-37

Non-Powered Compile Glazed Panel Package

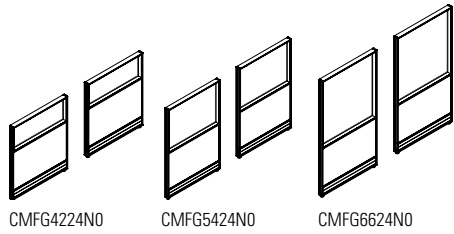

Powered Compile Glazed Panel Package

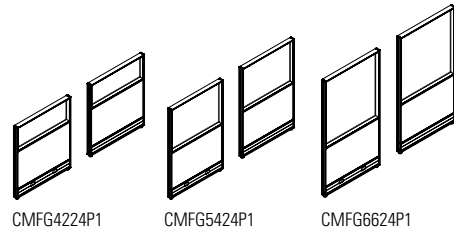

Non-Powered Compile Glazed Panel Package

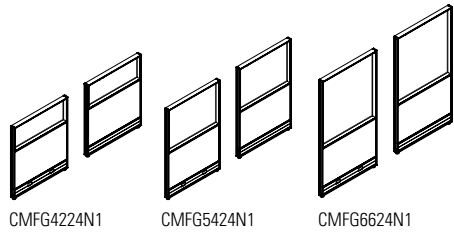

Powered Compile Glazed Panel Package

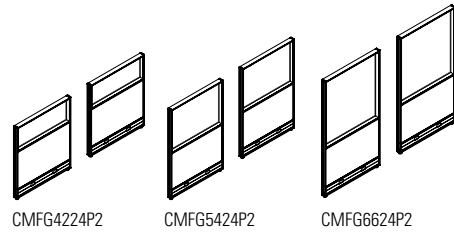

Non-Powered Compile Glazed Panel Package

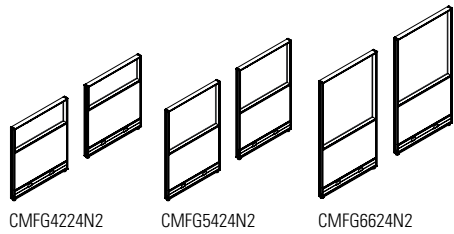

PARTLY GLAZED PANEL PACKAGES - PAGES 38-41

Non-Powered Compile Partly Glazed Panel Package

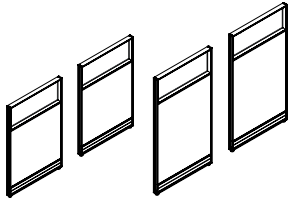

CMPG5424N0

CMPG6624N0

Powered Compile Partly Glazed Panel Package

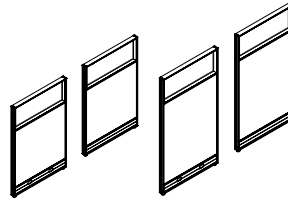

CMPG5424P1

CMPG6624P1

Non-Powered Compile Partly Glazed Panel Package

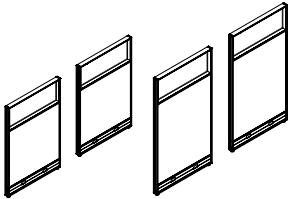

CMPG5424N1

CMPG6624N1

Powered Compile Partly Glazed Panel Package

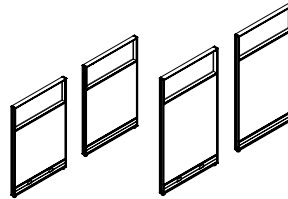

CMPG5424P2

CMPG6624P2

Non-Powered Compile Partly Glazed Panel Package

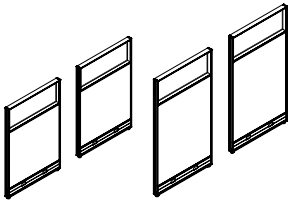

CMPG5424N2

CMPG6624N2

Compile Privacy Glass

Available in widths from 24" to 60".

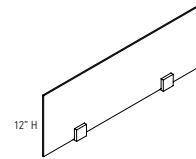

CMPS30

MINI PANEL KIT - PAGE 43

Mini Panel Kit

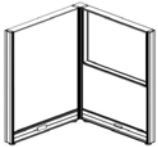

CMFMA2418KIT1

This page provides an exploded view of a sample Panel Package highlighting each **Panel** component included within the package.

## Package Components

### Package 1 CMFM6636N0

- A. (1) 66" h x 36" w Monolithic Fabric Panel
- B. (2) 36" w Raceway Covers Without Knockouts

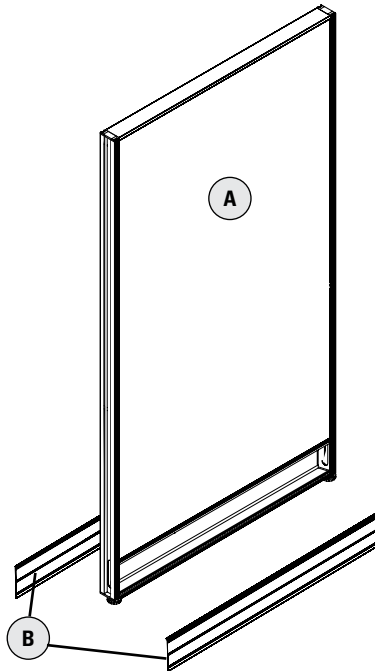

### Package 2 CMFF6636P2

- C. (1) 66" h x 36" w Single Segmented Fabric Panel
- D. (2) 36" w Raceway Covers With Knockouts
- E. (1) 36" w Power Distribution Housing

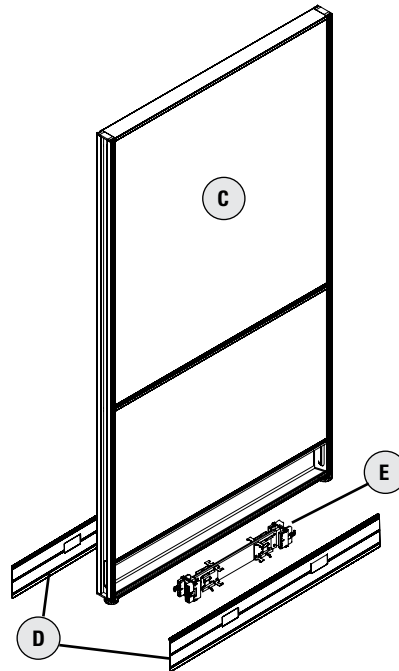

### Package 3 CHP66-2

- F. (1) 66" h Universal Corner Post
- G. (2) Trim Inserts for 66" Universal Corner Post
- H. (1) Post Base Cover for 2-Way Application
- I. "Quick Connect" comes standard with Panels and Universal Corner Post

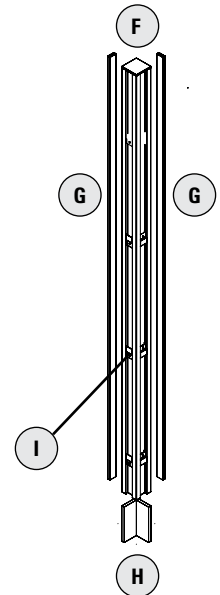

**CMFMXXYYN - NON-POWERED COMPILE FABRIC MONOLITHIC PANEL PACKAGE**

- Non powered.
- Includes one panel and two raceway covers with no punchouts.
- Individual fabric-covered modules incorporated into an aluminum frame.
- Opposite sides of each module may have a different fabric within the same grade at no upcharge.
- If different grades of fabric are used on one panel, the entire panel must be priced at highest grade.
- Panels are not tackable or acoustical.
- Note: Trim is not required at a straight connection between two panels of the same height.
- 3 Panel connector brackets per side come standard with 30”h, 42”h, 48”h and 54”h panels.
- 4 Panel connector brackets per side come standard with 66”h panels.
- Panels contain leveling glides. Maximum extension of glides is 2”.

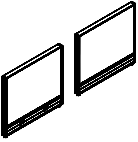
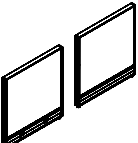
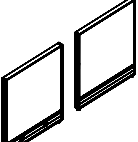
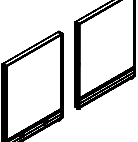
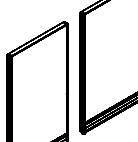
	DESCRIPTION	PRODUCT CODE	LIST PRICE		DIMENSIONS/INCHES		
			Gr1	Gr2	H	W	D
	Non-Powered Compile Fabric Monolithic Panel Package - 30"	CMFM3024N_	391	427	30	24	2 3/8
		CMFM3030N_	441	476	30	30	2 3/8
		CMFM3036N_	479	548	30	36	2 3/8
		CMFM3042N_	529	598	30	42	2 3/8
		CMFM3048N_	562	631	30	48	2 3/8
		CMFM3054N_	622	691	30	54	2 3/8
		CMFM3060N_	656	724	30	60	2 3/8
	Non-Powered Compile Fabric Monolithic Panel Package - 42"	CMFM4224N_	391	427	42	24	2 3/8
		CMFM4230N_	441	476	42	30	2 3/8
		CMFM4236N_	479	548	42	36	2 3/8
		CMFM4242N_	529	598	42	42	2 3/8
		CMFM4248N_	562	631	42	48	2 3/8
		CMFM4254N_	622	691	42	54	2 3/8
		CMFM4260N_	656	724	42	60	2 3/8
	Non-Powered Compile Fabric Monolithic Panel Package - 48"	CMFM4824N_	407	448	48	24	2 3/8
		CMFM4830N_	462	503	48	30	2 3/8
		CMFM4836N_	513	593	48	36	2 3/8
		CMFM4842N_	571	652	48	42	2 3/8
		CMFM4848N_	600	682	48	48	2 3/8
		CMFM4854N_	650	732	48	54	2 3/8
		CMFM4860N_	710	789	48	60	2 3/8
	Non-Powered Compile Fabric Monolithic Panel Package - 54"	CMFM5424N_	408	450	54	24	2 3/8
		CMFM5430N_	462	504	54	30	2 3/8
		CMFM5436N_	514	596	54	36	2 3/8
		CMFM5442N_	571	653	54	42	2 3/8
		CMFM5448N_	601	684	54	48	2 3/8
		CMFM5454N_	651	734	54	54	2 3/8
		CMFM5460N_	710	792	54	60	2 3/8
	Non-Powered Compile Fabric Monolithic Panel Package - 66"	CMFM6624N_	456	511	66	24	2 3/8
		CMFM6630N_	524	579	66	30	2 3/8
		CMFM6636N_	598	698	66	36	2 3/8
		CMFM6642N_	671	771	66	42	2 3/8
		CMFM6648N_	726	826	66	48	2 3/8
		CMFM6654N_	808	908	66	54	2 3/8
		CMFM6660N_	888	990	66	60	2 3/8

**Raceway Cover Options (1) Shown**

- **RACEWAY COVER OPTIONS (Suffix)**
  - (0) No Knockouts Side 1 and Side 2
  - (1) Knockouts Side 1 – No Knockout Side 2
  - (2) Knockouts Side 1 and Side 2

**CMFMXXYP - POWERED COMPILE FABRIC MONOLITHIC PANEL PACKAGE**

- With power distribution harness.
- Includes one panel, power harness, one raceway cover with punchout and one raceway cover with no punchout.
- Individual fabric-covered modules incorporated into an aluminum frame.
- Opposite sides of each module may have a different fabric within the same grade at no upcharge.
- If different grades of fabric are used on one panel, the entire panel must be priced at highest grade.
- Panels are not tackable or acoustical.
- Note: Trim is not required at a straight connection between two panels of the same height.
- 3 Panel connector brackets per side come standard with 30”h, 42”h, 48”h and 54”h panels.
- 4 Panel connector brackets per side come standard with 66”h panels.
- Panels contain leveling glides. Maximum extension of glides is 2”.

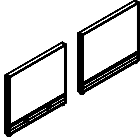
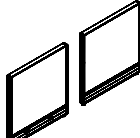
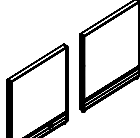
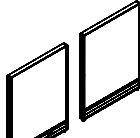
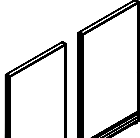
	DESCRIPTION	PRODUCT CODE	LIST PRICE		DIMENSIONS/INCHES		
			Gr1	Gr2	H	W	D
	Powered Compile Fabric Monolithic Panel Package - 30"	CMFM3024P_	556	592	30	24	2 3/8
		CMFM3030P_	663	698	30	30	2 3/8
		CMFM3036P_	712	781	30	36	2 3/8
		CMFM3042P_	766	835	30	42	2 3/8
		CMFM3048P_	818	887	30	48	2 3/8
		CMFM3054P_	878	947	30	54	2 3/8
		CMFM3060P_	914	982	30	60	2 3/8
	Powered Compile Fabric Monolithic Panel Package - 42"	CMFM4224P_	556	592	42	24	2 3/8
		CMFM4230P_	663	698	42	30	2 3/8
		CMFM4236P_	712	781	42	36	2 3/8
		CMFM4242P_	766	835	42	42	2 3/8
		CMFM4248P_	818	887	42	48	2 3/8
		CMFM4254P_	878	947	42	54	2 3/8
		CMFM4260P_	914	982	42	60	2 3/8
	Powered Compile Fabric Monolithic Panel Package - 48"	CMFM4824P_	571	613	48	24	2 3/8
		CMFM4830P_	680	721	48	30	2 3/8
		CMFM4836P_	742	823	48	36	2 3/8
		CMFM4842P_	806	887	48	42	2 3/8
		CMFM4848P_	858	939	48	48	2 3/8
		CMFM4854P_	904	986	48	54	2 3/8
		CMFM4860P_	966	1047	48	60	2 3/8
	Powered Compile Fabric Monolithic Panel Package - 54"	CMFM5424P_	571	613	54	24	2 3/8
		CMFM5430P_	680	722	54	30	2 3/8
		CMFM5436P_	745	827	54	36	2 3/8
		CMFM5442P_	807	889	54	42	2 3/8
		CMFM5448P_	858	941	54	48	2 3/8
		CMFM5454P_	905	988	54	54	2 3/8
		CMFM5460P_	966	1048	54	60	2 3/8
	Powered Compile Fabric Monolithic Panel Package - 66"	CMFM6624P_	619	674	66	24	2 3/8
		CMFM6630P_	745	800	66	30	2 3/8
		CMFM6636P_	830	930	66	36	2 3/8
		CMFM6642P_	907	1007	66	42	2 3/8
		CMFM6648P_	983	1083	66	48	2 3/8
		CMFM6654P_	1065	1165	66	54	2 3/8
		CMFM6660P_	1144	1246	66	60	2 3/8

**Raceway Cover Options (1) Shown**

- **RACEWAY COVER OPTIONS (Suffix)**
  - (1) Knockouts Side 1 – No Knockout Side 2
  - (2) Knockouts Side 1 and Side 2

**CMFFXXYYN - NON-POWERED COMPILE SINGLE SEGMENTED FABRIC PANEL PACKAGE**

- Non powered.
- Includes one panel, two raceway covers with no punchouts.
- Individual fabric-covered modules incorporated into an aluminum frame.
- Opposite sides of each module may have a different fabric within the same grade at no upcharge.
- If different grades of fabric are used on one panel, the entire panel must be priced at highest grade.
- Panels are not tackable or acoustical.
- Note: Trim is not required at a straight connection between two panels of the same height.
- 3 Panel connector brackets per side come standard with 42”h, 48”h and 54”h panels.
- 4 Panel connector brackets per side come standard with 66”h panels.
- Panels contain leveling glides. Maximum extension of glides is 2”.

	DESCRIPTION	PRODUCT CODE	LIST PRICE		DIMENSIONS/INCHES		
			Gr1	Gr2	H	W	D
	Non-Power Compile Single Segmented Fabric Panel Package - 42"	CMFF4224N_	409	445	42	24	2 3/8
		CMFF4230N_	462	498	42	30	2 3/8
		CMFF4236N_	488	556	42	36	2 3/8
		CMFF4242N_	557	626	42	42	2 3/8
		CMFF4248N_	594	663	42	48	2 3/8
		CMFF4254N_	660	729	42	54	2 3/8
		CMFF4260N_	706	775	42	60	2 3/8
		CMFF4266N_	832	965	42	66	2 3/8
		CMFF4272N_	877	1010	42	72	2 3/8
			Non-Powered Compile Single Segmented Fabric Panel Package - 48"	CMFF4824N_	446	487	48
CMFF4830N_	494			535	48	30	2 3/8
CMFF4836N_	558			639	48	36	2 3/8
CMFF4842N_	632			713	48	42	2 3/8
CMFF4848N_	682			763	48	48	2 3/8
CMFF4854N_	726			806	48	54	2 3/8
CMFF4860N_	781			862	48	60	2 3/8
	Non-Powered Compile Single Segmented Fabric Panel Package - 54"	CMFF5424N_	447	488	54	24	2 3/8
		CMFF5430N_	495	537	54	30	2 3/8
		CMFF5436N_	559	641	54	36	2 3/8
		CMFF5442N_	632	714	54	42	2 3/8
		CMFF5448N_	683	765	54	48	2 3/8
		CMFF5454N_	726	808	54	54	2 3/8
		CMFF5460N_	781	863	54	60	2 3/8
	Non-Powered Compile Single Segmented Fabric Panel Package - 66"	CMFF6624N_	523	578	66	24	2 3/8
		CMFF6630N_	596	651	66	30	2 3/8
		CMFF6636N_	663	763	66	36	2 3/8
		CMFF6642N_	756	856	66	42	2 3/8
		CMFF6648N_	801	901	66	48	2 3/8
		CMFF6654N_	868	968	66	54	2 3/8
		CMFF6660N_	922	1022	66	60	2 3/8

**Raceway Cover Options (1) Shown**

- **RACEWAY COVER OPTIONS (Suffix)**
  - (0) No Knockouts Side 1 and Side 2
  - (1) Knockouts Side 1 – No Knockout Side 2
  - (2) Knockouts Side 1 and Side 2

**CMFFXXYP\_ - POWERED COMPILE SINGLE SEGMENTED FABRIC PANEL PACKAGE**

- With power distribution harness.
- Includes one panel, power harness, one raceway cover with punchout and one raceway cover with no punchout.
- Individual fabric-covered modules incorporated into an aluminum frame.
- Opposite sides of each module may have a different fabric within the same grade at no upcharge.
- If different grades of fabric are used on one panel, the entire panel must be priced at highest grade.
- Panels are not tackable or acoustical.
- Note: Trim is not required at a straight connection between two panels of the same height.
- 3 Panel connector brackets per side come standard with 42”h, 48”h and 54”h panels.
- 4 Panel connector brackets per side come standard with 66”h panels.
- Panels contain leveling glides. Maximum extension of glides is 2”.

	DESCRIPTION	PRODUCT CODE	LIST PRICE		DIMENSIONS/INCHES		
			Gr1	Gr2	H	W	D
	Powered Compile Single Segmented Fabric Panel Package - 42”	CMFF4224P_	572	608	42	24	2 3/8
		CMFF4230P_	680	716	42	30	2 3/8
		CMFF4236P_	721	789	42	36	2 3/8
		CMFF4242P_	794	863	42	42	2 3/8
		CMFF4248P_	847	916	42	48	2 3/8
		CMFF4254P_	917	986	42	54	2 3/8
		CMFF4260P_	962	1031	42	60	2 3/8
		CMFF4266P_	1111	1243	42	66	2 3/8
		CMFF4272P_	1171	1303	42	72	2 3/8
	Powered Compile Single Segmented Fabric Panel Package - 48”	CMFF4824P_	610	650	48	24	2 3/8
		CMFF4830P_	715	756	48	30	2 3/8
		CMFF4836P_	791	870	48	36	2 3/8
		CMFF4842P_	868	949	48	42	2 3/8
		CMFF4848P_	939	1020	48	48	2 3/8
		CMFF4854P_	984	1064	48	54	2 3/8
		CMFF4860P_	1039	1118	48	60	2 3/8
	Powered Compile Single Segmented Fabric Panel Package - 54”	CMFF5424P_	611	652	54	24	2 3/8
		CMFF5430P_	715	757	54	30	2 3/8
		CMFF5436P_	793	875	54	36	2 3/8
		CMFF5442P_	869	951	54	42	2 3/8
		CMFF5448P_	940	1022	54	48	2 3/8
		CMFF5454P_	985	1067	54	54	2 3/8
		CMFF5460P_	1041	1123	54	60	2 3/8
	Powered Compile Single Segmented Fabric Panel Package - 66”	CMFF6624P_	685	740	66	24	2 3/8
		CMFF6630P_	817	872	66	30	2 3/8
		CMFF6636P_	893	993	66	36	2 3/8
		CMFF6642P_	992	1092	66	42	2 3/8
		CMFF6648P_	1054	1154	66	48	2 3/8
		CMFF6654P_	1123	1223	66	54	2 3/8
		CMFF6660P_	1177	1277	66	60	2 3/8

**Raceway Cover Options (1) Shown**

- **RACEWAY COVER OPTIONS (Suffix)**
  - (1) Knockouts Side 1 – No Knockout Side 2
  - (2) Knockouts Side 1 and Side 2

**CMFMAXYYN\_ - NON-POWERED COMPILE MONOLITHIC ACOUSTIC PANEL PACKAGE**

- Non powered.
- Includes one panel and two raceway covers with no punchouts.
- Individual fabric-covered acoustic modules incorporated into an aluminum frame.
- Opposite sides of each module may have a different fabric within the same grade at no upcharge.
- If different grades of fabric are used on one panel, the entire panel must be priced at highest grade.
- Panels are lightly tackable.
- Note: Trim is not required at a straight connection between two panels of the same height.
- 3 Panel connector brackets per side come standard with 42”h, 48”h and 54”h panels.
- 4 Panel connector brackets per side come standard with 66”h panels.
- Panels contain leveling glides. Maximum extension of glides is 2”.

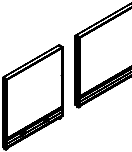
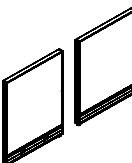
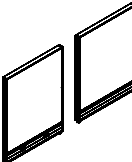
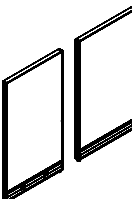
	DESCRIPTION	PRODUCT CODE	LIST PRICE		DIMENSIONS/INCHES		
			Gr1	Gr2	H	W	D
	Non-Powered Compile Monolithic Acoustic Panel Package - 42"	CMFMA4224N_	465	500	42	24	2 3/8
		CMFMA4230N_	523	558	42	30	2 3/8
		CMFMA4236N_	569	638	42	36	2 3/8
		CMFMA4242N_	624	693	42	42	2 3/8
		CMFMA4248N_	664	733	42	48	2 3/8
		CMFMA4254N_	735	804	42	54	2 3/8
		CMFMA4260N_	773	841	42	60	2 3/8
	Non-Powered Compile Monolithic Acoustic Panel Package - 48"	CMFMA4824N_	485	526	48	24	2 3/8
		CMFMA4830N_	546	570	48	30	2 3/8
		CMFMA4836N_	603	684	48	36	2 3/8
		CMFMA4842N_	675	756	48	42	2 3/8
		CMFMA4848N_	712	793	48	48	2 3/8
		CMFMA4854N_	763	844	48	54	2 3/8
		CMFMA4860N_	834	916	48	60	2 3/8
	Non-Powered Compile Monolithic Acoustic Panel Package - 54"	CMFMA5424N_	485	527	54	24	2 3/8
		CMFMA5430N_	547	589	54	30	2 3/8
		CMFMA5436N_	603	686	54	36	2 3/8
		CMFMA5442N_	675	758	54	42	2 3/8
		CMFMA5448N_	712	794	54	48	2 3/8
		CMFMA5454N_	764	847	54	54	2 3/8
		CMFMA5460N_	834	917	54	60	2 3/8
	Non-Powered Compile Monolithic Acoustic Panel Package - 66"	CMFMA6624N_	541	596	66	24	2 3/8
		CMFMA6630N_	621	676	66	30	2 3/8
		CMFMA6636N_	710	810	66	36	2 3/8
		CMFMA6642N_	798	898	66	42	2 3/8
		CMFMA6648N_	862	962	66	48	2 3/8
		CMFMA6654N_	956	1058	66	54	2 3/8
		CMFMA6660N_	1050	1150	66	60	2 3/8

**Raceway Cover Options (1) Shown**

- **RACEWAY COVER OPTIONS (Suffix)**
  - (0) No Knockouts Side 1 and Side 2
  - (1) Knockouts Side 1 – No Knockout Side 2
  - (2) Knockouts Side 1 and Side 2

**CMFMAXYYYP - POWERED COMPILE MONOLITHIC ACOUSTIC PANEL PACKAGE**

- With power distribution harness.
- Includes one panel, power harness, one raceway cover with punchout and one raceway cover with no punchout.
- Individual fabric-covered acoustic modules incorporated into an aluminum frame.
- Opposite sides of each module may have a different fabric within the same grade at no upcharge.
- If different grades of fabric are used on one panel, the entire panel must be priced at highest grade.
- Panels are lightly tackable.
- Note: Trim is not required at a straight connection between two panels of the same height.
- 3 Panel connector brackets per side come standard with 42”h, 48”h and 54”h panels.
- 4 Panel connector brackets per side come standard with 66”h panels.
- Panels contain leveling glides. Maximum extension of glides is 2”.

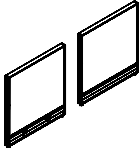
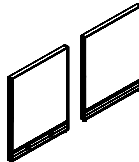
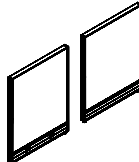
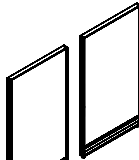
	DESCRIPTION	PRODUCT CODE	LIST PRICE		DIMENSIONS/INCHES		
			Gr1	Gr2	H	W	D
	Powered Compile Monolithic Acoustic Panel Package - 42”	CMFMA4224P_	629	664	42	24	2 3/8
		CMFMA4230P_	742	777	42	30	2 3/8
		CMFMA4236P_	801	870	42	36	2 3/8
		CMFMA4242P_	863	932	42	42	2 3/8
		CMFMA4248P_	919	988	42	48	2 3/8
		CMFMA4254P_	989	1058	42	54	2 3/8
		CMFMA4260P_	1029	1097	42	60	2 3/8
	Powered Compile Monolithic Acoustic Panel Package - 48”	CMFMA4824P_	647	688	48	24	2 3/8
		CMFMA4830P_	764	805	48	30	2 3/8
		CMFMA4836P_	835	917	48	36	2 3/8
		CMFMA4842P_	910	992	48	42	2 3/8
		CMFMA4848P_	966	1047	48	48	2 3/8
		CMFMA4854P_	1021	1103	48	54	2 3/8
		CMFMA4860P_	1091	1173	48	60	2 3/8
	Powered Compile Monolithic Acoustic Panel Package - 54”	CMFMA5424P_	650	692	54	24	2 3/8
		CMFMA5430P_	766	808	54	30	2 3/8
		CMFMA5436P_	835	918	54	36	2 3/8
		CMFMA5442P_	911	994	54	42	2 3/8
		CMFMA5448P_	966	1048	54	48	2 3/8
		CMFMA5454P_	1021	1104	54	54	2 3/8
		CMFMA5460P_	1092	1175	54	60	2 3/8
	Powered Compile Monolithic Acoustic Panel Package - 66”	CMFMA6624P_	706	761	66	24	2 3/8
		CMFMA6630P_	843	898	66	30	2 3/8
		CMFMA6636P_	941	1041	66	36	2 3/8
		CMFMA6642P_	1031	1131	66	42	2 3/8
		CMFMA6648P_	1115	1215	66	48	2 3/8
		CMFMA6654P_	1212	1314	66	54	2 3/8
		CMFMA6660P_	1305	1405	66	60	2 3/8

**Raceway Cover Options (1) Shown**

- **RACEWAY COVER OPTIONS (Suffix)**
  - (1) Knockouts Side 1 – No Knockout Side 2
  - (2) Knockouts Side 1 and Side 2

**CMLFMXXYYN - MONOLITHIC LAMINATE SINGLE SIDED PANEL – NON-POWERED**

- Individual modules, one in fabric and one in laminate, incorporated into an aluminum frame.
- Modules have laminate on one side and fabric on the other.
- Opposite sides of each module may have a different laminate within the same grade at no upcharge.
- Panels are not tackable.
- 3 panel connector brackets per side come standard with 30”h, 42”h, 48”h and 54”h panels.
- 4 panel connector brackets per side come standard with 66”h panels.
- 24” wide panels have two punchouts, one for electrical and one for data.
- 30” wide panels and wider have three punchouts, two for electrical and one for data.
- Note: Trim is not required at a straight connection between two panels of the same height.

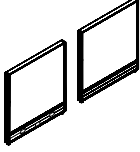
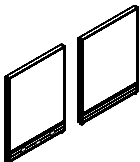
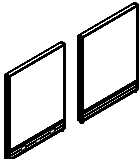
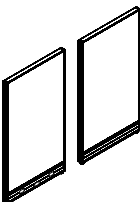
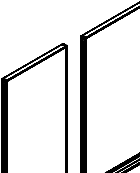
	DESCRIPTION	PRODUCT CODE	LIST PRICE		DIMENSIONS/INCHES		
			Gr1	Gr2	H	W	D
	Non-Powered Compile Monolithic Single Sided Panel Package - 30”	CMLFM3024N_	475	495	30	24	2 3/8
		CMLFM3030N_	550	564	30	30	2 3/8
		CMLFM3036N_	628	646	30	36	2 3/8
		CMLFM3042N_	712	726	30	42	2 3/8
		CMLFM3048N_	775	793	30	48	2 3/8
		CMLFM3054N_	855	876	30	54	2 3/8
		CMLFM3060N_	939	962	30	60	2 3/8
	Non-Powered Compile Monolithic Single Sided Panel Package - 42”	CMLFM4224N_	560	578	42	24	2 3/8
		CMLFM4230N_	656	677	42	30	2 3/8
		CMLFM4236N_	749	774	42	36	2 3/8
		CMLFM4242N_	850	875	42	42	2 3/8
		CMLFM4248N_	926	953	42	48	2 3/8
		CMLFM4254N_	1024	1057	42	54	2 3/8
		CMLFM4260N_	1124	1158	42	60	2 3/8
	Non-Powered Compile Monolithic Single Sided Panel Package - 48”	CMLFM4824N_	663	691	48	24	2 3/8
		CMLFM4830N_	777	798	48	30	2 3/8
		CMLFM4836N_	892	918	48	36	2 3/8
		CMLFM4842N_	1011	1043	48	42	2 3/8
		CMLFM4848N_	1103	1137	48	48	2 3/8
		CMLFM4854N_	1227	1264	48	54	2 3/8
		CMLFM4860N_	1347	1387	48	60	2 3/8
	Non-Powered Compile Monolithic Single Sided Panel Package - 54”	CMLFM5424N_	664	688	54	24	2 3/8
		CMLFM5430N_	777	804	54	30	2 3/8
		CMLFM5436N_	892	918	54	36	2 3/8
		CMLFM5442N_	1012	1045	54	42	2 3/8
		CMLFM5448N_	1103	1139	54	48	2 3/8
		CMLFM5454N_	1227	1264	54	54	2 3/8
		CMLFM5460N_	1347	1388	54	60	2 3/8
	Non-Powered Compile Monolithic Single Sided Panel Package - 66”	CMLFM6624N_	819	846	66	24	2 3/8
		CMLFM6630N_	959	992	66	30	2 3/8
		CMLFM6636N_	1106	1141	66	36	2 3/8
		CMLFM6642N_	1258	1295	66	42	2 3/8
		CMLFM6648N_	1368	1412	66	48	2 3/8
		CMLFM6654N_	1522	1571	66	54	2 3/8
		CMLFM6660N_	1675	1728	66	60	2 3/8

**Raceway Cover Options (1) Shown**

- **RACEWAY COVER OPTIONS (Suffix)**
  - (0) No Knockouts Side 1 and Side 2
  - (1) Knockouts Side 1 – No Knockout Side 2
  - (2) Knockouts Side 1 and Side 2

**CMLFMXXYP - MONOLITHIC LAMINATE SINGLE SIDED PANEL – POWERED**

- Individual modules, one in fabric and one in laminate, incorporated into an aluminum frame.
- Modules have laminate on one side and fabric on the other.
- Opposite sides of each module may have a different laminate within the same grade at no upcharge.
- Panels are not tackable.
- 3 panel connector brackets per side come standard with 30”h, 42”h, 48”h and 54”h panels.
- 4 panel connector brackets per side come standard with 66”h panels.
- 24” wide panels have two punchouts, one for electrical and one for data.
- 30” wide panels and wider have three punchouts, two for electrical and one for data.
- Note: Trim is not required at a straight connection between two panels of the same height.

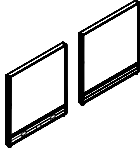
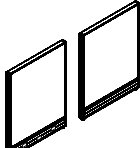
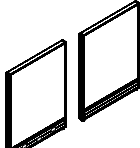
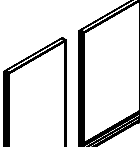
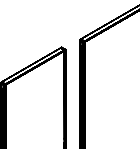
	DESCRIPTION	PRODUCT CODE	LIST PRICE		DIMENSIONS/INCHES		
			Gr1	Gr2	H	W	D
	Non-Powered Compile Monolithic Single Sided Panel Package - 30”	CMLFM3024P_	638	657	30	24	2 3/8
		CMLFM3030P_	770	846	30	30	2 3/8
		CMLFM3036P_	859	947	30	36	2 3/8
		CMLFM3042P_	949	1044	30	42	2 3/8
		CMLFM3048P_	1029	1133	30	48	2 3/8
		CMLFM3054P_	1111	1230	30	54	2 3/8
		CMLFM3060P_	1196	1325	30	60	2 3/8
	Non-Powered Compile Monolithic Single Sided Panel Package - 42”	CMLFM4224P_	724	805	42	24	2 3/8
		CMLFM4230P_	877	971	42	30	2 3/8
		CMLFM4236P_	983	1092	42	36	2 3/8
		CMLFM4242P_	1089	1210	42	42	2 3/8
		CMLFM4248P_	1182	1314	42	48	2 3/8
		CMLFM4254P_	1281	1431	42	54	2 3/8
		CMLFM4260P_	1384	1546	42	60	2 3/8
	Non-Powered Compile Monolithic Single Sided Panel Package - 48”	CMLFM4824P_	828	845	48	24	2 3/8
		CMLFM4830P_	998	1022	48	30	2 3/8
		CMLFM4836P_	1123	1151	48	36	2 3/8
		CMLFM4842P_	1246	1278	48	42	2 3/8
		CMLFM4848P_	1357	1387	48	48	2 3/8
		CMLFM4854P_	1481	1521	48	54	2 3/8
		CMLFM4860P_	1604	1799	48	60	2 3/8
	Non-Powered Compile Monolithic Single Sided Panel Package - 54”	CMLFM5424P_	829	926	54	24	2 3/8
		CMLFM5430P_	998	1114	54	30	2 3/8
		CMLFM5436P_	1123	1252	54	36	2 3/8
		CMLFM5442P_	1246	1395	54	42	2 3/8
		CMLFM5448P_	1357	1518	54	48	2 3/8
		CMLFM5454P_	1482	1659	54	54	2 3/8
		CMLFM5460P_	1604	1800	54	60	2 3/8
	Non-Powered Compile Monolithic Single Sided Panel Package - 66”	CMLFM6624P_	985	1106	66	24	2 3/8
		CMLFM6630P_	1177	1319	66	30	2 3/8
		CMLFM6636P_	1338	1500	66	36	2 3/8
		CMLFM6642P_	1492	1675	66	42	2 3/8
		CMLFM6648P_	1623	1824	66	48	2 3/8
		CMLFM6654P_	1780	2002	66	54	2 3/8
		CMLFM6660P_	1934	2175	66	60	2 3/8

**Raceway Cover Options (1) Shown**

- **RACEWAY COVER OPTIONS (Suffix)**
  - (0) No Knockouts Side 1 and Side 2
  - (1) Knockouts Side 1 – No Knockout Side 2
  - (2) Knockouts Side 1 and Side 2

**CMLLMXXYYN - MONOLITHIC LAMINATE DOUBLE SIDED PANEL - NON-POWERED**

- Individual laminate modules incorporated into an aluminum frame.
- Modules have laminate on both sides.
- Opposite sides of each module may have a different laminate within the same grade at no upcharge.
- 3 panel connector brackets per side come standard with 30”h, 42”h, 48”h and 54”h panels.
- 4 panel connector brackets per side come standard with 66”h panels.
- 24” wide panels have two punchouts, one for electrical and one for data.
- 30” wide panels and wider have three punchouts, two for electrical and one for data.
- Note: Trim is not required at a straight connection between two panels of the same height.

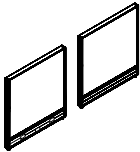
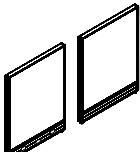
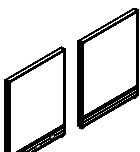
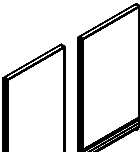
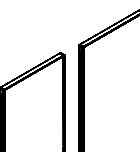
	DESCRIPTION	PRODUCT CODE	LIST PRICE Gr1	DIMENSIONS/INCHES		
				H	W	D
	Non-Powered Compile Monolithic	CMLLM3024N_	537	30	24	2 3/8
	Double Sided Laminate Panel Package - 30"	CMLLM3030N_	636	30	30	2 3/8
		CMLLM3036N_	726	30	36	2 3/8
		CMLLM3042N_	829	30	42	2 3/8
		CMLLM3048N_	925	30	48	2 3/8
		CMLLM3054N_	1023	30	54	2 3/8
		CMLLM3060N_	1106	30	60	2 3/8
	Non-Powered Compile Monolithic	CMLLM4224N_	636	42	24	2 3/8
	Double Sided Laminate Panel Package - 42"	CMLLM4230N_	748	42	30	2 3/8
		CMLLM4236N_	871	42	36	2 3/8
		CMLLM4242N_	993	42	42	2 3/8
		CMLLM4248N_	1112	42	48	2 3/8
		CMLLM4254N_	1222	42	54	2 3/8
		CMLLM4260N_	1329	42	60	2 3/8
	Non-Powered Compile Monolithic	CMLLM4824N_	752	48	24	2 3/8
	Double Sided Laminate Panel Package - 48"	CMLLM4830N_	891	48	30	2 3/8
		CMLLM4836N_	1033	48	36	2 3/8
		CMLLM4842N_	1181	48	42	2 3/8
		CMLLM4848N_	1327	48	48	2 3/8
		CMLLM4854N_	1462	48	54	2 3/8
		CMLLM4860N_	1546	48	60	2 3/8
	Non-Powered Compile Monolithic	CMLLM5424N_	752	54	24	2 3/8
	Double Sided Laminate Panel Package - 54"	CMLLM5430N_	891	54	30	2 3/8
		CMLLM5436N_	1034	54	36	2 3/8
		CMLLM5442N_	1182	54	42	2 3/8
		CMLLM5448N_	1328	54	48	2 3/8
		CMLLM5454N_	1462	54	54	2 3/8
		CMLLM5460N_	1592	54	60	2 3/8
	Non-Powered Compile Monolithic	CMLLM6624N_	952	66	24	2 3/8
	Double Sided Laminate Panel Package - 66"	CMLLM6630N_	1124	66	30	2 3/8
		CMLLM6636N_	1304	66	36	2 3/8
		CMLLM6642N_	1493	66	42	2 3/8
		CMLLM6648N_	1675	66	48	2 3/8
		CMLLM6654N_	1847	66	54	2 3/8
		CMLLM6660N_	2020	66	60	2 3/8

**Raceway Cover Options (1) Shown**

- **RACEWAY COVER OPTIONS (Suffix)**
  - (0) No Knockouts Side 1 and Side 2
  - (1) Knockouts Side 1 – No Knockout Side 2
  - (2) Knockouts Side 1 and Side 2

**CMLLMXXYP\_ - MONOLITHIC LAMINATE DOUBLE SIDED PANEL – POWERED**

- Individual laminate modules incorporated into an aluminum frame.
- Modules have laminate on both sides.
- Opposite sides of each module may have a different laminate within the same grade at no upcharge.
- 3 panel connector brackets per side come standard with 30”h, 42”h, 48”h and 54”h panels.
- 4 panel connector brackets per side come standard with 66”h panels.
- 24” wide panels have two punchouts, one for electrical and one for data.
- 30” wide panels and wider have three punchouts, two for electrical and one for data.
- Note: Trim is not required at a straight connection between two panels of the same height.

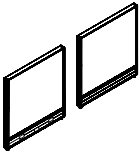
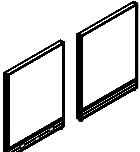
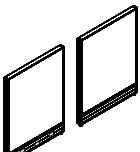
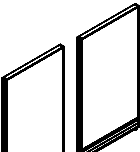
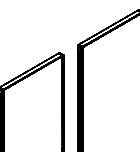
	DESCRIPTION	PRODUCT CODE	LIST PRICE Gr1	DIMENSIONS/INCHES		
				H	W	D
	Powered Compile Monolithic	CMLLM3024P_	703	30	24	2 3/8
	Double Sided Laminate Panel Package - 30”	CMLLM3030P_	858	30	30	2 3/8
		CMLLM3036P_	959	30	36	2 3/8
		CMLLM3042P_	1064	30	42	2 3/8
		CMLLM3048P_	1177	30	48	2 3/8
		CMLLM3054P_	1280	30	54	2 3/8
		CMLLM3060P_	1364	30	60	2 3/8
	Powered Compile Monolithic	CMLLM4224P_	801	42	24	2 3/8
	Double Sided Laminate Panel Package - 42”	CMLLM4230P_	970	42	30	2 3/8
		CMLLM4236P_	1105	42	36	2 3/8
		CMLLM4242P_	1231	42	42	2 3/8
		CMLLM4248P_	1366	42	48	2 3/8
		CMLLM4254P_	1480	42	54	2 3/8
		CMLLM4260P_	1587	42	60	2 3/8
	Powered Compile Monolithic	CMLLM4824P_	915	48	24	2 3/8
	Double Sided Laminate Panel Package - 48”	CMLLM4830P_	1111	48	30	2 3/8
		CMLLM4836P_	1266	48	36	2 3/8
		CMLLM4842P_	1418	48	42	2 3/8
		CMLLM4848P_	1583	48	48	2 3/8
		CMLLM4854P_	1719	48	54	2 3/8
		CMLLM4860P_	1796	48	60	2 3/8
	Powered Compile Monolithic	CMLLM5424P_	915	54	24	2 3/8
	Double Sided Laminate Panel Package - 54”	CMLLM5430P_	1112	54	30	2 3/8
		CMLLM5436P_	1266	54	36	2 3/8
		CMLLM5442P_	1418	54	42	2 3/8
		CMLLM5448P_	1584	54	48	2 3/8
		CMLLM5454P_	1721	54	54	2 3/8
		CMLLM5460P_	1848	54	60	2 3/8
	Powered Compile Monolithic	CMLLM6624P_	1115	66	24	2 3/8
	Double Sided Laminate Panel Package - 66”	CMLLM6630P_	1347	66	30	2 3/8
		CMLLM6636P_	1536	66	36	2 3/8
		CMLLM6642P_	1731	66	42	2 3/8
		CMLLM6648P_	1929	66	48	2 3/8
		CMLLM6654P_	2104	66	54	2 3/8
		CMLLM6660P_	2277	66	60	2 3/8

**Raceway Cover Options (1) Shown**

- **RACEWAY COVER OPTIONS (Suffix)**
  - (0) No Knockouts Side 1 and Side 2
  - (1) Knockouts Side 1 – No Knockout Side 2
  - (2) Knockouts Side 1 and Side 2

## CMFLXXYYN - SEGMENTED LAMINATE SINGLE SIDED PANEL – NON-POWERED

- Individual fabric or laminate covered modules incorporated into an aluminum frame.
- Modules have laminate on one side and fabric on the other.
- Opposite sides of each module may have a different laminate within the same grade at no upcharge.
- If different grades of fabric are used on one panel, the entire panel must be priced at highest grade.
- Panels are not tackable.
- Note: Trim is not required at a straight connection between two panels of the same height.
- 3 Panel connector brackets per side come standard with 42”h, 48h” and 54”h panels.
- 4 Panel connector brackets per side come standard with 66”h panels.
- 24” wide panels have two punchouts, one for electrical and one for data.
- 30” wide panels and wider have three punchouts, two for electrical and one for data.

	DESCRIPTION	PRODUCT CODE	LIST PRICE		DIMENSIONS/INCHES		
			Gr1	Gr2	H	W	D
	Non-Powered Compile Single Segmented Laminate Panel Package - 42"	CMFL4224N_	560	579	42	24	2.38
		CMFL4230N_	656	677	42	30	2.38
		CMFL4236N_	749	775	42	36	2.38
		CMFL4242N_	850	876	42	42	2.38
		CMFL4248N_	926	954	42	48	2.38
		CMFL4254N_	1024	1057	42	54	2.38
		CMFL4260N_	1124	1158	42	60	2.38
	Non-Powered Compile Single Segmented Laminate Panel Package - 48"	CMFL4824N_	663	684	48	24	2.38
		CMFL4830N_	777	798	48	30	2.38
		CMFL4836N_	892	919	48	36	2.38
		CMFL4842N_	1011	1044	48	42	2.38
		CMFL4848N_	1103	1136	48	48	2.38
		CMFL4854N_	1227	1468	48	54	2.38
		CMFL4860N_	1347	1389	48	60	2.38
	Non-Powered Compile Single Segmented Laminate Panel Package - 54"	CMFL5424N_	664	688	54	24	2.38
		CMFL5430N_	777	804	54	30	2.38
		CMFL5436N_	892	919	54	36	2.38
		CMFL5442N_	1012	1045	54	42	2.38
		CMFL5448N_	1103	1139	54	48	2.38
		CMFL5454N_	1227	1265	54	54	2.38
		CMFL5460N_	1347	1389	54	60	2.38
	Non-Powered Compile Single Segmented Laminate Panel Package - 66"	CMFL6624N_	819	847	66	24	2.38
		CMFL6630N_	959	992	66	30	2.38
		CMFL6636N_	1106	1141	66	36	2.38
		CMFL6642N_	1258	1293	66	42	2.38
		CMFL6648N_	1368	1413	66	48	2.38
		CMFL6654N_	1522	1572	66	54	2.38
		CMFL6660N_	1675	1729	66	60	2.38

### Raceway Cover Options (1) Shown

- **RACEWAY COVER OPTIONS (Suffix)**
  - (0) No Knockouts Side 1 and Side 2
  - (1) Knockouts Side 1 – No Knockout Side 2
  - (2) Knockouts Side 1 and Side 2

**CMFLXXYP\_ - SEGMENTED LAMINATE SINGLE SIDED PANEL – POWERED**

- Individual fabric or laminate covered modules incorporated into an aluminum frame.
- Modules have laminate on one side and fabric on the other.
- Opposite sides of each module may have a different laminate within the same grade at no upcharge.
- If different grades of fabric are used on one panel, the entire panel must be priced at highest grade.
- Panels are not tackable.
- Note: Trim is not required at a straight connection between two panels of the same height.
- 3 Panel connector brackets per side come standard with 42”h, 48h” and 54”h panels.
- 4 Panel connector brackets per side come standard with 66”h panels.
- 24” wide panels have two punchouts, one for electrical and one for data.
- 30” wide panels and wider have three punchouts, two for electrical and one for data.

	DESCRIPTION	PRODUCT CODE	LIST PRICE		DIMENSIONS/INCHES		
			Gr1	Gr2	H	W	D
	Powered Compile Single Segmented Laminate Panel Package - 42”	CMFL4224P_	724	805	42	24	2 3/8
		CMFL4230P_	877	971	42	30	2 3/8
		CMFL4236P_	983	1093	42	36	2 3/8
		CMFL4242P_	1089	1211	42	42	2 3/8
		CMFL4248P_	1182	1315	42	48	2 3/8
		CMFL4254P_	1281	1431	42	54	2 3/8
		CMFL4260P_	1384	1546	42	60	2 3/8
	Powered Compile Single Segmented Laminate Panel Package - 48”	CMFL4824P_	828	848	48	24	2 3/8
		CMFL4830P_	998	1021	48	30	2 3/8
		CMFL4836P_	1123	1151	48	36	2 3/8
		CMFL4842P_	1246	1276	48	42	2 3/8
		CMFL4848P_	1357	1392	48	48	2 3/8
		CMFL4854P_	1481	1520	48	54	2 3/8
		CMFL4860P_	1604	1648	48	60	2 3/8
	Powered Compile Single Segmented Laminate Panel Package - 54”	CMFL5424P_	829	927	54	24	2 3/8
		CMFL5430P_	998	1114	54	30	2 3/8
		CMFL5436P_	1123	1252	54	36	2 3/8
		CMFL5442P_	1246	1395	54	42	2 3/8
		CMFL5448P_	1357	1519	54	48	2 3/8
		CMFL5454P_	1482	1659	54	54	2 3/8
		CMFL5460P_	1604	1801	54	60	2 3/8
	Powered Compile Single Segmented Laminate Panel Package - 66”	CMFL6624P_	985	1107	66	24	2 3/8
		CMFL6630P_	1177	1319	66	30	2 3/8
		CMFL6636P_	1297	1502	66	36	2 3/8
		CMFL6642P_	1492	1675	66	42	2 3/8
		CMFL6648P_	1623	1821	66	48	2 3/8
		CMFL6654P_	1780	2003	66	54	2 3/8
		CMFL6660P_	1934	2177	66	60	2 3/8

**Raceway Cover Options (1) Shown**

- **RACEWAY COVER OPTIONS (Suffix)**
  - (1) Knockouts Side 1 – No Knockout Side 2
  - (2) Knockouts Side 1 and Side 2

**CMLLXXYYN - SEGMENTED LAMINATE DOUBLE SIDED PANEL – NON-POWERED**

- Individual laminate covered modules incorporated into an aluminum frame. same height.
- Modules have laminate on one side and fabric on the other.
- Opposite sides of each module may have a different laminate within the same grade at no upcharge.
- If different grades of fabric are used on one panel, the entire panel must be priced at highest grade.
- Note: Trim is not required at a straight connection between two panels of the
- 3 Panel connector brackets per side come standard with 42”h, 48h” and 54”h panels.
- 4 Panel connector brackets per side come standard with 66”h panels.
- 24” wide panels have two punchouts, one for electrical and one for data.
- 30” wide panels and wider have three punchouts, two for electrical and one for data.

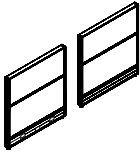
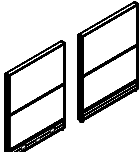
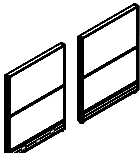
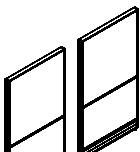
	DESCRIPTION	PRODUCT CODE	LIST PRICE Gr1	DIMENSIONS/INCHES		
				H	W	D
	Non-Powered Compile Single Segmented	CMLL4224N_	636	42	24	2 3/8
	Double Sided Laminate Panel Package - 42”	CMLL4230N_	748	42	30	2 3/8
		CMLL4236N_	871	42	36	2 3/8
		CMLL4242N_	993	42	42	2 3/8
		CMLL4248N_	1112	42	48	2 3/8
		CMLL4254N_	1222	42	54	2 3/8
		CMLL4260N_	1329	42	60	2 3/8
	Non-Powered Compile Single Segmented	CMLL4824N_	752	48	24	2 3/8
	Double Sided Laminate Panel Package - 48”	CMLL4830N_	891	48	30	2 3/8
		CMLL4836N_	1033	48	36	2 3/8
		CMLL4842N_	1181	48	42	2 3/8
		CMLL4848N_	1327	48	48	2 3/8
		CMLL4854N_	1462	48	54	2 3/8
		CMLL4860N_	1589	48	60	2 3/8
	Non-Powered Compile Single Segmented	CMLL5424N_	752	54	24	2 3/8
	Double Sided Laminate Panel Package - 54”	CMLL5430N_	891	54	30	2 3/8
		CMLL5436N_	1034	54	36	2 3/8
		CMLL5442N_	1182	54	42	2 3/8
		CMLL5448N_	1328	54	48	2 3/8
		CMLL5454N_	1462	54	54	2 3/8
		CMLL5460N_	1592	54	60	2 3/8
	Non-Powered Compile Single Segmented	CMLL6624N_	952	66	24	2 3/8
	Double Sided Laminate Panel Package - 66”	CMLL6630N_	1124	66	30	2 3/8
		CMLL6636N_	1304	66	36	2 3/8
		CMLL6642N_	1493	66	42	2 3/8
		CMLL6648N_	1675	66	48	2 3/8
		CMLL6654N_	1847	66	54	2 3/8
		CMLL6660N_	2020	66	60	2 3/8

**Raceway Cover Options (1) Shown**

- RACEWAY COVER OPTIONS (Suffix)**
  - (0) No Knockouts Side 1 and Side 2
  - (1) Knockouts Side 1 – No Knockout Side 2
  - (2) Knockouts Side 1 and Side 2

**CMLLXXYP\_ - SEGMENTED LAMINATE DOUBLE SIDED PANEL – POWERED**

- Individual laminate covered modules incorporated into an aluminum frame.
- Modules have laminate on one side and fabric on the other.
- Opposite sides of each module may have a different laminate within the same grade at no upcharge.
- If different grades of fabric are used on one panel, the entire panel must be priced at highest grade.
- Note: Trim is not required at a straight connection between two panels of the same height.
- 3 Panel connector brackets per side come standard with 42”h, 48h” and 54”h panels.
- 4 Panel connector brackets per side come standard with 66” panels.
- 24” wide panels have two punchouts, one for electrical and one for data.
- 30” wide panels and wider have three punchouts, two for electrical and one for data.

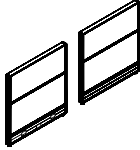
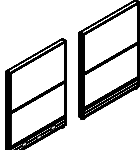
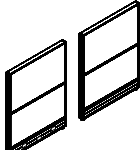
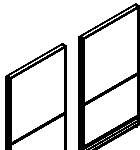

	DESCRIPTION	PRODUCT CODE	LIST PRICE Gr1	DIMENSIONS/INCHES		
				H	W	D
	Powered Compile Single Segmented	CMLL4224P_	801	42	24	2.38
	Double Sided Laminate Panel Package - 42”	CMLL4230P_	970	42	30	2.38
		CMLL4236P_	1105	42	36	2.38
		CMLL4242P_	1231	42	42	2.38
		CMLL4248P_	1366	42	48	2.38
		CMLL4254P_	1480	42	54	2.38
		CMLL4260P_	1587	42	60	2.38
	Powered Compile Single Segmented	CMLL4824P_	915	48	24	2.38
	Double Sided Laminate Panel Package - 48”	CMLL4830P_	1111	48	30	2.38
		CMLL4836P_	1266	48	36	2.38
		CMLL4842P_	1418	48	42	2.38
		CMLL4848P_	1583	48	48	2.38
		CMLL4854P_	1719	48	54	2.38
		CMLL4860P_	1848	48	60	2.38
	Powered Compile Single Segmented	CMLL5424P_	915	54	24	2.38
	Double Sided Laminate Panel Package - 54”	CMLL5430P_	1112	54	30	2.38
		CMLL5436P_	1266	54	36	2.38
		CMLL5442P_	1418	54	42	2.38
		CMLL5448P_	1584	54	48	2.38
		CMLL5454P_	1721	54	54	2.38
		CMLL5460P_	1848	54	60	2.38
	Powered Compile Single Segmented	CMLL6624P_	1115	66	24	2.38
	Double Sided Laminate Panel Package - 66”	CMLL6630P_	1347	66	30	2.38
		CMLL6636P_	1536	66	36	2.38
		CMLL6642P_	1731	66	42	2.38
		CMLL6648P_	1929	66	48	2.38
		CMLL6654P_	2104	66	54	2.38
		CMLL6660P_	2277	66	60	2.38

**Raceway Cover Options (1) Shown**

- **RACEWAY COVER OPTIONS (Suffix)**
  - (0) No Knockouts Side 1 and Side 2
  - (1) Knockouts Side 1 – No Knockout Side 2
  - (2) Knockouts Side 1 and Side 2

**CMFWXXYYN\_ - SEGMENTED WRITE BOARD SINGLE SIDED PANEL – NON-POWERED**

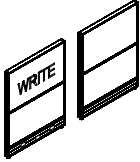
- Individual fabric or write board covered modules incorporated into an aluminum frame.
- Modules have write board on one side and fabric on the other at the top and fabric on two sides at the bottom.
- Opposite sides of each module may have a different fabric within the same grade at no upcharge.
- If different grades of fabric are used on one panel, the entire panel must be priced at highest grade.
- Panels are not tackable.
- Note: Trim is not required at a straight connection between two panels of the same height.
- 3 Panel connector brackets per side come standard with 48”h. and 54”h. panels.
- 4 Panel connector brackets per side come standard with 66”h. panels.
- 24” wide panels have two punchouts, one for electrical and one for data.
- 30” wide panels and wider have three punchouts, two for electrical and one for data.

	DESCRIPTION	PRODUCT CODE	LIST PRICE		DIMENSIONS/INCHES		
			Gr1	Gr2	H	W	D
	Non-Powered Compile Write Board Single Sided Panel Package - 48” No punchouts	CMFW4824N_	594	623	48	24	2 3/8
		CMFW4830N_	717	752	48	30	2 3/8
		CMFW4836N_	796	835	48	36	2 3/8
		CMFW4842N_	897	752	48	42	2 3/8
		CMFW4848N_	1008	1060	48	48	2 3/8
		CMFW4854N_	1121	1161	48	54	2 3/8
		CMFW4860N_	1233	1300	48	60	2 3/8
	Non-Powered Compile Write Board Single Sided Panel Package - 54”	CMFW5424N_	595	619	54	24	2 3/8
		CMFW5430N_	718	745	54	30	2 3/8
		CMFW5436N_	797	823	54	36	2 3/8
		CMFW5442N_	898	931	54	42	2 3/8
		CMFW5448N_	1010	1046	54	48	2 3/8
		CMFW5454N_	1121	1159	54	54	2 3/8
		CMFW5460N_	1234	1276	54	60	2 3/8
	Non-Powered Compile Write Board Single Sided Panel Package - 66”	CMFW6624N_	749	777	66	24	2 3/8
		CMFW6630N_	891	924	66	30	2 3/8
		CMFW6636N_	992	1027	66	36	2 3/8
		CMFW6642N_	1122	1160	66	42	2 3/8
		CMFW6648N_	1251	1296	66	48	2 3/8
		CMFW6654N_	1391	1439	66	54	2 3/8
		CMFW6660N_	1536	1588	66	60	2 3/8

**Raceway Cover Options (1) Shown**

- **RACEWAY COVER OPTIONS (Suffix)**
  - (0) No Knockouts Side 1 and Side 2
  - (1) Knockouts Side 1 – No Knockout Side 2
  - (2) Knockouts Side 1 and Side 2

**CMFWXXYYP\_ - SEGMENTED WRITE BOARD SINGLE SIDED PANEL – POWERED**

- Individual fabric or write board covered modules incorporated into an aluminum frame.
- Modules have write board on one side and fabric on the other at the top and fabric on two sides at the bottom.
- Opposite sides of each module may have a different fabric within the same grade at no upcharge.
- If different grades of fabric are used on one panel, the entire panel must be priced at highest grade.
- Panels are not tackable.
- Note: Trim is not required at a straight connection between two panels of the same height.
- 3 Panel connector brackets per side come standard with 48”h. and 54”h. panels.
- 4 Panel connector brackets per side come standard with 66”h. panels.
- 24” wide panels have two punchouts, one for electrical and one for data.
- 30” wide panels and wider have three punchouts, two for electrical and one for data.

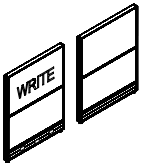
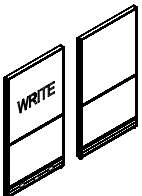

	DESCRIPTION	PRODUCT CODE	LIST PRICE		DIMENSIONS/INCHES		
			Gr1	Gr2	H	W	D
	Powered Compile Write Board Single Sided Panel Package - 48” Punchouts on one side	CMFW4824P_	757	786	48	24	2 3/8
		CMFW4830P_	939	974	48	30	2 3/8
		CMFW4836P_	1027	1066	48	36	2 3/8
		CMFW4842P_	1133	1183	48	42	2 3/8
		CMFW4848P_	1263	1313	48	48	2 3/8
		CMFW4854P_	1378	1417	48	54	2 3/8
		CMFW4860P_	1491	1557	48	60	2 3/8
	Powered Compile Write Board Single Sided Panel Package - 54”	CMFW5424P_	759	783	54	24	2 3/8
		CMFW5430P_	940	967	54	30	2 3/8
		CMFW5436P_	1027	1054	54	36	2 3/8
		CMFW5442P_	1134	1167	54	42	2 3/8
		CMFW5448P_	1263	1299	54	48	2 3/8
		CMFW5454P_	1380	1418	54	54	2 3/8
		CMFW5460P_	1491	1536	54	60	2 3/8
	Powered Compile Write Board Single Sided Panel Package - 66”	CMFW6624P_	914	941	66	24	2 3/8
		CMFW6630P_	1112	1145	66	30	2 3/8
		CMFW6636P_	1222	1257	66	36	2 3/8
		CMFW6642P_	1358	1396	66	42	2 3/8
		CMFW6648P_	1507	1549	66	48	2 3/8
		CMFW6654P_	1647	1697	66	54	2 3/8
		CMFW6660P_	1795	1849	66	60	2 3/8

**Raceway Cover Options (1) Shown**

- **RACEWAY COVER OPTIONS (Suffix)**
  - (0) No Knockouts Side 1 and Side 2
  - (1) Knockouts Side 1 – No Knockout Side 2
  - (2) Knockouts Side 1 and Side 2

**CMWWXXYYN\_ - SEGMENTED WRITE BOARD DOUBLE SIDED PANEL – NON-POWERED**

- Individual fabric or write board covered modules incorporated into an aluminum frame.
- Modules have write board on two sides at the top and fabric on two sides at the bottom.
- Opposite sides of each module may have a different fabric within the same grade at no upcharge.
- If different grades of fabric are used on one panel, the entire panel must be priced at highest grade.
- Panels are not tackable.
- Note: Trim is not required at a straight connection between two panels of the same height.
- 3 Panel connector brackets per side come standard with 48”h. and 54”h. panels.
- 4 Panel connector brackets per side come standard with 66”h. panels.
- 24” wide panels have two punchouts, one for electrical and one for data.
- 30” wide panels and wider have three punchouts, two for electrical and one for data.



	DESCRIPTION	PRODUCT CODE	LIST PRICE		DIMENSIONS/INCHES		
			Gr1	Gr2	H	W	D
	Non-Powered Compile Write Board	CMWW4824N_	651	670	48	24	2.38
	Single Segmented Panel Package - 48"	CMWW4830N_	808	831	48	30	2.38
	No Punchouts	CMWW4836N_	875	907	48	36	2.38
		CMWW4842N_	992	1025	48	42	2.38
		CMWW4848N_	1161	1197	48	48	2.38
		CMWW4854N_	1289	1329	48	54	2.38
		CMWW4860N_	1420	1461	48	60	2.38
	Non-Powered Compile Write Board	CMWW5424N_	652	688	54	24	2.38
	Single Segmented Panel Package - 54"	CMWW5430N_	808	844	54	30	2.38
		CMWW5436N_	875	944	54	36	2.38
		CMWW5442N_	993	1062	54	42	2.38
		CMWW5448N_	1161	1230	54	48	2.38
		CMWW5454N_	1290	1359	54	54	2.38
		CMWW5460N_	1420	1489	54	60	2.38
	Non-Powered Compile Write Board	CMWW6624N_	804	840	66	24	2.38
	Single Segmented Panel Package - 66"	CMWW6630N_	985	1021	66	30	2.38
		CMWW6636N_	992	1061	66	36	2.38
		CMWW6642N_	1218	1288	66	42	2.38
		CMWW6648N_	1400	1469	66	48	2.38
		CMWW6654N_	1563	1632	66	54	2.38
		CMWW6660N_	1723	1792	66	60	2.38

**Raceway Cover Options (1) Shown**

- **RACEWAY COVER OPTIONS (Suffix)**
  - (0) No Knockouts Side 1 and Side 2
  - (1) Knockouts Side 1 – No Knockout Side 2
  - (2) Knockouts Side 1 and Side 2

**CMWWXYYP\_ - SEGMENTED WRITE BOARD DOUBLE SIDED PANEL – POWERED**

- Individual fabric or write board covered modules incorporated into an aluminum frame.
- Modules have write board on two sides at the top and fabric on two sides at the bottom.
- Opposite sides of each module may have a different fabric within the same grade at no upcharge.
- If different grades of fabric are used on one panel, the entire panel must be priced at highest grade.
- Panels are not tackable.
- Note: Trim is not required at a straight connection between two panels of the same height.
- 3 Panel connector brackets per side come standard with 48”h. and 54”h. panels.
- 4 Panel connector brackets per side come standard with 66”h. panels.
- 24” wide panels have two punchouts, one for electrical and one for data.
- 30” wide panels and wider have three punchouts, two for electrical and one for data.

	DESCRIPTION	PRODUCT CODE	LIST PRICE		DIMENSIONS/INCHES		
			Gr1	Gr2	H	W	D
	Powered Compile Write Board	CMWW4824P_	815	835	48	24	2 3/8
	Single Segmented Panel Package - 48"	CMWW4830P_	1029	1052	48	30	2 3/8
	Punchouts on one side	CMWW4836P_	1107	1136	48	36	2 3/8
		CMWW4842P_	1230	1262	48	42	2 3/8
		CMWW4848P_	1415	1451	48	48	2 3/8
		CMWW4854P_	1546	1586	48	54	2 3/8
		CMWW4860P_	1678	1718	48	60	2 3/8
	Powered Compile Write Board	CMWW5424P_	815	851	54	24	2 3/8
	Single Segmented Panel Package - 54"	CMWW5430P_	1029	1065	54	30	2 3/8
		CMWW5436P_	1107	1176	54	36	2 3/8
		CMWW5442P_	1231	1300	54	42	2 3/8
		CMWW5448P_	1415	1484	54	48	2 3/8
		CMWW5454P_	1547	1616	54	54	2 3/8
		CMWW5460P_	1678	1747	54	60	2 3/8
	Powered Compile Write Board	CMWW6624P_	966	1002	66	24	2 3/8
	Single Segmented Panel Package - 66"	CMWW6630P_	1204	1240	66	30	2 3/8
		CMWW6636P_	1305	1374	66	36	2 3/8
		CMWW6642P_	1454	1523	66	42	2 3/8
		CMWW6648P_	1656	1725	66	48	2 3/8
		CMWW6654P_	1819	1888	66	54	2 3/8
		CMWW6660P_	1981	2050	66	60	2 3/8

**Raceway Cover Options (1) Shown**

- **RACEWAY COVER OPTIONS (Suffix)**
  - (0) No Knockouts Side 1 and Side 2
  - (1) Knockouts Side 1 – No Knockout Side 2
  - (2) Knockouts Side 1 and Side 2

**CMFOXXYYN\_ - COMPILE SINGLE SEGMENTED OPEN BOTTOM PANEL PACKAGE – NON-POWERED**

- Non powered.
- Includes one panel and two raceways covers with no punchouts and a integrated aluminum top cap.
- Individual fabric-covered module in upper position incorporated into an aluminum frame. Bottom is open.
- Opposite sides of each module may have a different fabric within the same grade at no upcharge.
- If different grades of fabric are used on one panel, the entire panel must be priced at highest grade.
- Panels are not tackable or acoustical.
- Trim is not required at a straight connection between two panels of the same height.
- 3 Panel connector brackets per side come standard with 42”h, 48”h and 54”h panels.
- 4 Panel connector brackets per side come standard with 66”h panels.
- Panels contain leveling glides. Maximum extension of glides is 2”.

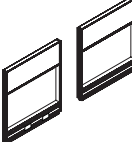
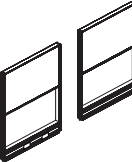
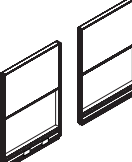
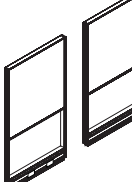

	DESCRIPTION	PRODUCT CODE	LIST PRICE		DIMENSIONS/INCHES		
			Gr1	Gr2	H	W	D
	Non-Powered Compile Single Segmented Open Bottom Panel Package - 42"	CMFO4224N_	380	398	42	24	2 3/8
		CMFO4230N_	426	441	42	30	2 3/8
		CMFO4236N_	452	481	42	36	2 3/8
		CMFO4242N_	516	545	42	42	2 3/8
		CMFO4248N_	549	578	42	48	2 3/8
		CMFO4254N_	613	628	42	54	2 3/8
		CMFO4260N_	654	683	42	60	2 3/8
	Non-Powered Compile Single Segmented Open Bottom Panel Package - 48"	CMFO4824N_	410	433	48	24	2 3/8
		CMFO4830N_	460	480	48	30	2 3/8
		CMFO4836N_	516	537	48	36	2 3/8
		CMFO4842N_	586	626	48	42	2 3/8
		CMFO4848N_	632	673	48	48	2 3/8
		CMFO4854N_	671	712	48	54	2 3/8
		CMFO4860N_	723	764	48	60	2 3/8
	Non-Powered Compile Single Segmented Open Bottom Panel Package - 54"	CMFO5424N_	411	435	54	24	2 3/8
		CMFO5430N_	460	484	54	30	2 3/8
		CMFO5436N_	517	541	54	36	2 3/8
		CMFO5442N_	586	627	54	42	2 3/8
		CMFO5448N_	632	673	54	48	2 3/8
		CMFO5454N_	671	713	54	54	2 3/8
		CMFO5460N_	724	765	54	60	2 3/8
	Non-Powered Compile Single Segmented Open Bottom Panel Package - 66"	CMFO6624N_	482	517	66	24	2 3/8
		CMFO6630N_	553	588	66	30	2 3/8
		CMFO6636N_	615	676	66	36	2 3/8
		CMFO6642N_	699	762	66	42	2 3/8
		CMFO6648N_	740	803	66	48	2 3/8
		CMFO6654N_	804	865	66	54	2 3/8
		CMFO6660N_	852	913	66	60	2 3/8

**Raceway Cover Options (1) Shown**

- **RACEWAY COVER OPTIONS (Suffix)**
  - (0) No Knockouts Side 1 and Side 2
  - (1) Knockouts Side 1 – No Knockout Side 2
  - (2) Knockouts Side 1 and Side 2

**CMFOXXYP - COMPILE SINGLE SEGMENTED - OPEN BOTTOM PANEL PACKAGE – POWERED**

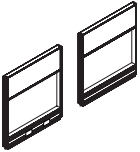
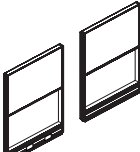
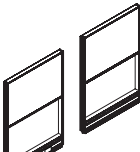
- With power distribution harness.
- Includes one panel, power harness, one raceway cover with punchout, one raceway cover without punchout and a integrated aluminum top cap.
- Individual fabric-covered module in upper position incorporated into an aluminum frame. Bottom is open.
- Opposite sides of each module may have a different fabric within the same grade at no upcharge.
- If different grades of fabric are used on one panel, the entire panel must be priced at highest grade.
- Panels are not tackable or acoustical.
- Trim is not required at a straight connection between two panels of the same height.
- 3 Panel connector brackets per side come standard with 42”h, 48”h and 54”h panels.
- 4 Panel connector brackets per side come standard with 66”h panels.
- Panels contain leveling glides. Maximum extension of glides is 2”.
- 24” wide panels have one punchout, 30” wide panels or wider have two punchouts.

	DESCRIPTION	PRODUCT CODE	LIST PRICE		DIMENSIONS/INCHES		
			Gr1	Gr2	H	W	D
	Powered Compile Single Segmented Open Bottom Panel Package - 42”	CMFO4224P_	529	547	42	24	2 3/8
		CMFO4230P_	630	648	42	30	2 3/8
		CMFO4236P_	664	693	42	36	2 3/8
		CMFO4242P_	733	762	42	42	2 3/8
		CMFO4248P_	782	811	42	48	2 3/8
		CMFO4254P_	847	862	42	54	2 3/8
	Powered Compile Single Segmented Open Bottom Panel Package - 48”	CMFO4824P_	562	585	48	24	2 3/8
		CMFO4830P_	660	681	48	30	2 3/8
		CMFO4836P_	732	753	48	36	2 3/8
		CMFO4842P_	803	844	48	42	2 3/8
		CMFO4848P_	866	907	48	48	2 3/8
		CMFO4854P_	907	948	48	54	2 3/8
	Powered Compile Single Segmented Open Bottom Panel Package - 54”	CMFO5424P_	562	586	54	24	2 3/8
		CMFO5430P_	663	686	54	30	2 3/8
		CMFO5436P_	732	756	54	36	2 3/8
		CMFO5442P_	804	846	54	42	2 3/8
		CMFO5448P_	868	910	54	48	2 3/8
		CMFO5454P_	910	951	54	54	2 3/8
	Powered Compile Single Segmented Open Bottom Panel Package - 66”	CMFO6624P_	633	667	66	24	2 3/8
		CMFO6630P_	754	789	6	30	2 3/8
		CMFO6636P_	828	891	66	36	2 3/8
		CMFO6642P_	915	976	66	42	2 3/8
		CMFO6648P_	972	1035	66	48	2 3/8
		CMFO6654P_	1039	1100	66	54	2 3/8
CMFO6660P_	1091	1154	66	60	2 3/8		

**Raceway Cover Options (1) Shown**

- **RACEWAY COVER OPTIONS (Suffix)**
  - (1) Knockouts Side 1 – No Knockout Side 2
  - (2) Knockouts Side 1 and Side 2

**CMFGXXYYN\_ - COMPILE GLAZED PANEL PACKAGE – NON-POWERED**

- Non powered.
- Includes one panel and two raceway covers with no punchouts.
- Individual fabric-covered module in lower position incorporated into a solid steel frame.
- Opposite sides of each module may have a different fabric within the same grade at no upcharge.
- If different grades of fabric are used on one panel, the entire panel must be priced at highest grade.
- Panels are not tackable or acoustical.
- Trim is not required at a straight connection between two panels of the same height.
- 3 Panel connector brackets per side come standard with 42”h, 48”h and 54”h panels.
- 4 Panel connector brackets per side come standard with 66”h panels.
- Panels contain leveling glides. Maximum extension of glides is 2”.
- Standard clear (CLR) plexi.
- Optional Frosted Plexi with 10% upcharge.
- PVC glass retainer in matching paint color.
- Glazing starts at 29” high to the top of the panel.

	DESCRIPTION	PRODUCT CODE	LIST PRICE		DIMENSIONS/INCHES		
			Gr1	Gr2	H	W	D
	Non-Powered Compile Glazed Panel Package - 42"	CMFG4224N_	514	534	42	24	2.38
		CMFG4230N_	586	609	42	30	2.38
		CMFG4236N_	655	683	42	36	2.38
		CMFG4242N_	732	764	42	42	2.38
		CMFG4248N_	801	834	42	48	2.38
		CMFG4254N_	900	935	42	54	2.38
		CMFG4260N_	992	1032	42	60	2.38
	Non-Powered Compile Glazed Panel Package - 48"	CMFG4824N_	553	573	48	24	2.38
		CMFG4830N_	647	670	48	30	2.38
		CMFG4836N_	736	763	48	36	2.38
		CMFG4842N_	824	853	48	42	2.38
		CMFG4848N_	899	932	48	48	2.38
		CMFG4854N_	1047	1083	48	54	2.38
		CMFG4860N_	1184	1226	48	60	2.38
	Non-Powered Compile Glazed Panel Package - 54"	CMFG5424N_	554	577	54	24	2.38
		CMFG5430N_	650	674	54	30	2.38
		CMFG5436N_	736	764	54	36	2.38
		CMFG5442N_	828	857	54	42	2.38
		CMFG5448N_	900	934	54	48	2.38
		CMFG5454N_	1048	1084	54	54	2.38
		CMFG5460N_	1185	1227	54	60	2.38
	Non-Powered Compile Glazed Panel Package - 66"	CMFG6624N_	694	723	66	24	2.38
		CMFG6630N_	806	840	66	30	2.38
		CMFG6636N_	919	955	66	36	2.38
		CMFG6642N_	1034	1081	66	42	2.38
		CMFG6648N_	1122	1173	66	48	2.38
		CMFG6654N_	1298	1353	66	54	2.38
		CMFG6660N_	1465	1523	66	60	2.38

**Raceway Cover Options (1) Shown**

- **RACEWAY COVER OPTIONS (Suffix)**
  - (0) No Knockouts Side 1 and Side 2
  - (1) Knockouts Side 1 – No Knockout Side 2
  - (2) Knockouts Side 1 and Side 2

**CMFGXXYP - COMPILE GLAZED PANEL PACKAGE – POWERED**

- With power distribution harness.
- Includes one panel, power harness, one raceway cover with punchout and one raceway cover with no punchout.
- Individual fabric-covered modules incorporated into an aluminum frame.
- Opposite sides of each module may have a different fabric within the same grade at no upcharge.
- If different grades of fabric are used on one panel, the entire panel must be priced at highest grade.
- Panels are not tackable or acoustical.
- Trim is not required at a straight connection between two panels of the same height.
- 3 Panel connector brackets per side come standard with 42”h, 48”h and 54”h panels.
- 4 Panel connector brackets per side come standard with 66”h panels.
- Panels contain leveling glides. Maximum extension of glides is 2”.
- Standard clear (CLR) plexi.
- Optional Frosted Plexi with 10% upcharge.
- PVC glass retainer in matching paint color.
- Glazing starts at 29” high to the top of the panel.

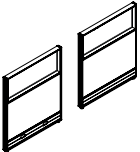
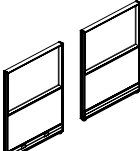
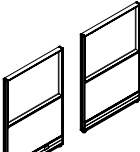
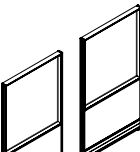
	DESCRIPTION	PRODUCT CODE	LIST PRICE		DIMENSIONS/INCHES		
			Gr1	Gr2	H	W	D
	Powered Compile Glazed Panel Package - 42"	CMFG4224P_	677	697	42	24	2 3/8
		CMFG4230P_	806	829	42	30	2 3/8
		CMFG4236P_	888	916	42	36	2 3/8
		CMFG4242P_	966	998	42	42	2 3/8
		CMFG4248P_	1054	1087	42	48	2 3/8
		CMFG4254P_	1154	1189	42	54	2 3/8
		CMFG4260P_	1247	1287	42	60	2 3/8
	Powered Compile Glazed Panel Package - 48"	CMFG4824P_	715	736	48	24	2 3/8
		CMFG4830P_	866	889	48	30	2 3/8
		CMFG4836P_	966	994	48	36	2 3/8
		CMFG4842P_	1062	1090	48	42	2 3/8
		CMFG4848P_	1152	1186	48	48	2 3/8
		CMFG4854P_	1302	1338	48	54	2 3/8
		CMFG4860P_	1442	1483	48	60	2 3/8
	Powered Compile Glazed Panel Package - 54"	CMFG5424P_	715	738	54	24	2 3/8
		CMFG5430P_	868	892	54	30	2 3/8
		CMFG5436P_	966	994	54	36	2 3/8
		CMFG5442P_	1062	1091	54	42	2 3/8
		CMFG5448P_	1153	1187	54	48	2 3/8
		CMFG5454P_	1303	1339	54	54	2 3/8
		CMFG5460P_	1443	1485	54	60	2 3/8
	Powered Compile Glazed Panel Package - 66"	CMFG6624P_	858	887	66	24	2 3/8
		CMFG6630P_	1027	1061	66	30	2 3/8
		CMFG6636P_	1151	1187	66	36	2 3/8
		CMFG6642P_	1271	1318	66	42	2 3/8
		CMFG6648P_	1380	1431	66	48	2 3/8
		CMFG6654P_	1552	1607	66	54	2 3/8
		CMFG6660P_	1725	1783	66	60	2 3/8

**Raceway Cover Options (1) Shown**

- **RACEWAY COVER OPTIONS (Suffix)**
  - (1) Knockouts Side 1 – No Knockout Side 2
  - (2) Knockouts Side 1 and Side 2

**CMPGXXYYN\_ - COMPILE PARTLY GLAZED PANEL PACKAGE – NON-POWERED**

- Non powered.
- Includes one panel and two raceway covers with no punchouts.
- Individual fabric-covered module in lower position incorporated into a solid steel frame.
- Opposite sides of each module may have a different fabric within the same grade at no upcharge.
- If different grades of fabric are used on one panel, the entire panel must be priced at highest grade.
- Panels are not tackable or acoustical.
- Trim is not required at a straight connection between two panels of the same height.
- 3 Panel connector brackets per side come standard with 48”h and 54”h panels.
- 4 Panel connector brackets per side come standard with 66”h panels.
- Panels contain leveling glides. Maximum extension of glides is 2”.
- Standard clear (CLR) plexi.
- Optional Frosted Plexi with 10% upcharge.
- PVC glass retainer in matching paint color.
- Glazing is 14” nominal from the top of the panel.

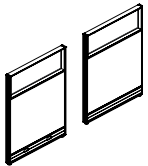
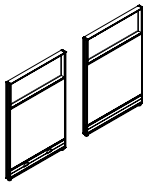
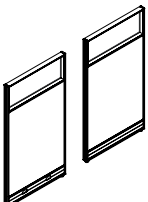
	DESCRIPTION	PRODUCT CODE	LIST PRICE		DIMENSIONS/INCHES		
			Gr1	Gr2	H	W	D
	Non-Powered Compile Partly Glazed Panel Package - 48"	CMPG4824N_	589	634	48	24	2 3/8
		CMPG4830N_	679	737	48	30	2 3/8
		CMPG4836N_	757	816	48	36	2 3/8
		CMPG4842N_	843	918	48	42	2 3/8
		CMPG4848N_	929	1018	48	48	2 3/8
		CMPG4854N_	1027	1118	48	54	2 3/8
		CMPG4860N_	1115	1216	48	60	2 3/8
	Non-Powered Compile Partly Glazed Panel Package - 54"	CMPG5424N_	589	636	54	24	2 3/8
		CMPG5430N_	679	738	54	30	2 3/8
		CMPG5436N_	759	820	54	36	2 3/8
		CMPG5442N_	844	918	54	42	2 3/8
		CMPG5448N_	929	1018	54	48	2 3/8
		CMPG5454N_	1027	1120	54	54	2 3/8
		CMPG5460N_	1117	1219	54	60	2 3/8
	Non-Powered Compile Partly Glazed Panel Package - 66"	CMPG6624N_	647	698	66	24	2 3/8
		CMPG6630N_	741	802	66	30	2 3/8
		CMPG6636N_	831	987	66	36	2 3/8
		CMPG6642N_	925	999	66	42	2 3/8
		CMPG6648N_	1022	1110	66	48	2 3/8
		CMPG6654N_	1126	1216	66	54	2 3/8
		CMPG6660N_	1227	1325	66	60	2 3/8

**Raceway Cover Options (1) Shown**

- **RACEWAY COVER OPTIONS (Suffix)**
  - (0) No Knockouts Side 1 and Side 2
  - (1) Knockouts Side 1 – No Knockout Side 2
  - (2) Knockouts Side 1 and Side 2

**CMPGXXYP\_ - COMPILER PARTLY GLAZED PANEL PACKAGE – POWERED**

- With power distribution harness.
- Includes one panel, power harness, one raceway cover with punchout and one raceway cover with no punchout.
- Individual fabric-covered modules incorporated into an aluminum frame.
- Opposite sides of each module may have a different fabric within the same grade at no upcharge.
- If different grades of fabric are used on one panel, the entire panel must be priced at highest grade.
- Panels are not tackable or acoustical.
- Trim is not required at a straight connection between two panels of the same height.
- 3 Panel connector brackets per side come standard with 48”h and 54”h panels.
- 4 Panel connector brackets per side come standard with 66”h panels.
- Panels contain leveling glides. Maximum extension of glides is 2”.
- Standard clear (CLR) plexi.
- Optional Frosted Plexi with 10% upcharge.
- PVC glass retainer in matching paint color.
- Glazing is 14” nominal from the top of the panel.

	DESCRIPTION	PRODUCT CODE	LIST PRICE		DIMENSIONS/INCHES		
			Gr1	Gr2	H	W	D
	Powered Compile Partly Glazed Panel Package - 48"	CMPG4824P_	754	800	48	24	2 3/8
		CMPG4830P_	900	958	48	2 3/8	
		CMPG4836P_	988	1047	48	36	2 3/8
		CMPG4842P_	1079	1152	48	42	2 3/8
		CMPG4848P_	1185	1273	48	48	2 3/8
		CMPG4854P_	1281	1374	48	54	2 3/8
		CMPG4860P_	1372	1474	48	60	2 3/8
	Powered Compile Partly Glazed Panel Package - 54"	CMPG5424P_	754	801	54	24	2 3/8
		CMPG5430P_	901	960	54	30	2 3/8
		CMPG5436P_	989	1050	54	36	2 3/8
		CMPG5442P_	1079	1153	54	42	2 3/8
		CMPG5448P_	1186	1275	54	48	2 3/8
		CMPG5454P_	1282	1375	54	54	2 3/8
		CMPG5460P_	1372	1474	54	60	2 3/8
	Powered Compile Partly Glazed Panel Package - 66"	CMPG6624P_	808	859	66	24	2 3/8
		CMPG6630P_	961	1022	66	30	2 3/8
		CMPG6636P_	1062	1218	66	36	2 3/8
		CMPG6642P_	1161	1235	66	42	2 3/8
		CMPG6648P_	1276	1364	66	48	2 3/8
		CMPG6654P_	1384	1474	66	54	2 3/8
		CMPG6660P_	1484	1582	66	60	2 3/8

**Raceway Cover Options (1) Shown**

- **RACEWAY COVER OPTIONS (Suffix)**
  - (1) Knockouts Side 1 – No Knockout Side 2
  - (2) Knockouts Side 1 and Side 2

**CMPLGXXYYN - SINGLE 12" GLAZED AT TOP PANEL - NON-POWERED**

- Individual fabric-covered module in lower position with 12" H glazed module in upper position incorporated into an aluminum frame.
- Opposite sides of each module may have a different fabric within the same grade at no upcharge.
- If different grades of fabric are used on one panel, the entire panel must be priced at highest grade.
- Panels are not tackable.
- Note: Trim is not required at a straight connection between two panels of the same height.
- 3 Panel connector brackets per side come standard with 42"h, 48"h and 54"h

- panels.
- 4 Panel connector brackets per side come standard with 66"h. panels.
- Standard clear (CLR) plexi.
- Optional Frosted Plexi with 10% upcharge.
- 24" wide panels have two punchouts, one for electrical and one for data.
- 30" wide panels and wider have three punchouts, two for electrical and one for data.
- Glazing is 12" nominal from the top of the panel.

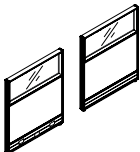
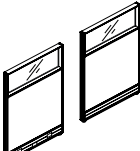
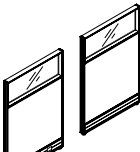
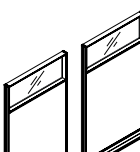
	DESCRIPTION	PRODUCT CODE	LIST PRICE		DIMENSIONS/INCHES		
			Gr1	Gr2	H	W	D
	Non-Powered Compile 12" Top Glazed Single Segmented Panel Package - 42"	CMPLG4224N_	564	585	42	24	2 3/8
		CMPLG4230N_	660	681	42	30	2 3/8
		CMPLG4236N_	757	798	42	36	2 3/8
		CMPLG4242N_	843	883	42	42	2 3/8
		CMPLG4248N_	915	956	42	48	2 3/8
		CMPLG4254N_	1022	1063	42	54	2 3/8
		CMPLG4260N_	1122	1163	42	60	2 3/8
	Non-Powered Compile 12" Top Glazed Single Segmented Panel Package - 48"	CMPLG4824N_	577	596	48	24	2 3/8
		CMPLG4830N_	665	685	48	30	2 3/8
		CMPLG4836N_	742	781	48	36	2 3/8
		CMPLG4842N_	824	863	48	42	2 3/8
		CMPLG4848N_	903	942	48	48	2 3/8
		CMPLG4854N_	1008	1044	48	54	2 3/8
		CMPLG4860N_	1094	1133	48	60	2 3/8
	Non-Powered Compile 12" Top Glazed Single Segmented Panel Package - 54"	CMPLG5424N_	580	603	54	24	2 3/8
		CMPLG5430N_	665	686	54	30	2 3/8
		CMPLG5436N_	745	785	54	36	2 3/8
		CMPLG5442N_	828	869	54	42	2 3/8
		CMPLG5448N_	914	955	54	48	2 3/8
		CMPLG5454N_	1010	1051	54	54	2 3/8
		CMPLG5460N_	1095	1136	54	60	2 3/8
	Non-Powered Compile 12" Top Glazed Single Segmented Panel Package - 66"	CMPLG6624N_	632	673	66	24	2 3/8
		CMPLG6630N_	726	767	66	30	2 3/8
		CMPLG6636N_	831	912	66	36	2 3/8
		CMPLG6642N_	907	988	66	42	2 3/8
		CMPLG6648N_	1004	1084	66	48	2 3/8
		CMPLG6654N_	1106	1187	66	54	2 3/8
		CMPLG6660N_	1203	1284	66	60	2 3/8

**Raceway Cover Options (1) Shown**

- **RACEWAY COVER OPTIONS (Suffix)**
  - (0) No Knockouts Side 1 and Side 2
  - (1) Knockouts Side 1 – No Knockout Side 2
  - (2) Knockouts Side 1 and Side 2

**CMPLGXXYP\_ - SINGLE 12" GLAZED AT TOP PANEL – POWERED**

- Individual fabric-covered module in lower position with 12" H glazed module in upper position incorporated into an aluminum frame.
- Opposite sides of each module may have a different fabric within the same grade at no upcharge.
- If different grades of fabric are used on one panel, the entire panel must be priced at highest grade.
- Panels are not tackable.
- Note: Trim is not required at a straight connection between two panels of the same height.
- 3 Panel connector brackets per side come standard with 42"h, 48"h and 54"h panels.
- 4 Panel connector brackets per side come standard with 66"h panels.
- Standard clear (CLR) plexi.
- Optional Frosted Plexi with 10% upcharge.
- 24" wide panels have two punchouts, one for electrical and one for data.
- 30" wide panels and wider have three punchouts, two for electrical and one for data.
- Please specify duplex receptacles separately.
- Glazing is 12" nominal from the top of the panel.

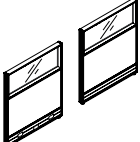
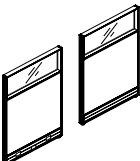
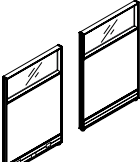
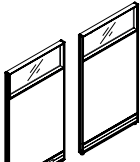
	DESCRIPTION	PRODUCT CODE	LIST PRICE		DIMENSIONS/INCHES		
			Gr1	Gr2	H	W	D
	Powered Compile 12" Top Glazed Single Segmented Panel Package - 42"	CMPLG4224P_	728	751	42	24	2 3/8
		CMPLG4230P_	880	903	42	30	2 3/8
		CMPLG4236P_	988	1028	42	36	2 3/8
		CMPLG4242P_	1078	1119	42	42	2 3/8
		CMPLG4248P_	1171	1212	42	48	2 3/8
		CMPLG4254P_	1278	1318	42	54	2 3/8
		CMPLG4260P_	1382	1422	42	60	2 3/8
	Powered Compile 12" Top Glazed Single Segmented Panel Package - 48"	CMPLG4824P_	741	764	48	24	2 3/8
		CMPLG4830P_	886	905	48	30	2 3/8
		CMPLG4836P_	975	1013	48	36	2 3/8
		CMPLG4842P_	1062	1098	48	42	2 3/8
		CMPLG4848P_	1149	1187	48	48	2 3/8
		CMPLG4854P_	1264	1302	48	54	2 3/8
		CMPLG4860P_	1354	1392	48	60	2 3/8
	Powered Compile 12" Top Glazed Single Segmented Panel Package - 54"	CMPLG5424P_	742	763	54	24	2 3/8
		CMPLG5430P_	888	909	54	30	2 3/8
		CMPLG5436P_	975	1016	54	36	2 3/8
		CMPLG5442P_	1062	1103	54	42	2 3/8
		CMPLG5448P_	1169	1210	54	48	2 3/8
		CMPLG5454P_	1264	1305	54	54	2 3/8
		CMPLG5460P_	1354	1395	54	60	2 3/8
	Powered Compile 12" Top Glazed Single Segmented Panel Package - 66"	CMPLG6624P_	798	838	66	24	2 3/8
		CMPLG6630P_	949	990	66	30	2 3/8
		CMPLG6636P_	1048	1128	66	36	2 3/8
		CMPLG6642P_	1144	1224	66	42	2 3/8
		CMPLG6648P_	1259	1340	66	48	2 3/8
		CMPLG6654P_	1363	1444	66	54	2 3/8
		CMPLG6660P_	1460	1540	66	60	2 3/8

**Raceway Cover Options (1) Shown**

- **RACEWAY COVER OPTIONS (Suffix)**
  - (1) Knockouts Side 1 – No Knockout Side 2
  - (2) Knockouts Side 1 and Side 2

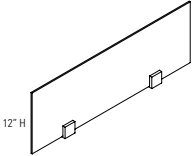
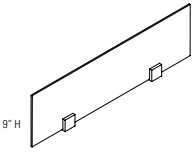
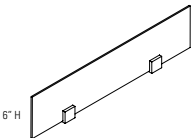

**CMPSXX - COMPILE PRIVACY GLASS**

- Attaches on top of Compile Panels to add privacy or divide space.
- Standard in clear (CLR) or frosted (FRST) glass.
- Clamps available in satin chrome finish only.
- Width dimensions given are width of glass only.
- Attachment hardware is provided for attaching to panels.
- Please note Privacy Glass in 24" - 54" widths includes 2 clamps and a Privacy Glass in 60" width includes 3 clamps.
- Square profile on clamps and glass corners.

	DESCRIPTION	PRODUCT CODE	LIST PRICE		DIMENSIONS/INCHES		
			CLR	FRST ADD	H	W	D
 <p>12" H</p>	Compile Privacy Glass	CMPS24	316	68	12	24	6
		CMPS30	335	50	12	30	6
		CMPS36	354	40	12	36	6
		CMPS42	365	61	12	42	6
		CMPS48	375	83	12	48	6
		CMPS54	386	100	12	54	6
		CMPS60	403	124	12	60	6
 <p>9" H</p>		CMPS0924	316	68	9	24	6
		CMPS0930	335	54	9	30	6
		CMPS0936	354	40	9	36	6
		CMPS0942	365	64	9	42	6
		CMPS0948	375	83	9	48	6
		CMPS0954	386	100	9	54	6
		CMPS0960	403	124	9	60	6
 <p>6" H</p>		CMPS0624	316	68	6	24	6
		CMPS0630	335	54	6	30	6
		CMPS0636	354	40	6	36	6
		CMPS0642	365	64	6	42	6
		CMPS0648	375	83	6	48	6
		CMPS0654	386	100	6	54	6
		CMPS0660	403	124	6	60	6

**CMPSGXX - COMPILE PRIVACY GLASS PANEL WIDTH**

- Attaches on top of Compile Panels to add privacy or divide space.
- Standard in clear (CLR) or frosted (FRST) glass.
- Width dimensions given are width of glass only.
- Attachment hardware is provided for attaching to panels.

	DESCRIPTION	PRODUCT CODE	LIST PRICE		DIMENSIONS/INCHES		
			CLR	FRST ADD	H	W	D
	Compile Privacy Glass	CMPSEG0624	283	62.26	6	24	2.41
		CMPSEG0630	309	48	6	30	2.41
		CMPSEG0636	328	32.8	6	36	2.41
		CMPSEG0642	342	56	6	42	2.41
		CMPSEG0648	363	72.6	6	48	2.41
		CMPSEG0654	377	93	6	54	2.41
		CMPSEG0660	386	120	6	60	2.41
		CMPSEG0924	283	62.26	9	24	2.41
		CMPSEG0930	309	48	9	30	2.41
		CMPSEG0936	328	32.8	9	36	2.41
		CMPSEG0942	342	56	9	42	2.41
		CMPSEG0948	363	72.6	9	48	2.41
		CMPSEG0954	377	93	9	54	2.41
		CMPSEG0960	386	120	9	60	2.41
		CMPSEG1224	283	62.26	12	24	2.41
		CMPSEG1230	309	48	12	30	2.41
		CMPSEG1236	328	32.8	12	36	2.41
		CMPSEG1242	342	56	12	42	2.41
		CMPSEG1248	363	72.6	12	48	2.41
		CMPSEG1254	377	93	12	54	2.41
		CMPSEG1260	386	120	12	60	2.41

**CMPMP-GI-W - PRIVACY GLASS FOR 1" LAMINATE GALLERY PANELS**

- Privacy glass integrated with aluminum top trim.
- Attaches on top of gallery panels to add privacy or divide space.
- Includes aluminum trim with channel, end caps and glass tile.
- Top rail may also be used to hang accessories.
- Glass and attachment hardware ship separately.
- Please specify standard paint finish for the channel.
- Standard in clear (CLR) or frosted (FRST).

	DESCRIPTION	PRODUCT CODE	LIST PRICE		DIMENSIONS/INCHES		
			Clear	FRST ADD	H	W	D
	6" H Privacy Glass w/ Aluminum Trim	CMPMP24GI6W	311	71	6	24	1
		CMPMP30GI6W	338	50	6	30	1
		CMPMP36GI6W	359	36	6	36	1
		CMPMP42GI6W	375	59	6	42	1
		CMPMP48GI6W	395	76	6	48	1
	9" H Privacy Glass w/ Aluminum Trim	CMPMP24GI9W	311	71	9	24	1
		CMPMP30GI9W	338	50	9	30	1
		CMPMP36GI9W	359	36	9	36	1
		CMPMP42GI9W	375	59	9	42	1
		CMPMP48GI9W	395	76	9	48	1
	12" H Privacy Glass w/ Aluminum Trim	CMPMP24GIW	311	66	12	24	1
		CMPMP30GIW	338	50	12	30	1
		CMPMP36GIW	359	36	12	36	1
		CMPMP42GIW	375	59	12	42	1
		CMPMP48GIW	395	76	12	48	1



**CMPFD-W - PRIVACY FELT FOR 1" LAMINATE GALLERY PANELS**

- Privacy felt integrated with aluminum top trim.
- Attaches on top of gallery panels to add privacy or divide space.
- Includes aluminum trim with channel, end caps and felt tile.
- Top rail may also be used to hang accessories.
- Felt and attachment hardware ship separately.
- Please specify standard paint finish for the channel.
- Please specify standard felt finish.

	DESCRIPTION	PRODUCT CODE	LIST PRICE	DIMENSIONS/INCHES		
				H	W	D
	6" H Felt w/ Aluminum Trim	CMPFD0624W	125	6	24	1
		CMPFD0630W	145	6	30	1
		CMPFD0636W	172	6	36	1
		CMPFD0642W	193	6	42	1
		CMPFD0648W	283	6	48	1
		CMPFD0654W	310	6	54	1
		CMPFD0660W	332	6	60	1
		CMPFD0666W	350	6	66	1
	9" H Felt w/ Aluminum Trim	CMPFD0924W	125	9	24	1
		CMPFD0930W	145	9	30	1
		CMPFD0936W	172	9	36	1
		CMPFD0942W	193	9	42	1
		CMPFD0948W	283	9	48	1
		CMPFD0954W	310	9	54	1
		CMPFD0960W	332	9	60	1
		CMPFD0966W	350	9	66	1
	12" H Felt w/ Aluminum Trim	CMPFD1224W	125	12	24	1
		CMPFD1230W	145	12	30	1
		CMPFD1236W	172	12	36	1
		CMPFD1242W	193	12	42	1
		CMPFD1248W	283	12	48	1
		CMPFD1254W	310	12	54	1
		CMPFD1260W	332	12	60	1
		CMPFD1266W	350	12	66	1
	CMPFD1272W	395	12	72	1	

**CMPSEF - EMBEDDED FELT DIVIDER OVER PANEL**

- Privacy felt panel intergrated with aluminum top trim.
- Attaches on top of panels to add privacy or divide space.
- Includes aluminum trim with channel and felt tile.
- Felt and attachment hardware to ship separately
- 9mm Felt material is tackable and comes in 12 different colors. Please specify color.

DESCRIPTION	PRODUCT CODE	LIST PRICE	DIMENSIONS/INCHES		
			H	W	D
 6" Integrated Felt Divider, Panel Width	CMPSEF0624	115	6	24	2.41
	CMPSEF0630	133	6	30	2.41
	CMPSEF0636	159	6	36	2.41
	CMPSEF0642	175	6	42	2.41
	CMPSEF0648	262	6	48	2.41
	CMPSEF0654	282	6	54	2.41
	CMPSEF0660	305	6	60	2.41
 9" Integrated Felt Divider, Panel Width	CMPSEF0924	115	9	24	2.41
	CMPSEF0930	133	9	30	2.41
	CMPSEF0936	159	9	36	2.41
	CMPSEF0942	175	9	42	2.41
	CMPSEF0948	262	9	48	2.41
	CMPSEF0954	282	9	54	2.41
	CMPSEF0960	305	9	60	2.41
 12" Integrated Felt Divider, Panel Width	CMPSEF1224	115	12	24	2.41
	CMPSEF1230	133	12	30	2.41
	CMPSEF1236	159	12	36	2.41
	CMPSEF1242	175	12	42	2.41
	CMPSEF1248	262	12	48	2.41
	CMPSEF1254	282	12	54	2.41
	CMPSEF1260	305	12	60	2.41

**CMOF - COMPILE FABRIC OVER PANEL**

- Fabric-covered modules incorporated into an aluminum frame.
- Opposite sides of each module may have a different fabric within the same grade at no upcharge.
- If different grades of fabric are used on one panel, the entire panel must be priced at highest grade.
- One CHSD Slider Kit for Over Panel included
- Note: Trim is not required at a straight connection between two panels of the same height.
- Maximum stacking one high. Not load bearing.

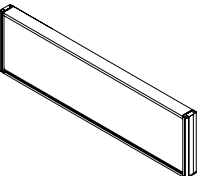
DESCRIPTION	PRODUCT CODE	LIST PRICE		DIMENSIONS/INCHES		
		Gr1	Gr2	H	W	D
 Compile Fabric Over Panel	CMOF1224	220	248	12	24	2.3
	CMOF1230	257	285	12	30	2.3
	CMOF1236	286	315	12	36	2.3
	CMOF1242	324	353	12	42	2.3
	CMOF1248	374	403	12	48	2.3
	CMOF1254	388	417	12	54	2.3
	CMOF1260	460	488	12	60	2.3
	CMOF1624	256	289	16	24	2.3
	CMOF1630	298	332	16	30	2.3
	CMOF1636	315	348	16	36	2.3
	CMOF1642	375	409	16	42	2.3
	CMOF1648	430	464	16	48	2.3
	CMOF1654	450	483	16	54	2.3
	CMOF1660	526	560	16	60	2.3
	CMOF2424	330	377	24	24	2.3
	CMOF2430	381	428	24	30	2.3
	CMOF2436	426	473	24	36	2.3
	CMOF2442	478	525	24	42	2.3
	CMOF2448	515	562	24	48	2.3
	CMOF2454	572	619	24	54	2.3
CMOF2460	657	704	24	60	2.3	

**CMOLF - COMPILE LAMINATE ONE SIDE, FABRIC ONE SIDE OVER PANEL**

- One side in fabric and one side in laminate, incorporated into an aluminum frame.
- Opposite sides of each module may have a different fabric within the same grade at no upcharge.
- If different grades of fabric are used on one panel, the entire panel must be priced at highest grade.
- One CHSD Slider Kit for Over Panel included
- Note: Trim is not required at a straight connection between two panels of the same height.
- Maximum stacking one high. Not load bearing.

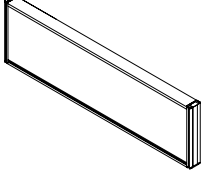
DESCRIPTION	PRODUCT CODE	LIST PRICE		DIMENSIONS/INCHES		
		Gr1	Gr2	H	W	D
 <p>Compile Laminate One Side, Fabric One Side Over Panel</p>	CMOLF1224	246	264	12	24	2.3
	CMOLF1230	289	307	12	30	2.3
	CMOLF1236	328	343	12	36	2.3
	CMOLF1242	372	387	12	42	2.3
	CMOLF1248	427	442	12	48	2.3
	CMOLF1254	451	466	12	54	2.3
	CMOLF1260	527	542	12	60	2.3
	CMOLF1624	294	314	16	24	2.3
	CMOLF1630	351	371	16	30	2.3
	CMOLF1636	388	408	16	36	2.3
	CMOLF1642	440	460	16	42	2.3
	CMOLF1648	502	522	16	48	2.3
	CMOLF1654	530	550	16	54	2.3
	CMOLF1660	617	637	16	60	2.3
	CMOLF2424	385	411	24	24	2.3
	CMOLF2430	460	484	24	30	2.3
	CMOLF2436	510	534	24	36	2.3
	CMOLF2442	573	599	24	42	2.3
CMOLF2448	623	649	24	48	2.3	
CMOLF2454	695	719	24	54	2.3	
CMOLF2460	794	818	24	60	2.3	

**CMOLL - COMPILE LAMINATE TWO SIDES OVER PANEL**

- Laminate modules incorporated into an aluminum frame.
- One CHSD Slider Kit for Over Panel included
- Note: Trim is not required at a straight connection between two panels of the same height.
- Maximum stacking one high. Not load bearing.

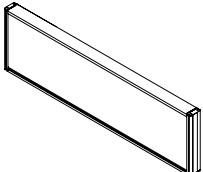
DESCRIPTION	PRODUCT CODE	LIST PRICE	DIMENSIONS/INCHES		
			H	W	D
 <p>Compile Laminate Two Sides Over Panel</p>	CMOLL1224	273	12	24	2.3
	CMOLL1230	310	12	30	2.3
	CMOLL1236	365	12	36	2.3
	CMOLL1242	416	12	42	2.3
	CMOLL1248	478	12	48	2.3
	CMOLL1254	507	12	54	2.3
	CMOLL1260	589	12	60	2.3
	CMOLL1624	327	16	24	2.3
	CMOLL1630	385	16	30	2.3
	CMOLL1636	438	16	36	2.3
	CMOLL1642	498	16	42	2.3
	CMOLL1648	570	16	48	2.3
	CMOLL1654	606	16	54	2.3
	CMOLL1660	699	16	60	2.3
	CMOLL2424	435	24	24	2.3
	CMOLL2430	513	24	30	2.3
	CMOLL2436	585	24	36	2.3
	CMOLL2442	663	24	42	2.3
CMOLL2448	724	24	48	2.3	
CMOLL2454	806	24	54	2.3	
CMOLL2460	917	24	60	2.3	

**CMOG - COMPILE GLAZED OVER PANEL**

- Glazed module incorporated into an aluminum frame.
- One CHSD Slider Kit for Over Panel included
- Note: Trim is not required at a straight connection between two panels of the same height.
- Maximum stacking one high. Not load bearing.

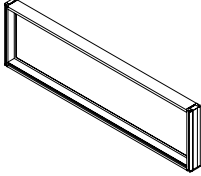
DESCRIPTION	PRODUCT CODE	LIST PRICE		DIMENSIONS/INCHES		
		CLR	FRST ADD	H	W	D
 <p>Compile Glazed Over Panel</p>	CMOG1224	196	10	12	24	2.3
	CMOG1230	228	10	12	30	2.3
	CMOG1236	255	11	12	36	2.3
	CMOG1242	285	11	12	42	2.3
	CMOG1248	327	12	12	48	2.3
	CMOG1254	340	14	12	54	2.3
	CMOG1260	407	15	12	60	2.3
	CMOG1624	228	10	16	24	2.3
	CMOG1630	258	11	16	30	2.3
	CMOG1636	294	12	16	36	2.3
	CMOG1642	328	12	16	42	2.3
	CMOG1648	377	14	16	48	2.3
	CMOG1654	389	15	16	54	2.3
	CMOG1660	460	18	16	60	2.3
	CMOG2424	292	12	24	24	2.3
	CMOG2430	315	12	24	30	2.3
	CMOG2436	371	14	24	36	2.3
	CMOG2442	416	15	24	42	2.3
	CMOG2448	443	18	24	48	2.3
	CMOG2454	491	19	24	54	2.3
	CMOG2460	569	19	24	60	2.3

**CMOFW - COMPILE ONE SIDE WRITE BOARD OVER PANEL**

- Fabric or write board covered modules incorporated into an aluminum frame.
- One CHSD Slider Kit for Over Panel included
- Note: Trim is not required at a straight connection between two panels of the same height.
- Maximum stacking one high. Not load bearing.

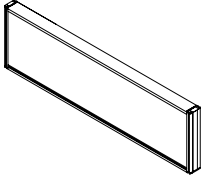
DESCRIPTION	PRODUCT CODE	LIST PRICE		DIMENSIONS/INCHES		
		Gr1	Gr2	H	W	D
 <p>Compile Fabric or Write Board Over Panel</p>	CMOFW1224	277	292	12	24	2.3
	CMOFW1230	328	343	12	30	2.3
	CMOFW1236	372	387	12	36	2.3
	CMOFW1242	423	438	12	42	2.3
	CMOFW1248	468	483	12	48	2.3
	CMOFW1254	516	531	12	54	2.3
	CMOFW1260	601	616	12	60	2.3
	CMOFW1624	333	353	16	24	2.3
	CMOFW1630	392	412	16	30	2.3
	CMOFW1636	448	467	16	36	2.3
	CMOFW1642	510	529	16	42	2.3
	CMOFW1648	583	603	16	48	2.3
	CMOFW1654	621	640	16	54	2.3
	CMOFW1660	714	733	16	60	2.3
	CMOFW2424	430	456	24	24	2.3
	CMOFW2430	495	519	24	30	2.3
	CMOFW2436	606	630	24	36	2.3
	CMOFW2442	678	704	24	42	2.3
	CMOFW2448	713	737	24	48	2.3
	CMOFW2454	852	876	24	54	2.3
	CMOFW2460	946	970	24	60	2.3

**CMOWW - COMPILE WRITE BOARD TWO SIDES OVER PANEL**

- Write board covered modules incorporated into an aluminum frame.
- One CHSD Slider Kit for Over Panel included
- Note: Trim is not required at a straight connection between two panels of the same height.
- Maximum stacking one high. Not load bearing.

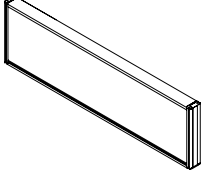
DESCRIPTION	PRODUCT CODE	LIST PRICE	DIMENSIONS/INCHES		
			H	W	D
 <p>Compile Write Board Over Panel</p>	CMOWW1224	336	12	24	2.3
	CMOWW1230	389	12	30	2.3
	CMOWW1236	463	12	36	2.3
	CMOWW1242	516	12	42	2.3
	CMOWW1248	606	12	48	2.3
	CMOWW1254	638	12	54	2.3
	CMOWW1260	738	12	60	2.3
	CMOWW1624	411	16	24	2.3
	CMOWW1630	492	16	30	2.3
	CMOWW1636	568	16	36	2.3
	CMOWW1642	650	16	42	2.3
	CMOWW1648	740	16	48	2.3
	CMOWW1654	800	16	54	2.3
	CMOWW1660	913	16	60	2.3
	CMOWW2424	562	24	24	2.3
	CMOWW2430	671	24	30	2.3
	CMOWW2436	776	24	36	2.3
	CMOWW2442	888	24	42	2.3
	CMOWW2448	982	24	48	2.3
	CMOWW2454	1095	24	54	2.3
CMOWW2460	1241	24	60	2.3	

**CHSD - SLIDER KIT FOR OVER PANEL**

- One kit required for installation of each Over Panel
- Included with each NEW Over Panel Kit

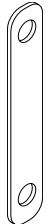
DESCRIPTION	PRODUCT CODE	LIST PRICE	DIMENSIONS/INCHES		
			H	W	D
 <p>One kit required for installation of each Over Panel</p>	CHSDKIT	7	.09	2.28	.43

**CMLEPXXXXNC - END OF RUN GALLERY PANEL WITH NO END CONNECTION**

- Provides floor standing support while enclosing the end of a panel run.
- Attached at the end of a straight panel run with connectors to form a T configuration.
- No connections at both ends, connection is at the center interior face.
- Includes all attachment hardware and glides.
- Total height is inclusive of panel glides extended to their full height.
- 51" wide gallery panel accommodates two 24" deep surface while the 63" wide accommodates two 30" deep surfaces.
- Please specify LP laminate finish and PVC edge finish.
- If a wood grain laminate is chosen, grain direction run horizontally.
- Gallery panel is edged in PVC on exposed edges and self edged on bottom.

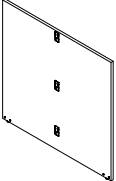
DESCRIPTION	PRODUCT CODE	LIST PRICE	DIMENSIONS/INCHES		
			H	W	D
 End of Run Gallery Panel	CMLEP4227NC	466	42	26.25	1
	CMLEP4251NC	845	42	50.30	1
	CMLEP4263NC	982	42	62.30	1
	CMLEP4827NC	513	48	26.25	1
	CMLEP4851NC	928	48	50.30	1
	CMLEP4863NC	1078	48	62.30	1
	CMLEP5427NC	559	54	26.25	1
	CMLEP5451NC	1012	54	50.30	1
	CMLEP5463NC	1176	54	62.30	1

**CMLMPXXXXNC - MIDDLE OF RUN GALLERY PANEL WITH NO END CONNECTION**

- Provides floor standing support in the middle of a panel run.
- Attached in the middle of a straight panel run with connectors to form an X configuration.
- No connections at both ends, connection is at center on both faces.
- Includes all attachment hardware and glides.
- Total height is inclusive of panel glides extended to their full height.
- 51" wide gallery panel accommodates two 24" deep surface while the 63" wide accommodates two 30" deep surfaces.
- Please specify LP laminate finish and PVC edge finish.
- If a wood grain laminate is chosen, grain direction run horizontally.
- Gallery panel is edged in PVC on exposed edges and self edged on bottom.

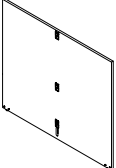
DESCRIPTION	PRODUCT CODE	LIST PRICE	DIMENSIONS/INCHES		
			H	W	D
 Middle of Run Gallery Panel	CMLMP4251NC	983	42	50.30	1
	CMLMP4263NC	1118	42	62.30	1
	CMLMP4851NC	1066	48	50.30	1
	CMLMP4863NC	1216	48	62.30	1
	CMLMP5451NC	1150	54	50.30	1
	CMLMP5463NC	1314	54	62.30	1

**CMLSEPLXXXNC - SINGLE END OF RUN GALLERY PANEL WITH NO END CONNECTION**

- Provides floor standing support while enclosing the end of a panel run.
- Attached at the end of a straight panel run with connectors to form an L configuration.
- No connections at both ends, connection is at center on both faces.
- Includes all attachment hardware and glides.
- Total height is inclusive of panel glides extended to their full height.
- 27" wide gallery panel accommodate two 24" deep surface while the 33" wide accommodates two 30" deep surfaces.
- Please specify LP laminate finish and PVC edge finish.
- If a wood grain laminate is chosen, grain direction run horizontally.
- Gallery panel is edged in PVC on exposed edges and self edged on bottom.

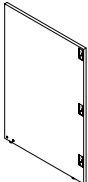
	DESCRIPTION	PRODUCT CODE	LIST PRICE	DIMENSIONS/INCHES		
				H	W	D
	Single End of Run Gallery Panel	CMLSEPL4215NC	350	42	14.25	1
		CMLSEPR4215NC	350	42	14.25	1
		CMLSEPL4227NC	644	42	26.30	1
		CMLSEPR4227NC	644	42	26.30	1
		CMLSEPL4815NC	381	48	14.25	1
		CMLSEPR4815NC	381	48	14.25	1
		CMLSEPL4827NC	703	48	26.30	1
		CMLSEPR4827NC	703	48	26.30	1
		CMLSEPL5415NC	410	54	14.25	1
		CMLSEPR5415NC	410	54	14.25	1
		CMLSEPL5427NC	763	54	26.30	1
CMLSEPR5427NC	763	54	26.30	1		
		CMLSEPL4233NC	664	42	32.33	1
		CMLSEPR4233NC	664	42	32.33	1
		CMLSEPL4833NC	725	48	32.33	1
		CMLSEPR4833NC	725	48	32.33	1
		CMLSEPL5433NC	786	54	32.33	1
		CMLSEPR5433NC	786	54	32.33	1

**CMLSMPXXXNC - SINGLE MIDDLE OF RUN GALLERY PANEL WITH NO END CONNECTION**

- Provides floor standing support at the middle of a panel run.
- Attached in the middle of a straight panel run with connectors to form a T configuration.
- No connections at the exposed end, connection is at both the interior and exterior face near the opposite end.
- Includes all attachment hardware and glides.
- Total height is inclusive of panel glides extended to their full height.
- 27" wide gallery panel accommodates a 24" deep surface while the 33" wide accommodates a 30" deep surface.
- Please specify LP laminate finish and PVC edge finish.
- If a wood grain laminate is chosen, grain direction run horizontally.
- Gallery panel is edged in PVC on exposed edges and self edged on bottom.

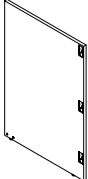
	DESCRIPTION	PRODUCT CODE	LIST PRICE	DIMENSIONS/INCHES		
				H	W	D
	Single Middle of Run Gallery Panel	CMLSMP4227NC	782	42	26.30	1
		CMLSMP4827NC	842	48	26.30	1
		CMLSMP5427NC	901	54	26.30	1
		CMLSMP4233NC	805	42	32.30	1
		CMLSMP4833NC	865	48	32.30	1
		CMLSMP5433NC	927	54	32.30	1

**CMLEPXXXX - END OF RUN GALLERY PANEL WITH END CONNECTIONS**

- Provides floor standing support while enclosing the end of a panel run.
- Attached at the end of a straight panel run with connectors to form a T configuration.
- Connections at both ends as well as the center on the interior face.
- Includes all attachment hardware and glides.
- Total height is inclusive of panel glides extended to their full height.
- 51" wide gallery panel accommodates two 24" deep surface while the 63" wide accommodates two 30" deep surfaces.
- Please specify LP laminate finish and PVC edge finish.
- If a wood grain laminate is chosen, grain direction run horizontally.
- Gallery panel is edged in PVC on exposed edges and self edged on edge connecting to panel and bottom edge.

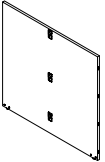
DESCRIPTION	PRODUCT CODE	LIST PRICE	DIMENSIONS/INCHES		
			H	W	D
 End of Run Gallery Panel	CMLEP4251	879	42	50.30	1
	CMLEP4263	1013	42	62.30	1
	CMLEP4851	961	48	50.30	1
	CMLEP4863	1111	48	62.30	1
	CMLEP5451	1045	54	50.30	1
	CMLEP5463	1210	54	62.30	1

**CMLMPXXXX - MIDDLE OF RUN GALLERY PANEL WITH END CONNECTIONS**

- Provides floor standing support in the middle of a panel run.
- Attached in the middle of a straight panel run with connectors to form an X configuration.
- Connections at both ends as well as the center on the interior face.
- Includes all attachment hardware and glides.
- Total height is inclusive of panel glides extended to their full height.
- 51" wide gallery panel accommodates two 24" deep surface while the 63" wide accommodates two 30" deep surfaces.
- Please specify LP laminate finish and PVC edge finish.
- If a wood grain laminate is chosen, grain direction run horizontally.
- Gallery panel is edged in PVC on exposed edges and self edged on edge connecting to panel and bottom edge.

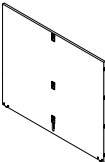
DESCRIPTION	PRODUCT CODE	LIST PRICE	DIMENSIONS/INCHES		
			H	W	D
 Middle of Run Gallery Panel	CMLMP4251	988	42	50.30	1
	CMLMP4263	1123	42	62.30	1
	CMLMP4851	1072	48	50.30	1
	CMLMP4863	1221	48	62.30	1
	CMLMP5451	1154	54	50.30	1
	CMLMP5463	1322	54	62.30	1

**CMLSEPLXXXX - SINGLE END PANEL WITH END CONNECTIONS**

- Provides floor standing support while enclosing the end of a panel run.
- Attached at the end of a straight panel run with connectors to form an L configuration.
- Connections are at the exposed end on one side and near the end on the other interior face.
- Total height is inclusive of panel glides extended to their full height.
- 27" wide gallery panel accommodates a 24" deep surface while the 33" wide accommodates a 30" deep surface.
- Please specify LP laminate finish and PVC edge finish.
- If a wood grain laminate is chosen, grain direction run horizontally.
- Gallery panel is edged in PVC on exposed edges and self edged on edge connecting to panel and bottom edge.

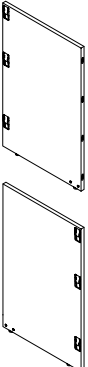
DESCRIPTION	PRODUCT CODE	LIST PRICE	DIMENSIONS/INCHES		
			H	W	D
 Single End of Run Gallery Panel	CMLSEPL4227	659	42	26.30	1
	CMLSEPR4227	659	42	26.30	1
	CMLSEPL4827	721	48	26.30	1
	CMLSEPR4827	721	48	26.30	1
	CMLSEPL5427	779	54	26.30	1
	CMLSEPR5427	779	54	26.30	1
	CMLSEPL4233	680	42	32.33	1
	CMLSEPR4233	680	42	32.33	1
	CMLSEPL4833	740	48	32.33	1
	CMLSEPR4833	740	48	32.33	1
	CMLSEPL5433	803	54	32.33	1
	CMLSEPR5433	803	54	32.33	1

**CMLSMPXXXX - SINGLE MIDDLE OF RUN GALLERY PANEL WITH END CONNECTIONS**

- Provides floor standing support at the middle of a panel run.
- Attached in the middle of a straight panel run with connectors to form a T configuration
- Connections are at the exposed end and at the interior and exterior near the opposite end.
- Includes all attachment hardware and glides.
- Total height is inclusive of panel glides extended to their full height.
- 27" wide gallery panel accommodates a 24" deep surface while the 33" wide accommodates a 30" deep surface.
- Please specify LP laminate finish and PVC edge finish.
- If a wood grain laminate is chosen, grain direction run horizontally.
- Gallery panel is edged in PVC on exposed edges and self edged on edge connecting to panel and bottom edge.

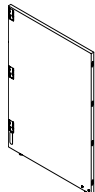
	DESCRIPTION	PRODUCT CODE	LIST PRICE	DIMENSIONS/INCHES		
				H	W	D
	Single Middle of Run Gallery Panel	CMLSMP4227	797	42	26.30	1
		CMLSMP4827	858	48	26.30	1
		CMLSMP5427	915	54	26.30	1
		CMLSMP4233	821	42	32.30	1
		CMLSMP4833	882	48	32.30	1
		CMLSMP5433	944	54	32.30	1

**CML2PLXXXX - LEFT TWO WAY RETURN END OF RUN GALLERY PANEL WITH END CONNECTIONS**

- Provides floor standing support while enclosing the end of a panel run.
- Attached at the end of a gallery panel with connectors to form an L configuration.
- Connections are at one exposed end.
- Includes all attachment hardware and glides.
- Total height is inclusive of panel glides extended to their full height.
- 25" wide gallery panel accommodates a 24" deep surface while the 31" wide accommodates a 30" deep surface.
- Please specify LP laminate finish and PVC edge finish.
- If a wood grain laminate is chosen, grain direction run horizontally.
- Gallery panel is edged in PVC on exposed edges and self edged on edge connecting to panel and bottom edge.

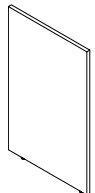
	DESCRIPTION	PRODUCT CODE	LIST PRICE	DIMENSIONS/INCHES		
				H	W	D
	Two Way Return	CML2PL4213	240	42	13	1
	End of Run Gallery Panel	CML2PL4225	523	42	25	1
		CML2PL4231	537	42	31	1
		CML2PL4813	269	48	13	1
		CML2PL4825	582	48	25	1
		CML2PL4831	598	48	31	1
		CML2PL5413	299	54	13	1
		CML2PL5425	640	54	25	1
		CML2PL5431	659	54	31	1

**CML2PRXXXX - RIGHT TWO WAY RETURN END OF RUN GALLERY PANEL WITH END CONNECTIONS**

- Provides floor standing support while enclosing the end of a panel run.
- Attached at the end of a gallery panel with connectors to form an L configuration.
- Connections are at one exposed end.
- Includes all attachment hardware and glides.
- Total height is inclusive of panel glides extended to their full height.
- 25" wide gallery panel accommodates a 24" deep surface while the 31" wide accommodates a 30" deep surface.
- Please specify LP laminate finish and PVC edge finish.
- If a wood grain laminate is chosen, grain direction run horizontally.
- Gallery panel is edged in PVC on exposed edges and self edged on edge connecting to panel and bottom edge.

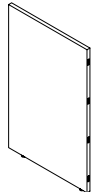
	DESCRIPTION	PRODUCT CODE	LIST PRICE	DIMENSIONS/INCHES		
				H	W	D
	Two Way Return	CML2PR4213	240	42	13	1
	End of Run Gallery Panel	CML2PR4225	523	42	25	1
		CML2PR4231	537	42	31	1
		CML2PR4813	269	48	13	1
		CML2PR4825	582	48	25	1
		CML2PR4831	598	48	31	1
		CML2PR5413	299	54	13	1
		CML2PR5425	640	54	25	1
		CML2PR5431	659	54	31	1

**CML3PLXXXX - LEFT THREE WAY RETURN END OF RUN GALLERY PANEL**

- Provides floor standing support while enclosing the end of a gallery panel run.
- Attached at the end of a gallery panel with connectors to form a T configuration.
- There are no connections at the exposed ends. Connection is at the center of the interior face.
- Connects to CMLXPLxxxx or CMLSEPLxxxx.
- Includes all attachment hardware and glides.
- Total height is inclusive of panel glides extended to their full height.
- 49" wide gallery panel accommodates two 24" deep surface while the 61" wide accommodates two 30" deep surfaces.
- Please specify LP laminate finish and PVC edge finish.
- If a wood grain laminate is chosen, grain direction run horizontally.
- Gallery panel is edged in PVC on exposed edges and self edged on edge connecting to panel and bottom edge.

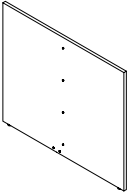
DESCRIPTION	PRODUCT CODE	LIST PRICE	DIMENSIONS/INCHES		
			H	W	D
 <p>Three Way Return End of Run Gallery Panel</p>	CML3PL4225	357	42	25	1
	CML3PL4249	724	42	49	1
	CML3PL4261	859	42	61	1
	CML3PL4825	401	48	25	1
	CML3PL4849	807	48	49	1
	CML3PL4861	957	48	61	1
	CML3PL5425	447	54	25	1
	CML3PL5449	889	54	49	1
	CML3PL5461	1054	54	61	1

**CML3PRXXXX - RIGHT THREE WAY RETURN END OF RUN GALLERY PANEL**

- Provides floor standing support while enclosing the end of a gallery panel run.
- Attached at the end of a gallery panel with connectors to form a T configuration.
- There are no connections at the exposed ends. Connection is at the center of the interior face.
- Connects to CMLXPRxxxx or CMLSEPRxxxx.
- Includes all attachment hardware and glides.
- Total height is inclusive of panel glides extended to their full height.
- 49" wide gallery panel accommodates two 24" deep surface while the 61" wide accommodates two 30" deep surfaces.
- Please specify LP laminate finish and PVC edge finish.
- If a wood grain laminate is chosen, grain direction run horizontally.
- Gallery panel is edged in PVC on exposed edges and self edged on edge connecting to panel and bottom edge.

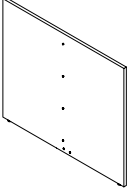
DESCRIPTION	PRODUCT CODE	LIST PRICE	DIMENSIONS/INCHES		
			H	W	D
 <p>Three Way Return End of Run Gallery Pane</p>	CML3PR4225	357	42	25	1
	CML3PR4249	724	42	49	1
	CML3PR4261	859	42	61	1
	CML3PR4825	401	48	25	1
	CML3PR4849	807	48	49	1
	CML3PR4861	957	48	61	1
	CML3PR5425	447	54	25	1
	CML3PR5449	889	54	49	1
	CML3PR5461	1054	54	61	1

**CMLXPLXXXX - LEFT EXTENSION END OF RUN RETURN GALLERY PANEL WITH END CONNECTION**

- Provides floor standing support while enclosing the end of a gallery panel run.
- Attached at the end of a panel to allow for extending the gallery panel run.
- Connections at both exposed ends, one to connect to the panel and one to connect to another gallery panel.
- Includes all attachment hardware and glides.
- Total height is inclusive of panel glides extended to their full height.
- Please specify LP laminate finish and PVC edge finish.
- If a wood grain laminate is chosen, grain direction run horizontally.
- Gallery panel is edged in PVC on exposed edged and self edges on edge connecting to panel.

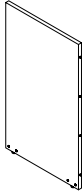
DESCRIPTION	PRODUCT CODE	LIST PRICE	DIMENSIONS/INCHES		
			H	W	D
 Extension End of Run Return Gallery Panel	CMLXPL4224	846	42	12.3	1
	CMLXPL4224	846	42	24	1
	CMLXPL4230	509	42	30	1
	CMLXPL4236	586	42	35	1
	CMLXPL4242	736	42	42	1
	CMLXPL4248	756	42	48	1
	CMLXPL4812	248	48	12.3	1
	CMLXPL4824	448	48	24	1
	CMLXPL4830	526	48	30	1
	CMLXPL4836	601	48	36	1
	CMLXPL4842	756	48	42	1
	CMLXPL4848	779	48	48	1
	CMLXPL5412	277	54	12.3	1
	CMLXPL5424	478	54	24	1
	CMLXPL5430	560	54	30	1
	CMLXPL5436	644	54	36	1
	CMLXPL5442	726	54	42	1
	CMLXPL5448	892	54	48	1

**CMLXPRXXXX - RIGHT EXTENSION END OF RUN RETURN GALLERY PANEL WITH END CONNECTION**

- Provides floor standing support while enclosing the end of a gallery panel run.
- Attached at the end of a panel to allow for extending the gallery panel run.
- Connections at both exposed ends, one to connect to the panel and one to connect to another gallery panel.
- Includes all attachment hardware and glides.
- Total height is inclusive of panel glides extended to their full height.
- Please specify LP laminate finish and PVC edge finish.
- If a wood grain laminate is chosen, grain direction run horizontally.
- Gallery panel is edged in PVC on exposed edged and self edges on edge connecting to panel.

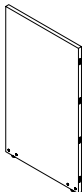
DESCRIPTION	PRODUCT CODE	LIST PRICE	DIMENSIONS/INCHES		
			H	W	D
 Extension End of Run Return Gallery Panel	CMLXPL4212	222	42	12.3	1
	CMLXPR4224	846	42	24	1
	CMLXPR4230	509	42	30	1
	CMLXPR4236	586	42	35	1
	CMLXPR4242	736	42	42	1
	CMLXPR4248	756	42	48	1
	CMLXPL4812	248	48	12.3	1
	CMLXPR4824	448	48	24	1
	CMLXPR4830	526	48	30	1
	CMLXPR4836	601	48	36	1
	CMLXPR4842	756	48	42	1
	CMLXPR4848	779	48	48	1
	CMLXPL5412	277	54	12.3	1
	CMLXPR5424	478	54	24	1
	CMLXPR5430	560	54	30	1
	CMLXPR5436	644	54	36	1
	CMLXPR5442	726	54	42	1
	CMLXPR5448	892	54	48	1

**CMLXPLXXXNC - EXTENSION END OF RUN, LEFT, NO CONNECTION**

- Provides floor standing support while enclosing the end of a gallery panel run.
- Attached at the end of a gallery panel to extend the gallery panel run.
- Connections only at one exposed end.
- Includes all attachment hardware and glides.
- Total height is inclusive of panel glides extended to their full height.
- Please specify LP laminate finish and PVC edge finish.
- If a wood grain laminate is chosen, grain direction run horizontally.
- Gallery panel is edged in PVC on exposed edges and self edged on edge connecting to panel.

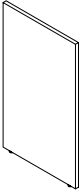
	DESCRIPTION	PRODUCT CODE	LIST PRICE	DIMENSIONS/INCHES		
				H	W	D
	Extension End of Run Gallery Panel	CMLXPL4224NC	432	42	24	1
		CMLXPL4230NC	506	42	30	1
		CMLXPL4236NC	582	42	35	1
		CMLXPL4242NC	732	42	42	1
		CMLXPL4248NC	753	42	48	1
		CMLXPL4824NC	445	48	24	1
		CMLXPL4830NC	523	48	30	1
		CMLXPL4836NC	598	48	36	1
		CMLXPL4842NC	753	48	42	1
		CMLXPL4848NC	776	48	48	1
		CMLXPL5424NC	476	54	24	1
		CMLXPL5430NC	558	54	30	1
		CMLXPL5436NC	640	54	36	1
		CMLXPL5442NC	724	54	42	1
		CMLXPL5448NC	889	54	48	1

**CMLXPLXXXNC • EXTENSION END OF RUN, RIGHT, NO CONNECTION**

- Provides floor standing support while enclosing the end of a gallery panel run.
- Attached at the end of a gallery panel to extend the gallery panel run.
- Connections only at one exposed end.
- Includes all attachment hardware and glides.
- Total height is inclusive of panel glides extended to their full height.
- Please specify LP laminate finish and PVC edge finish.
- If a wood grain laminate is chosen, grain direction run horizontally.
- Gallery panel is edged in PVC on exposed edges and self edged on edge connecting to panel.

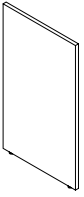
	DESCRIPTION	PRODUCT CODE	LIST PRICE	DIMENSIONS/INCHES		
				H	W	D
	Extension End of Run Gallery Panel	CMLXPR4224NC	432	42	24	1
		CMLXPR4230NC	506	42	30	1
		CMLXPR4236NC	582	42	35	1
		CMLXPR4242NC	732	42	42	1
		CMLXPR4248NC	753	42	48	1
		CMLXPR4824NC	445	48	24	1
		CMLXPR4830NC	523	48	30	1
		CMLXPR4836NC	598	48	36	1
		CMLXPR4842NC	753	48	42	1
		CMLXPR4848NC	776	48	48	1
		CMLXPR5424NC	476	54	24	1
		CMLXPR5430NC	558	54	30	1
		CMLXPR5436NC	640	54	36	1
		CMLXPR5442NC	724	54	42	1
		CMLXPR5448NC	889	54	48	1

**CMHLPBB01 - GALLERY PANEL BRACKET**

- Gallery panel bottom bracket connects two gallery end panels at bottom with screws.
- Available in standard paint colors.
- Screws are included with the bracket.

	DESCRIPTION	PRODUCT CODE	LIST PRICE	DIMENSIONS/INCHES		
				H	W	D

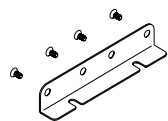

Bracket	CMHLPBB01	50	1.5	8	1
---------	-----------	----	-----	---	---

**CMHLPCB01 - GALLERY PANEL CORNER BRACKET**

- Gallery panel corner bottom bracket connects two laminate panels at 90 degrees.
- Screws are included with the bracket.
- Available in standard paint colors.

DESCRIPTION	PRODUCT CODE	LIST PRICE	DIMENSIONS/INCHES		
			H	W	D
 <p>Corner Bracket</p>	CMHLPCB01	48	1.5	4	4

**CMPDPS - SLIDING DOOR**

- Sliding Door provides privacy in an open plan environment.
- Complete Sliding Door kit includes aluminum door panel, rails, and capture extrusion.
- Door is non-handed (Can be assembled to slide left or right).
- 36" wide door spans 36" opening. Sliding Door rails must be installed on adjacent 42" panel.
- 42" wide door spans 42" opening. Privacy screen rails must be installed on adjacent 48" panel.
- Available in Clear (CLR) or Frosted (FRST) acrylic glazing.
- Available in all Panel Frame Finishes.
- Metal Finish - standard panel frame finishes.
- Lockable - key option - key alike, W series or random

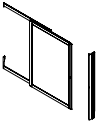
DESCRIPTION	PRODUCT CODE	LIST PRICE	DIMENSIONS/INCHES		
			H	W	D
 <p>Sliding Door</p>	CMPDPS6636	2981	66	43	3
	CMPDPS6642	3126	66	49	3

**CMPDPSF - SLIDING DOOR**

- Sliding Door provides privacy in an open plan environment.
- Complete Sliding Door kit includes aluminum door panel, rails, and capture extrusion.
- Door is non-handed (Can be assembled to slide left or right).
- 36" wide door spans 36" opening. Sliding Door rails must be installed on adjacent 42" panel.
- 42" wide door spans 42" opening. Privacy screen rails must be installed on adjacent 48" panel.
- Available in standard felt finishes.
- Available in all Panel Frame Finishes.
- Metal Finish - standard panel frame finishes.
- Lockable - key option - key alike, W series or random

DESCRIPTION	PRODUCT CODE	LIST PRICE	DIMENSIONS/INCHES		
			H	W	D
 <p>Felt Sliding Door</p>	CMPDPSF6636	2159	66	43	3
	CMPDPSF6642	2265	66	49	3



**CMFMA - MINI PANEL KIT**

- The Compile mini panel is an excellent sales tool featuring two panel and samples of various hardware and electrical components and consists of the following:
  - One Monolithic Mini Panel (Laminate side one / Acoustic side two).
  - One Segmented Glazed Mini panel.
  - One 2-way Universal Corner Post Kit.
  - Two 24" Raceway Cover with Punch Out.
  - Two 24" Raceway Cover with out Punch Out.
  - One Raceway Cut Out Cover.
  - One 3-way Post Base Cover.
  - One End of Run Trim.
  - One Pair of Corner Brackets.
  - One Mid span Worksurface Support Bracket.
  - One Duplex.
  - One Power Distribution Harness.
  - One Mesh jumper.
  - One Carry Bag.

DESCRIPTION	PRODUCT CODE	LIST PRICE	DIMENSIONS/INCHES		
			H	W	D
 <p>Mini Panel Kit</p>	CMFMA2418KIT1	2605	30	24	2 7/8

**CHP POST PACKAGE**

- Universal Post with all "Quick-Connection" clips.
- Post trim(s)
- Post base and top cap

	DESCRIPTION	PRODUCT CODE	LIST PRICE	DIMENSIONS/INCHES		
				H	W	D
	2 - Way Post	CHP30-2	124	30	2.3	2.3
		CHP42-2	124	42	2.3	2.3
		CHP46-2	179	46	2.3	2.3
		CHP48-2	146	48	2.3	2.3
		CHP54-2	152	54	2.3	2.3
		CHP58-2	224	58	2.3	2.3
		CHP60-2	224	60	2.3	2.3
		CHP64-2	265	64	2.3	2.3
		CHP66-2	179	66	2.3	2.3
		CHP70-2	258	70	2.3	2.3
		CHP72-2	258	72	2.3	2.3
		CHP78-2	294	78	2.3	2.3
		CHP82-2	309	82	2.3	2.3
		CHP90-2	309	90	2.3	2.3
	3 - Way Post	CHP30-3	109	30	2.3	2.3
		CHP42-3	109	42	2.3	2.3
		CHP46-3	162	46	2.3	2.3
		CHP48-3	162	48	2.3	2.3
		CHP54-3	135	54	2.3	2.3
		CHP58-3	203	58	2.3	2.3
		CHP60-3	203	60	2.3	2.3
		CHP64-3	216	64	2.3	2.3
		CHP66-3	162	66	2.3	2.3
		CHP70-3	233	70	2.3	2.3
		CHP72-3	233	72	2.3	2.3
		CHP78-3	265	78	2.3	2.3
		CHP82-3	277	82	2.3	2.3
		CHP90-3	307	90	2.3	2.3
	4 - Way Post	CHP30-4	88	30	2.3	2.3
	*No trim or base. Includes top cap only.	CHP42-4	88	42	2.3	2.3
		CHP46-4	148	46	2.3	2.3
		CHP48-4	109	48	2.3	2.3
		CHP54-4	114	54	2.3	2.3
		CHP58-4	165	58	2.3	2.3
		CHP60-4	165	60	2.3	2.3
		CHP64-4	175	64	2.3	2.3
		CHP66-4	135	66	2.3	2.3
		CHP70-4	193	70	2.3	2.3
		CHP72-4	193	72	2.3	2.3
		CHP78-4	219	78	2.3	2.3
		CHP82-4	228	82	2.3	2.3
		CHP90-4	255	90	2.3	2.3



**CHPXW - 90 DEGREE CORNER POST KIT FOR OVER PANELS**

- Specify the corner post height that matches the height of the over panel
- 2-way kits include 2 trims (CMETPxx), 2 way post base (CMPCxx) and post cap (CMPC).
- 3-way kits include 2 trim (CMETPxx), 3 way post base (CMPCxx) and post cap (CMPC).
- 4-way kits include post cap (CMPC) only.

	DESCRIPTION	PRODUCT CODE	LIST PRICE	DIMENSIONS/INCHES			
				H	W	D	
	90 Degree Corner Post Kit for Over Panels	CHOP12-2	81	12	2.3	2.3	
		CHOP12-3	69	12	2.3	2.3	
		CHOP12-4	48	12	2.3	2.3	
			CHOP16-2	81	16	2.3	2.3
			CHOP16-3	81	16	2.3	2.3
			CHOP16-4	69	16	2.3	2.3
			CHOP24-2	90	24	2.3	2.3
			CHOP24-3	81	24	2.3	2.3
			CHOP24-4	68	24	2.3	2.3

**CHPXW - 60 DEGREE POST PACKAGE**

- Universal Post with all "Quick-Connection" clips.
- Post trim is incorporated into 2 - Way aluminum post extrusion.
- Post top cap
- Outer part of the post is the full panel height and the inner part of the post is 6" shorter.
- 3 - Way post is 6" shorter than panel height to accommodate electric and base.
- PVC post trims can not be added to 60 degree posts.

	DESCRIPTION	PRODUCT CODE	LIST PRICE	DIMENSIONS/INCHES		
				H	W	D
	2 - Way - 60 Degree Post Package	CHP2W30	88	30	2.3	2.3
		CHP2W42	88	42	2.3	2.3
		CHP2W46	114	46	2.3	2.3
		CHP2W54	114	54	2.3	2.3
		CHP2W58	156	58	2.3	2.3
		CHP2W60	171	60	2.3	2.3
		CHP2W64	185	64	2.3	2.3
		CHP2W66	135	66	2.3	2.3
		CHP2W70	196	70	2.3	2.3
		CHP2W72	196	72	2.3	2.3
		CHP2W78	219	78	2.3	2.3
		CHP2W82	228	82	2.3	2.3
		CHP2W90	251	90	2.3	2.3
			3 - Way - 60 Degree Post Package	CHP3W30	88	30
CHP3W42	88			42	2.3	2.3
CHP3W46	125			46	2.3	2.3
CHP3W54	114			54	2.3	2.3
CHP3W58	156			58	2.3	2.3
CHP3W60	171			60	2.3	2.3
CHP3W64	185			64	2.3	2.3
CHP3W66	135			66	2.3	2.3
CHP3W70	196			70	2.3	2.3
CHP3W72	196			72	2.3	2.3
CHP3W78	219			78	2.3	2.3
CHP3W82	228			82	2.3	2.3
CHP3W90	251			90	2.3	2.3

**CMRCXXNP - COMPILE RACEWAY COVER - WITHOUT KNOCKOUTS**

- No electrical knockouts included.
- Note: Made of reinforced aluminum.

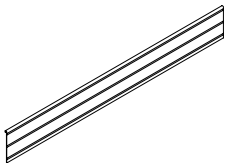
	DESCRIPTION	PRODUCT CODE	LIST PRICE	DIMENSIONS/INCHES		
				H	W	D
	Compile Raceway Cover Without Knockouts	CMRC24NP	20	24		
		CMRC30NP	24	30		
		CMRC36NP	27	36		
		CMRC42NP	29	42		
		CMRC48NP	33	48		
		CMRC54NP	40	54		
		CMRC60NP	42	60		

**CMRCXXPO - COMPILE RACEWAY COVER - WITH KNOCKOUTS**

- Contains one knockout for 24" w and three knockouts for 30" w+.
- Raceway Knockout Cover must be added to openings where duplex receptacles are not used.
- Note: Made of reinforced aluminum.

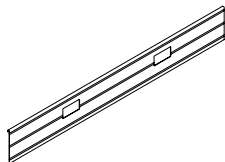
	DESCRIPTION	PRODUCT CODE	LIST PRICE	DIMENSIONS/INCHES		
				H	W	D
	Compile Raceway Cover With Knockouts	CMRC24PO	20	24		
		CMRC30PO	24	30		
		CMRC36PO	27	36		
		CMRC42PO	29	42		
		CMRC48PO	33	48		
		CMRC54PO	40	54		
		CMRC60PO	42	60		

**CMRCB01 - COMPILE RACEWAY KNOCKOUT COVER**

- Fills knockout when duplex is not used.
- Available in Black, White, Nevada, and Fog.
- Note: Knockout covers are made of plastic.

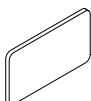
	DESCRIPTION	PRODUCT CODE	LIST PRICE	DIMENSIONS/INCHES		
				H	W	D
	Compile Raceway Knockout Cover	CMRCB01	19			

**CHP - 90-DEGREE UNIVERSAL CORNER POST**

- Available in 42", 54" and 66"h.
- Standard Compile paint options.
- Specify the corner post height that matches the tallest or smallest panel connection.
- Can be used for any variation of 90-degree connections: 2-way, 3-way or 4-way.
- Requires post trim inserts to finish off post where there are no panel connections. Post trim inserts are specified separately.
- 6" shorter than panel height to accommodate electric in base.
- Requires a post basecover to finish off post at the base (for 2- or 3-way). Refer to CMPC.
- See Panel Configuration Tips for application.
- Made of aluminum.

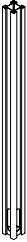
	DESCRIPTION	PRODUCT CODE	LIST PRICE	DIMENSIONS/INCHES		
				H	W	D
	90-Degree Universal Corner Post	CHP30	82	30		
		CHP42	82	36		
		CHP54	106	48		
		CHP66	130	60		

**CMET - END OF RUN TRIM INSERT FOR PANEL**

- Trim inserts are not included with panels.
- Cannot be used for a universal post application.
- Used at the end of each panel run and cannot be used to attach a panel run to a fixed wall.
- Vertical trims must be specified separately. Trim snaps in the panel at the end of run.
- Standard Compile paint options.
- See Panel Configuration Tips for application.
- Trims are PVC.

	DESCRIPTION	PRODUCT CODE	LIST PRICE	DIMENSIONS/INCHES		
				H	W	D
	End of Run Trim Insert for Panel	CMET16	20	16	2.3	0.5
		CMET30	23	30	2.3	0.5
		CMET42	23	42	2.3	0.5
		CMET46	24	46	2.3	0.5
		CMET48	27	48	2.3	0.5
		CMET54	27	54	2.3	0.5
		CMET58	28	58	2.3	0.5
		CMET60	28	60	2.3	0.5
		CMET64	29	64	2.3	0.5
		CMET66	29	66	2.3	0.5
		CMET70	32	70	2.3	0.5
		CMET72	32	72	2.3	0.5
		CMET78	34	78	2.3	0.5
		CMET82	35	82	2.3	0.5
		CMET90	41	90	2.3	0.5

**CMETP - TRIM INSERT FOR UNIVERSAL CORNER POST**

- Does not come with a post.
- Trim installs on all exposed sides of a Universal Corner Post.
- Specify to equal post height.
- Trims must be specified separately. Trim snaps in the post.
- Available in standard Compile paint options.
- 6" shorter than Universal Corner Post to accommodate Post Base Cover (must be specified separate)
- See Panel Configuration Tips for application.

DESCRIPTION	PRODUCT CODE	LIST PRICE	DIMENSIONS/INCHES			
			H	W	D	
	Trim Insert for Universal Corner Post	CMETP30	19	30	2.3	0.5
		CMETP42	19	42	2.3	0.5
		CMETP46	24	46	2.3	0.5
		CMETP48	15	48	2.3	0.5
		CMETP54	20	54	2.3	0.5
		CMETP58	26	58	2.3	0.5
		CMETP60	28	60	2.3	0.5
		CMETP64	29	64	2.3	0.5
		CMETP66	21	66	2.3	0.5
		CMETP70	33	70	2.3	0.5
		CMETP72	33	72	2.3	0.5
		CMETP78	34	78	2.3	0.5
		CMETP82	36	82	2.3	0.5
		CMETP90	41	90	2.3	0.5

**CMET - TRIM INSERT FOR STEP DOWN**

- Does not come with a post. Trim inserts are not included with Universal Corner Posts.
- Specify to meet the taller post.
- Trim snaps in the post or end of run at a change in height.
- Available in standard Compile paint options.
- Can not be applied to 60 degree posts.
- See Panel Configuration Tips for application.

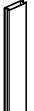
DESCRIPTION	PRODUCT CODE	LIST PRICE	DIMENSIONS/INCHES		
			H	W	D
	Trim Insert for Step Down	CMET06	12	6	
		CMET12	15	12	
		CMET18	20	18	
		CMET24	26	24	
		CMET36	32	36	

**CHWAXX - WALL ADAPTER**

- Same profile as vertical extrusion.
- Wall attachment hardware not provided.
- Made of aluminum.

DESCRIPTION	PRODUCT CODE	LIST PRICE	DIMENSIONS/INCHES			
			H	W	D	
	Wall Adapter	CHWA30	51	30	2.36	.79
		CHWA42	69	42	2.36	.79
		CHWA46	69	46	2.36	.79
		CHWA48	69	48	2.36	.79
		CHWA54	87	54	2.36	.79
		CHWA58	87	58	2.36	.79
		CHWA60	101	60	2.36	.79
		CHWA64	101	64	2.36	
		CHWA66	101	66	2.36	.79
		CHWA70	116	70	2.36	.79
		CHWA72	116	72	2.36	.79
		CHWA78	130	78	2.36	.79
		CHWA82	146	82	2.36	.79
		CHWA90	160	90	2.36	.79

**CWMA - VERTICAL CHANNEL**

- Used to attach system components to fixed wall.
- Panel frame finish.
- Comes in 60" length only.
- Care should be taken to mount adapters only to wall studs using correct fasteners.
- Does not include mounting hardware. Mounting hardware selection to be based on wall material.
- Failure to do this may result in collapse of the unit and subsequent possible personal injury.
- Compile vertical channels cannot be shared.

	DESCRIPTION	PRODUCT CODE	LIST PRICE	DIMENSIONS/INCHES		
				H	W	D
	Vertical Channel Sold in pairs	CWMA60	42	60	0.6	0.7

**CMPC - UNIVERSAL POST CAP**

- Comes standard with universal post.
- Specified separately for reconfiguration purposes.
- Available in standard Compile paint options.
- Made of PVC.

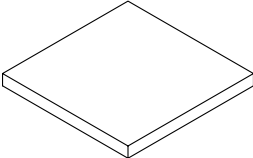
	DESCRIPTION	PRODUCT CODE	LIST PRICE	DIMENSIONS/INCHES		
				H	W	D
	Universal Post Cap	CMPC	9	2 3/8		

**CMPC - POST BASE COVER**

- Post Base Covers are not included with Universal Corner Posts.
- Base trim for universal post. These are connected with screws at the base and the trims at the post will slide to meet.
- Available for 2-way and 3-way configurations.
- Finish is smooth plastic.
- Available in standard Compile paint options.

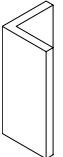
	DESCRIPTION	PRODUCT CODE	LIST PRICE	DIMENSIONS/INCHES		
				H	W	D
	Post Base Cover - 3-Way Connection	CMPC1	14	6		
	Post Base Cover - 2-Way Connection	CMPC2	15	6		

**CMHLPF - FLAT LEG FOR FREESTANDING PANELS**

- Not intended to add to a run of panels in conjunction with Leveling Glides. panel and replace it with the legs.
- Kit will contains one legs and all attachment hardware. • Please specify paint finish.
- For the installation the customer will have to remove the existing levelers on the

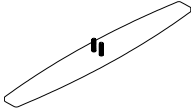
	DESCRIPTION	PRODUCT CODE	LIST PRICE	DIMENSIONS/INCHES		
				H	W	D
	Single Flat Leg	CMHLPF01	135	.31	21	3

**CMHLPF - FLAT LEG FOR FREESTANDING PANELS**

- Double kit for freestanding applications. • Please specify paint finish.
- Kit will contains two legs and all attachment hardware. • Note: Leg is on available for freestanding panels 42" to 60" wide.
- For the installation the customer will have to remove the existing levelers on the panel and replace it with the legs.

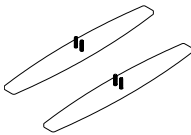
	DESCRIPTION	PRODUCT CODE	LIST PRICE	DIMENSIONS/INCHES		
				H	W	D
	Double Flat Leg	CMHLPF02	267	.31	21	3

**CMHLLP01 - LOW PROFILE FOOT**

- Provides added support to a panel under load. • Made of powder coated steel.
- Adjustable glides and connectors included.

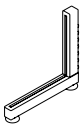
	DESCRIPTION	PRODUCT CODE	LIST PRICE	DIMENSIONS/INCHES		
				H	W	D
	Low Profile Foot	CMHLLP01	200	12	11	1.1

**CMHLLP02 - LOW PROFILE FOOT**

- Provides added support to a panel under load. • Made of powder coated steel.
- Adjustable glides and connectors included. • Set includes 2 complete legs.

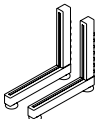
	DESCRIPTION	PRODUCT CODE	LIST PRICE	DIMENSIONS/INCHES		
				H	W	D
	Double Low Profile Foot	CMHLLP02	397	12	11	1.1

**CMPS - POST SEPARATOR**

- Creates a diagonal division within a compile post.
- Please specify post height.

DESCRIPTION	PRODUCT CODE	LIST PRICE	DIMENSIONS/INCHES		
			H	W	D



Post Separator

CMPS01

165

96

3.25

14

