

storage

## LATERAL FILE FEATURES

### DRAWERS/SHELVES

- Drawer interlocking system
- Three-stage, anti-bounceback suspension
- Pre-installed, side-to-side file bars for letter, legal and A4
- Front-to-back file bars – optional
- Full-height dividers – optional
- Angled full pull

### CONSTRUCTION

- Top stiffener bar
- Corner gussets
- Four (4) ganging drill points are marked to ensure correct positioning
- Cam lock included
- Leveling glides
- Counterweights are included in 2, 3 and 4 drawer cabinets. BIFMA does not require counterweight in 5 drawer cabinets.

## PEDESTAL FEATURES

### DRAWERS/SHELVES

- All drawer fronts feature a recessed, angled full pull.
- Drawers feature ball bearing suspension.

### CONSTRUCTION

- Central Core removable cam locks.
- Pedestals are 15" wide.
- Counterweight is standard on all Freestanding models.
- Worksurfaces supporting models have holes drilled in top to attach underneath a worksurface.

## STANDARD PAINT COLORS

BLACK	BLK
DESIGNER WHITE	DWT
NEVADA	NEV
STEEL	STL

## TEXTURED PAINT COLORS

Only available on Compile Storage.

BLIZZARD	BZD
STONE DUST	SDT

## GENERAL WARRANTY INFORMATION

- Evolve warrants all components of metal storage and filing for the lifetime of the product to the original purchaser.



This page provides a three dimensional view of a sample configuration highlighting each storage component required when specifying this configuration.

## Components

- A. CSOF13XX KD Overhead
- B. CSSL13XX Low-Profile Shelf
- C. CM19XXBBF Worksurface Supporting Box, Box, File Pedestal

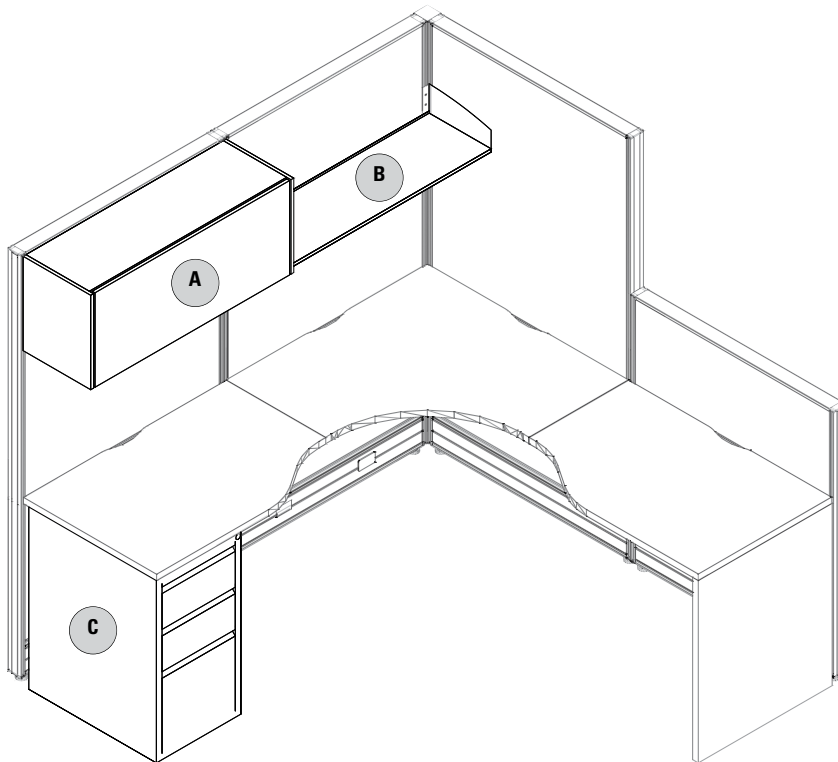

# STORAGE

## CS19XXBBF - WORKSURFACE SUPPORTING BOX/BOX/FILE 15" PEDESTAL

- Worksurface supporting, with predrilled holes in the top.
- Also available as freestanding with finished top.
- All drawer fronts feature a recessed, angled full pull.
- Pedestal height shown includes glide.
- Pencil tray and Lock included.
- File Bars are not included with Compile pedestals. To order file bars, use product code CSPEDHFB at \$29.00 each list.

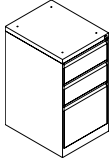
	DESCRIPTION	PRODUCT CODE	LIST PRICE	DIMENSIONS/INCHES		
				H	D	W
	Worksurface Supporting Box/Box/File 15" Pedestal	CS1919BBF	549	27 5/8	18 5/8	15
		CS1923BBF	565	27 5/8	22 5/8	15
		CS1929BBF	641	27 5/8	29 5/8	15

## CS19XXFF - WORKSURFACE SUPPORTING FILE/FILE 15" PEDESTAL

- Worksurface supporting, with predrilled holes in the top.
- Also available as freestanding with finished top.
- All drawer fronts feature a recessed, angled full pull.
- Pedestal height shown includes glide.
- Lock included.
- File Bars are not included with Compile pedestals. To order file bars, use product code CSPEDHFB at \$29.00 each list.

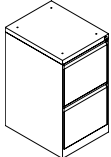
	DESCRIPTION	PRODUCT CODE	LIST PRICE	DIMENSIONS/INCHES		
				H	D	W
	Worksurface Supporting File/File 15" Pedestal	CS1919FF	549	27 5/8	18 5/8	15
		CS1923FF	565	27 5/8	22 5/8	15
		CS1929FF	641	27 5/8	29 5/8	15

## CS19FXBBF - FREESTANDING BOX/BOX/FILE 15" PEDESTAL

- All drawer fronts feature a recessed, angled full pull.
- Pedestal height shown includes glide.
- Finished top.
- Counterweight, Pencil tray and Lock included.
- File Bars are not included with Compile pedestals. To order file bars, use product code CSPEDHFB at \$29.00 each list.

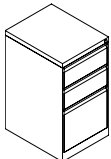
	DESCRIPTION	PRODUCT CODE	LIST PRICE	DIMENSIONS/INCHES		
				H	D	W
	Freestanding Box/Box/File 15" Pedestal	CS19F19BBF	565	27 5/8	18 5/8	15
		CS19F23BBF	582	27 5/8	22 5/8	15
		CS19F29BBF	655	27 5/8	29 5/8	15

## CS19FXFF - FREESTANDING FILE/FILE 15" PEDESTAL

- All drawer fronts feature a recessed, angled full pull.
- Pedestal height shown includes glide.
- Finished top.
- Counterweight and Lock included.
- File Bars are not included with Compile pedestals. To order file bars, use product code CSPEDHFB at \$29.00 each list.

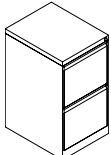
	DESCRIPTION	PRODUCT CODE	LIST PRICE	DIMENSIONS/INCHES		
				H	D	W
	Freestanding File/File 15" Pedestal	CS19F19FF	565	27 5/8	18 5/8	15
		CS19F23FF	582	27 5/8	22 5/8	15
		CS19F29FF	655	27 5/8	29 5/8	15



# STORAGE

## CS19MPXXBBF - MOBILE BOX/BOX/FILE PEDESTAL

- All drawer fronts feature a recessed, angled full pull.
- Pedestal height shown includes glide.
- Finished top.
- Counterweight, Pencil tray, and Lock included.
- File Bars are not included with Compile pedestals. To order file bars, use product code CSPEDHFB at \$29.00 each list.

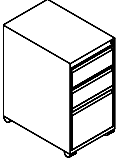
	DESCRIPTION	PRODUCT CODE	LIST PRICE	DIMENSIONS/INCHES		
				H	D	W
	Mobile Box/Box/File Pedestal	CS19MP19BBF	748	27 7/8	18 5/8	15
		CS19MP23BBF	787	27 7/8	22 5/8	15

## CS19MPXXFF - MOBILE FILE/FILE PEDESTAL

- All drawer fronts feature a recessed, angled full pull.
- Pedestal height shown includes glide.
- Finished top.
- Counterweight and Lock included.
- File Bars are not included with Compile pedestals. To order file bars, use product code CSPEDHFB at \$29.00 each list.

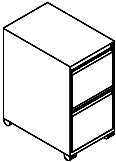
	DESCRIPTION	PRODUCT CODE	LIST PRICE	DIMENSIONS/INCHES		
				H	D	W
	Mobile File/File Pedestal	CS19MP19FF	748	27 7/8	18 5/8	15
		CS19MP23FF	787	27 7/8	22 5/8	15

## CSMCPXXBFNC - MOBILE BOX/FILE PEDESTAL WITH 60MM CASTERS

- Mobile pedestal that includes one pencil tray.
- Includes factory installed counterweight.
- Lock is standard.
- 60mm high casters.
- For use with pedestal seat cushion. See model below.
- Casters do not lock.

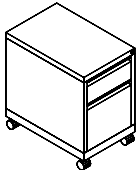
	DESCRIPTION	PRODUCT CODE	LIST PRICE	DIMENSIONS/INCHES		
				H	D	W
	Mobile Box/File Pedestal with 60mm Castors	CSMCP19BFNC	813	23.7/8	18.5/8	15
		CSMCP23BFNC	829	23.7/8	22.5/8	15

# STORAGE

## CSCUSH15 - PEDESTAL SEAT CUSHIONS

- Cushions will have single stitching at the seams.
- Velcro included for quick attachment to pedestal file.
- 1" Cushion will have a rectilinear design on all sides.
- 2" Cushion will have waterfall edges Front and Back,
- Cushions are for use on CSMCPXXBFNC Mobile Pedestals.
- Please choose a fabric from the standard cushion textiles on pages 94-96

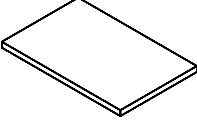
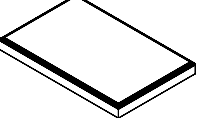
	DESCRIPTION	PRODUCT CODE	LIST PRICE/GRADES														DIM./INCH			YRDS			
			1	2	3	4	5	6	7	8	9	10	11	12	13	14	15	16	17		H	D	W
	Pedestal Seat	CSCUSH15X18-5/8X1	205	238	263	297	348	370	415	489	544	606	733	870	968	1102	1367	1633	1901	1	18.625	15	1
	Cushions - 1" Thick	CSCUSH15X22-5/8X1	229	262	287	321	372	394	439	513	568	630	757	894	989	1122	1389	1655	1924	1	22.625	15	1
	Pedestal Seat	CSCUSH15X18-5/8X2	227	259	283	318	370	392	437	509	565	627	752	892	1246	1423	1777	2131	2490	2	18.625	15	2
	Cushions - 2" Thick	CSCUSH15X22-5/8X2	255	288	317	363	426	456	515	608	678	758	923	1097	1271	1449	1802	2158	2514	2	22.625	15	2

## CSSL13 - LOW PROFILE SHELF

- 13" deep panel-mounted storage shelf with backlip.
- Mounting brackets are included.

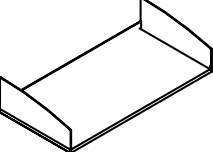
	DESCRIPTION	PRODUCT CODE	LIST PRICE	DIMENSIONS/INCHES		
				H	D	W
	Low Profile Shelf - 13"	CSSL1324	136	5	13	24
		CSSL1330	150	5	13	30
		CSSL1336	163	5	13	36
		CSSL1342	175	5	13	42
		CSSL1348	184	5	13	48
		CSSL1354	192	5	13	54
		CSSL1360	198	5	13	60

## CSOF13 - KD OVERHEAD

- Mounting brackets are included.
- Door retracts up and over the cabinet.
- Ready for quick assembly on site.
- Quality steel construction.
- 60" unit is reinforced for proper weight distribution.
- Inside dimensions: 12" h x 12.75" d

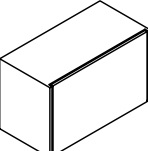
	DESCRIPTION	PRODUCT CODE	LIST PRICE	DIMENSIONS/INCHES		
				H	D	W
	KD Overhead - 13"	CSOF1324	357	14.5	13	24
		CSOF1330	392	14.5	13	30
		CSOF1336	432	14.5	13	36
		CSOF1342	457	14.5	13	42
		CSOF1348	483	14.5	13	48
		CSOF1354	547	14.5	13	54
		CSOF1360	591	14.5	13	60

## CMSLK13 - LOCK FOR KD OVERHEAD

- Must be specified separately.

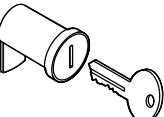
	DESCRIPTION	PRODUCT CODE	LIST PRICE	DIMENSIONS/INCHES		
				H	D	W
	Lock for KD Overhead	CMSLK13	44			



# STORAGE

## CSLOCKKEY - CORE AND KEY

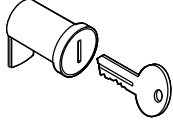
	DESCRIPTION	PRODUCT CODE	LIST PRICE	DIMENSIONS/INCHES		
				H	D	W
	LOCKKEY - Core and Key	CSLOCKKEY	42			

## CMEK93 - EXTRA KEY

- Must be specified at time of order.

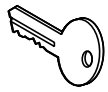
	DESCRIPTION	PRODUCT CODE	LIST PRICE	DIMENSIONS/INCHES		
				H	D	W
	Extra Key	CMEK93	19			

## CMDAOHXX - CENTER MOUNT OVERHEAD

- Inside dimensions 13" high x 13" deep.
- Laminate Overhead. No doors.
- Available in standard Compile laminate finishes.
- Top mount on panels.
- Overhead Support Brackets are included.

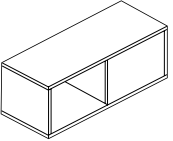
	DESCRIPTION	PRODUCT CODE	LIST PRICE	DIMENSIONS/INCHES		
				H	D	W
	Center Mount Overhead - 13"	CMDAOH36	1121	15	13	36
		CMDAOH42	1216	15	13	42
		CMDAOH48	1273	15	13	48
		CMDAOH54	1369	15	13	54
		CMDAOH60	1423	15	13	60

## CMADAXPM - ADA COMPLIANT OVERHEAD STORAGE UNIT

- Panel Mounted Overhead Storage with metal sides and opaque door that retracts on top of the unit
- Meets CSA B651 Barrier Free Design & ADA (American Disabilities Act).
- 16" high units accept standard and A4 binders.
- All shelves are reinforced for proper weight distribution.
- Inside dimensions: 14.25" high x 12" deep.
- Unit includes attachment hardware, lock and mounting brackets. Back not included.
- Shipped partially assembled.
- Available in standard Compile paint colors only. Door made of opaque plastic. \*\*add 10% upcharge for Fog.

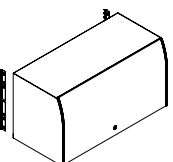
	DESCRIPTION	PRODUCT CODE	LIST PRICE	DIMENSIONS/INCHES		
				H	D	W
	ADA Compliant Overhead Storage Unit	CMADA30PM	1139	16	14.2	30
		CMADA36PM	1230	16	14.2	36
		CMADA42PM	1314	16	14.2	42
		CMADA48PM	1403	16	14.2	48
		CMADA54PM	1490	16	14.2	54
		CMADA60PM	1423	16	14.2	60

# STORAGE

## CWMA - VERTICAL CHANNEL

- Used to attach system components to fixed wall.
- Panel frame finish.
- Comes in 60" length only.
- Care should be taken to mount adapters only to wall studs using correct fasteners.
- Does not include mounting hardware. Mounting hardware selection to be based on wall material.
- Failure to do this may result in collapse of the unit and subsequent possible personal injury.
- Compile vertical channels cannot be shared.

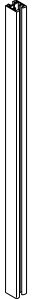
	DESCRIPTION	PRODUCT CODE	LIST PRICE	DIMENSIONS/INCHES		
				H	W	D
	Vertical Channel Sold in pairs	CWMA60	39	60	0.6	0.7

## CS19XX-1X1FH - ONE 1/2 HEIGHT FIXED FRONT & ONE 12" FIXED FRONT LATERAL FILE

- 1/2 Height Box Drawer.
- 1 Fixed Drawer Front.
- Includes Lock.
- Lateral File Top is required when not installed under a worksurface.
- Counterweights must be specified on lateral files with pull out drawers, unless worksurface supporting, ganged together or anchored to the floor or wall.

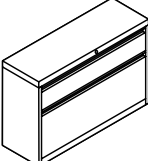
	DESCRIPTION	PRODUCT CODE	LIST PRICE	DIMENSIONS/INCHES		
				H	D	W
	One 1/2 Height Fixed Front &	CS1930P-1X1FH	1241	21.1875	19.25	30
	One 12" Fixed Front Lateral File	CS1936P-1X1FH	1325	21.1875	19.25	36
		CS1942P-1X1FH	1407	21.1875	19.25	42

## CS19XX-1XSND - ONE 1/2 HEIGHT OPEN SHELF & ONE 12" OPEN SHELF LATERAL CABINET

- 1/2 Height Open Shelf.
- Bottom Open Shelf.

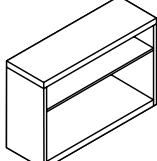
	DESCRIPTION	PRODUCT CODE	LIST PRICE	DIMENSIONS/INCHES		
				H	D	W
	One 1/2 Height Open Shelf &	CS1930-1XSND	622	21.1875	19.25	30
	One 12" Open Shelf Lateral Cabinet	CS1936-1XSND	707	21.1875	19.25	36
		CS1942-1XSND	787	21.1875	19.25	42





# STORAGE

## CSCUSH19 - LATERAL SEAT CUSHIONS

- Cushions will have single stitching at the seams,
- Velcro included for quick attachment to lateral file.
- 1" Cushion will have a rectilinear design on all sides.
- 2" Cushion will have waterfall edges Front and Back.
- Please choose a fabric from the standard cushion textiles on pages 244-246.

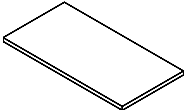
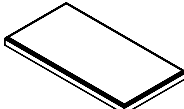
	DESCRIPTION	PRODUCT CODE	LIST PRICE/GRADES														DIM./INCH			YRDS			
			1	2	3	4	5	6	7	8	9	10	11	12	13	14	15	16	17		H	D	W
	Lateral Seat	CSCUSH19-25X30X1	374	416	448	494	564	595	658	755	830	914	1086	1268	1417	1597	1951	2306	2661	1	19	30	1
	Cushions - 1" Thick	CSCUSH19-25X36X1	388	430	462	510	578	609	672	769	844	928	1100	1281	1428	1606	1962	2317	2675	1	19	36	1
		CSCUSH19-25X42X1	402	443	476	522	591	622	684	780	856	941	1112	1295	1369	1547	1902	2257	2613	1	19	42	1
	Lateral Seat	CSCUSH19-25X30X2	415	457	489	535	605	636	697	793	869	954	1125	1308	1380	1558	1914	2268	2626	2	19	30	2
	Cushions - 2" Thick	CSCUSH19-25X36X2	426	468	500	546	615	647	708	804	880	965	1136	1319	1391	1568	1924	2277	2634	2	19	36	2
		CSCUSH19-25X42X2	442	484	516	564	632	663	724	823	896	981	1152	1335	1401	1580	1933	2290	2645	2	18	42	2

## CWFT - LATERAL FILE TOPS

- Available in standard Compile finishes.

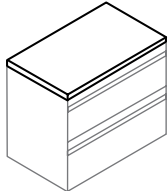
	DESCRIPTION	PRODUCT CODE	LIST PRICE	DIMENSIONS/INCHES		
			LP	H	D	W
	Lateral File Tops	CWFT1930	163	1	19.25	30
		CWFT1936	167	1	19.25	36
		CWFT1942	214	1	19.25	42
	2 Lateral Files SBS Top	CWFT1960	339	1	19.25	60
		CWFT1972	367	1	19.25	72
		CWFT1984	597	1	19.25	84
	4 Lateral File BTB Top	CWFT3860	673	1	38.75	60
		CWFT3872	765	1	38.75	72
		CWFT3884	907	1	38.75	84

## CS19XXP - 2F12 - LATERAL FILES - 2 DRAWERS WITH COUNTERWEIGHT

- Counterweight is standard. Two fixed front drawers.
- Side-to-side hanging file bars included.
- Drawers are 12.25" high.
- File cannot be used to store standard three ring binders.
- Lock included.

	DESCRIPTION	PRODUCT CODE	LIST PRICE	DIMENSIONS/INCHES		
				H	D	W
	Lateral Files - 2 Drawers	CS1930P-2F12	985	27.14	19.25	30
	with Counterweight	CS1936P-2F12	1061	27.14	19.25	36
		CS1942P-2F12	1103	27.14	19.25	42

# STORAGE

## CS19XXP - 3F12 - LATERAL FILES - 3 DRAWERS WITH COUNTERWEIGHT

- Counterweight is standard. Three fixed front drawers.
- Side-to-side hanging file bars included.
- Drawers are 12.25" high.
- File cannot be used to store standard three ring binders.
- Lock included.

	DESCRIPTION	PRODUCT CODE	LIST PRICE	DIMENSIONS/INCHES		
				H	D	W
	Lateral Files - 3 Drawers with Counterweight	CS1930P-3F12	1226	39.52	19.25	30
		CS1936P-3F12	1292	39.52	19.25	36
		CS1942P-3F12	1349	39.52	19.25	42

## CS19XXP - 4F12 - LATERAL FILES - 4 DRAWERS WITH COUNTERWEIGHT

- Counterweight is standard. Four fixed front drawers.
- Side-to-side hanging file bars included.
- Drawers are 12.25" high.
- File cannot be used to store standard three ring binders.
- Posting shelf option NOT available.
- Lock included.

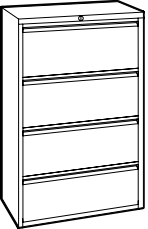
	DESCRIPTION	PRODUCT CODE	LIST PRICE	DIMENSIONS/INCHES		
				H	D	W
	Lateral Files - 4 Drawers with Counterweight	CS1930P-4F12	1565	51.89	19.25	30
		CS1936P-4F12	1639	51.89	19.25	36
		CS1942P-4F12	1764	51.89	19.25	42

## CS19XXP - 5F12 - LATERAL FILES - 5 DRAWERS

- Four fixed front drawers plus top drawer with receding door and roll-out shelf.
- Side-to-side hanging file bars included.
- Drawers are 12.25" high.
- File cannot be used to store standard three ring binders.
- Posting shelf option NOT available.
- Lock included.

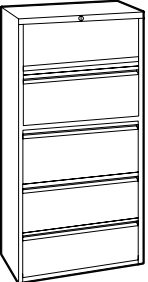
	DESCRIPTION	PRODUCT CODE	LIST PRICE	DIMENSIONS/INCHES		
				H	D	W
	Lateral Files - 5 Drawers	CS1930P-5F12	1863	66.39	19.25	30
		CS1936P-5F12	1945	66.39	19.25	36
		CS1942P-5F12	2052	66.39	19.25	42



# STORAGE

## CSPT - STORAGE TOWERS

- Model CSPT3-2BFL has wardrobe section on the left and drawers on the right. compartment, 2 box drawers and 1 file drawer. Locker compartment has one fixed shelf.
- Model CSPT3-2BFR has wardrobe section on the right and drawers on the left.
- Includes ventilated 24" D wardrobe section (ventilated on bottom of cabinet), locker • Locking.

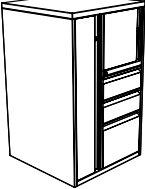
	DESCRIPTION	PRODUCT CODE	LIST PRICE	DIMENSIONS/INCHES		
				H	D	W
	Storage Tower - 2 Box/1 File Drawer	CSPT3-2BFL	2774	39.52	24	24
		CSPT3-2BFR	2774	39.52	24	24

## CSPT - STORAGE TOWERS

- Model CSPT3-2FL has wardrobe section on the left and drawers on the right. compartment, 2 box drawers and 1 file drawer. Locker compartment has one fixed shelf.
- Model CSPT3-2FR has wardrobe section on the right and drawers on the left.
- Includes ventilated 24" D wardrobe section (ventilated on bottom of cabinet), locker • Locking.

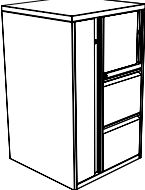
	DESCRIPTION	PRODUCT CODE	LIST PRICE	DIMENSIONS/INCHES		
				H	D	W
	Storage Tower - 2 File Drawers	CSPT3-2FL	2774	39.52	24	24
		CSPT3-2FR	2774	39.52	24	24

## CSPT - STORAGE TOWERS

- Model CSPT4-2BFL has wardrobe section on the left and drawers on the right. compartment, 2 box drawers and 1 file drawer. Locker compartment has one fixed shelf.
- Model CSPT4-2BFR has wardrobe section on the right and drawers on the left.
- Includes ventilated 24" D wardrobe section (ventilated on bottom of cabinet), locker • Locking.

	DESCRIPTION	PRODUCT CODE	LIST PRICE	DIMENSIONS/INCHES		
				H	D	W
	Storage Tower - 2 Box/1 File Drawer	CSPT4-2BFL	2789	51.89	24	24
		CSPT4-2BFR	2789	51.89	24	24

# STORAGE

## CSPT - STORAGE TOWERS

- Model CSPT4-2FL has wardrobe section on the left and drawers on the right.
- Model CSPT4-2FR has wardrobe section on the right and drawers on the left.
- Includes ventilated 24"D wardrobe section (ventilated on bottom of cabinet), locker compartment, 2 box drawers and 1 file drawer. Locker compartment has one fixed shelf.
- Locking.

DESCRIPTION	PRODUCT CODE	LIST PRICE	DIMENSIONS/INCHES		
			H	D	W
Storage Tower - 2 File Drawers	CSPT4-2FL	2789	51.89	24	24
	CSPT4-2FR	2789	51.89	24	24

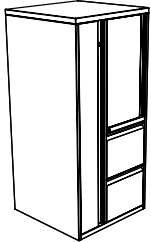

## CSPT - STORAGE TOWERS

- Model CSPT5-2BFL has wardrobe section on the left and drawers on the right.
- Model CSPT5-2BFR has wardrobe section on the right and drawers on the left.
- Includes ventilated 24"D wardrobe section (ventilated on bottom of cabinet), locker compartment, 2 box drawers and 1 file drawer. Locker compartment has one fixed shelf.
- Locking.

DESCRIPTION	PRODUCT CODE	LIST PRICE	DIMENSIONS/INCHES		
			H	D	W
Storage Tower - 2 Box/1 File Drawe	CSPT5-2BFL	2862	66.39	24	24
	CSPT5-2BFR	2862	66.39	24	24

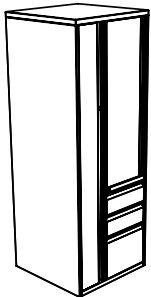

## CSPT - STORAGE TOWERS

- Model CSPT5-2FL has wardrobe section on the left and drawers on the right.
- Model CSPT5-2FR has wardrobe section on the right and drawers on the left.
- Includes ventilated 24"D wardrobe section (ventilated on bottom of cabinet), locker compartment, 2 box drawers and 1 file drawer. Locker compartment has one fixed shelf.
- Locking.

DESCRIPTION	PRODUCT CODE	LIST PRICE	DIMENSIONS/INCHES		
			H	D	W
Storage Tower - 2 File Drawers	CSPT5-2FL	2862	66.39	24	24
	CSPT5-2FR	2862	66.39	24	24

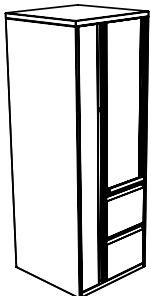

# STORAGE

# STORAGE - KEY ALIKE FORM

SO# \_\_\_\_\_ PO# \_\_\_\_\_ TAG# \_\_\_\_\_ Date \_\_\_\_\_

KEY#	SETS REQ'D	KEY#	SETS REQ'D	KEY#	SETS REQ'D	KEY#	SETS REQ'D	KEY#	SETS REQ'D
401		431		461		491		521	
402		432		462		492		522	
403		433		463		493		523	
404		434		464		494		524	
405		435		465		495		525	
406		436		466		496		526	
407		437		467		497		527	
408		438		468		498		528	
409		439		469		499		529	
410		440		470		500		530	
411		441		471		501		531	
412		442		472		502		532	
413		443		473		503		533	
414		444		474		504		534	
415		445		475		505		535	
416		446		476		506		536	
417		447		477		507		537	
418		448		478		508		538	
419		449		479		509		539	
420		450		480		510		540	
421		451		481		511		541	
422		452		482		512		542	
423		453		483		513		543	
424		454		484		514		544	
425		455		485		515		545	
426		456		486		516		546	
427		457		487		517		547	
428		458		488		518		548	
429		459		489		519		549	
430		460		490		520		550	

401-430 =	431-460 =	461-490 =	491-520 =	521-550 =
-----------	-----------	-----------	-----------	-----------

Total: \_\_\_\_\_

NOTE : If Key Alike Instructions are not submitted to EVOLVE with the Customer's Purchase Order, all components will be keyed randomly.

